



CATALOGO GENERALE
2021



Edizione XIII - 2021

Index

BRICK GENERATION - Effetto Mattone

Bristol	17
Le Lacche	25
London	31
New York	41
Noho	53
Skyline	47
Soho	53
Solid	63
The Wall	69
Tribeca	75
Urban&Colors	83

3D

Asiago	93
Cubics	99
Gioia	105
Inwood 3D	111
Loft 3D	117
Lyon	125
Palissandro 3D	131
Quarzi 3D	137
Tiffany	143
Timeless 3D	149
Volcano 3D	157
Wall Art	163

FORESTA DI GRES - Effetto Legno

Aspen	171
Bricola	181
Cottage	191

Daring	199
Ever	217
Greenwood	227
Hard & Soft	237
Inwood	247
Living	257
Renaissance	267
Tabula	277
Timeless	289
Vintage	305
Woodie	311

PIETRE E MARMI

Ardesie	323
Aurelia	333
Baltic	339
Bluestone	351
Canova	355
Contract	367
Emilia	375
Le Cave	381
Piasentina	391
Pietra di Panama	395
Pietre di Fiume	405
Provence	413
Quarzi	427
Sandstones	435
Terre d'Otranto	441
Valeria	449
Valsertal Stone	457

LE MATERIE - Effetto cemento, cotto, metallo

Bristol Effetto Cotto - Cotto	467
Concrete Effetto Cemento - Cement	473
Docks Effetto Cemento - Cement	489
Icon Effetto Cemento - Cement	499
Industrial Color Chic Effetto Cemento - Cement	515
Loft Effetto Cemento - Cement	525
London Effetto Cotto - Cotto	557
Manhattan Effetto Cotto - Cotto	563
Murales Effetto Cemento - Cement	573
Oxyd Effetto Metallo - Metal	585
Rust Effetto Metallo - Metal	595
Swing Effetto Cemento - Cement	605
Tuscany Effetto Cotto - Cotto	615
Volcano Effetto Cemento - Cement	623

COLLEZIONI METROPOLITANE

Cobblewood	640
Decking	642
Doghe	644
Jungle	647
Visual	653

BATTISCOPIA

Tutte le serie - All series	661
-----------------------------	-----

H2O - Spessorato

Ardesie	323
Aurelia	333
Bluestone	351
Concrete	473
Emilia	375
Greenwood	227
Hard & Soft	237
Le Cave	381
Loft	525
Provence	413
Sandstones	435
Terre d'Otranto	441
Timeless	289
Valeria	449
Valsertal Stone	457
Volcano	623

Index

R9 - A

Bricola	181
Canova <small>Naturale</small>	355
Cottage	191
Loft <small>Lappato</small>	525
Oxyd	585
Rust	595
Terre d'Otranto	441
Tuscany	615
Vintage	305

R9 - B

Living	257
--------	-----

R10 - A

Ever	217
Inwood	247
Jungle	647
Pietre di Fiume	405
Swing	605
Tabula	277
Valsertal Stone	457
Woodie	311

R10 - B

Aspen	171
Ardesie	323
Baltic	339
Bristol <small>17x34 e 34x34</small>	467
Cobblewood	640
Concrete	473
Contract	367
Daring	199
Docks	489
Greenwood	227
Icon	499
Industrial Color Chic	515
Living <small>7,5x45</small>	257
Loft <small>Naturale e Strutturato R10</small>	525
London <small>30x60</small>	31
London <small>30,5x60,5</small>	557
Manhattan	563
Murales	573
Piasentina	391
Pietra di Panama	395
Provence	413

Renaissance	267
Timeless	289
Urban&Colors	83
Visual	653
Volcano	623

R10 - C

Hard & Soft	237
Quarzi	427

R11 - B

Bristol <small>6x25</small>	17
Tabula <small>Grip</small>	277

R11 - C

Ardesie <small>h20 e Strong</small>	323
Aspen <small>Strong</small>	171
Aurelia	333
Baltic <small>Grip</small>	339
Bluestone	351
Concrete <small>Grip e h20</small>	473
Daring <small>Grip e Strong</small>	199
Decking	642
Doghe	644
Emilia	375
Greenwood <small>Grip, Strong e h20</small>	227
Hard & Soft <small>15x61 e h20</small>	237
Le Cave	381
Loft <small>Strong e h20</small>	525
London <small>6x25 + 13x25</small>	31
New York	41
Pietra di Panama <small>Strong</small>	395
Pietre di Fiume <small>Strong</small>	405
Provence <small>Strong e h20</small>	413
Quarzi <small>Grip e 20,3x20,3 e 20,3x40,6</small>	427
Sandstones	435
Terre d'Otranto <small>Grip</small>	441
The Wall	69
Timeless <small>Grip e h20</small>	289
Tribeca	75
Tuscany <small>Strong</small>	615
Valeria	449
Valsertal Stone <small>h20</small>	457
Volcano <small>h20</small>	623

Size Index

6x25 (2 1/3"x10")

Bristol	17
London	31
New York	41
Noho	53
Skyline	47
Soho	53
The Wall	69
Tribeca	75
Urban&Colors	83

6,1x37 (2 2/5"x14 1/2")

Le Lacche	25
Oxyd	585
Solid	63

7,5x40,7 (3"x16") Chevron

Vintage	305
Woodie	311

7,5x45 (3"x18")

Greenwood	227
Inwood	247
Living	257
Vintage	305
Woodie	311

13x25 (5"x10")

London	31
--------	----

15x61 (6"x24")

Asiago	93
Cubics	99
Daring	199
Gioia	105
Greenwood	227
Hard & Soft	237
Inwood 3D	111
Jungle	647
Living	257
Loft 3D	117
Lyon	125
Palissandro 3D	131
Quarzi 3D	137
Tabula	277
Tiffany	143
Timeless 3D	149
Visual	653
Volcano 3D	157
Wall Art	163

15x100 (6"x39 1/2")

Aspen	171
Hard & Soft	237

Inwood	247
--------	-----

Living	257
--------	-----

Tabula	277
--------	-----

17x34 (7"x13 1/2")

Bristol	467
---------	-----

20x20 (8"x8")

Bluestone <small>h20</small>	351
------------------------------	-----

Le Cave <small>h20</small>	381
----------------------------	-----

Terre d'Otranto <small>h20</small>	441
------------------------------------	-----

20,3x20,3 (8"x8")

La Cave	381
---------	-----

Provence	413
----------	-----

Quarzi	427
--------	-----

Swing	605
-------	-----

20x30 (8"x12")

Bluestone <small>h20</small>	351
------------------------------	-----

Le Cave <small>h20</small>	381
----------------------------	-----

Terre d'Otranto <small>h20</small>	441
------------------------------------	-----

20,3x40,6 (8"x16")

Le Cave	381
---------	-----

Provence	413
----------	-----

Quarzi	427
--------	-----

Tuscany	615
---------	-----

20x80 (8"x32")

Loft	525
------	-----

20,5x100 (8"x39 1/2")

Aspen	171
-------	-----

Hard & Soft	237
-------------	-----

Living	257
--------	-----

20x120 (8"x48")

Bricola	181
---------	-----

Cottage	191
---------	-----

Ever	217
------	-----

Oxyd	585
------	-----

Pietra di Panama	395
------------------	-----

Timeless	289
----------	-----

22,5x90 (8 3/4"x35 2/4")

Icon	499
------	-----

24x120 (9 1/2"x48")

Daring	199
--------	-----

Greenwood	227
-----------	-----

Woodie	311
--------	-----

24x150 (9 1/2"x59")

Renaissance	267
-------------	-----

Timeless	289
----------	-----

26,5x180 (10 1/2"x70 7/8")

Daring	199
--------	-----

30,5x60,5 - 30x60 (12"x24")

Ardesie	323
---------	-----

Baltic	339
--------	-----

Canova	355
--------	-----

Concrete	473
----------	-----

Contract	367
----------	-----

Icon	499
------	-----

Industrial Color Chic	515
-----------------------	-----

Le Cave	381
---------	-----

Loft	525
------	-----

London	557
--------	-----

Oxyd	585
------	-----

Piasentina	391
------------	-----

Pietra di Panama	395
------------------	-----

Pietre di Fiume	405
-----------------	-----

Provence	413
----------	-----

Quarzi	427
--------	-----

Rust	595
------	-----

Terre d'Otranto	441
-----------------	-----

Valsertal Stone	457
-----------------	-----

Volcano	623
---------	-----

30x120 (12"x48")

Bricola	181
---------	-----

Ever	217
------	-----

Timeless	289
----------	-----

34x34 (13 1/2"x13 1/2")

Bristol	467
---------	-----

Cobblewood	640
------------	-----

Decking	642
---------	-----

Doghe	644
-------	-----

40x80 (16"x31 1/2")

Concrete	473
----------	-----

Docks	489
-------	-----

Loft	525
------	-----

Manhattan	563
-----------	-----

Murales	573
---------	-----

40x120 (16"x48")

Ardesie <small>h20</small>	323
----------------------------	-----

Greenwood <small>h20</small>	227
------------------------------	-----

Hard & Soft <small>h20</small>	237
--------------------------------	-----

Le Cave <small>h20</small>	381
----------------------------	-----

Timeless <small>h20</small>	289
-----------------------------	-----

40,6x40,6 (16"x16")

Le Cave	381
---------	-----

Terre d'Otranto	441
-----------------	-----

Tuscany	615
---------	-----

45x90 (17 3/4"x35 2/4")

Icon	499
------	-----

51,6x27,2 (20"x11")

The Wall	69
----------	----

60,5x60,5 - 60x60 (24"x24")

Ardesie	323
---------	-----

Aurelia	333
---------	-----

Baltic	339
--------	-----

Canova	355
--------	-----

Concrete	473
----------	-----

Contract	367
----------	-----

Emilia	375
--------	-----

Icon	499
------	-----

Industrial Color Chic	515
-----------------------	-----

Loft	525
------	-----

Oxyd	585
------	-----

Pietre di Fiume	405
-----------------	-----

Provence	413
----------	-----

Quarzi	427
--------	-----

Rust	595
------	-----

Terre d'Otranto	441
-----------------	-----

Valeria	449
---------	-----

Volcano	623
---------	-----

60x100 (24"x39 1/2")

Valsertal Stone <small>h20</small>	457
------------------------------------	-----

Provence <small>h20</small>	413
-----------------------------	-----

Sandstones <small>h20</small>	435
-------------------------------	-----

60x120 (24"x48")

Ardesie	323
---------	-----

Baltic	339
--------	-----

Canova	355
--------	-----

Concrete	473
----------	-----

Docks	489
-------	-----

Industrial Color Chic	515
-----------------------	-----

Murales	5
---------	---



1961

Nel 1961, nasceva Rondine S.p.A., nucleo fondante dell'attuale Ceramica Rondine, leader internazionale nella produzione di ceramiche per pavimenti, rivestimenti e battiscopa in gres porcellanato.

1961 saw the foundation of Rondine S.p.A., the core that grew into today's leader Ceramica Rondine, in the production of porcelain stoneware tiles for floors, walls and skirtings.

1997

Il 1997 è un anno di svolta, con l'ingresso di un nuovo management che imprime un nuovo impulso a livello gestionale, commerciale e produttivo.

1997 marked a watershed, with the entry of a new management team, bringing a fresh injection of energy into business, production and management.

2001

Nel settembre del 2001 viene inaugurato l'impianto di produzione della sede di Rubiera, completamente rinnovato, tecnologicamente avanzato, dedicato alla produzione di gres porcellanato.

September 2001 saw the inauguration of the porcelain stoneware manufacturing plant in Rubiera. Renewed throughout and featuring cuttingedge technology.

2005

È del maggio 2005 l'acquisizione di SprayDry, azienda sassolese produttrice di atomizzato, che consente a Ceramica Rondine di compiere un importante salto di qualità realizzando in questo modo l'intero ciclo produttivo della piastrella.

May 2005 saw the acquisition of SprayDry, a Sassuolo company that produces porcelain stoneware bodies, thus allowing Ceramica Rondine to make a major leap forward in terms of quality by covering the full tile production cycle in its own plants.

2010

Sadon, azienda leader nella produzione di piccoli formati in gres porcellanato, entra in Ceramica Rondine nel 2010, segnando un'ulteriore e preziosa svolta nella storia di Ceramica Rondine.

Sadon, a leading company in the production of porcelain stoneware small-size tiles, joined the Ceramica Rondine in 2010, marking a further important turning point in the history of Ceramica Rondine.

2011

Nuovo assetto societario nel Dicembre 2011. Lauro Giacobazzi e famiglia, ed il fondo di private equity PROGRESSIO SGR, già soci di riferimento, hanno acquisito la totalità delle azioni di Ceramica Rondine S.p.A.

New shareholding structure in December 2011. Lauro Giacobazzi and family, and the private equity fund PROGRESSIO SGR, already the main shareholders, purchases 100% of the shares of Ceramica Rondine S.p.A.

2013

È il giugno del 2013 quando il fondo private equity PROGRESSIO SGR cede le proprie azioni a Seramiksan, uno dei maggiori produttori di ceramica in Turchia. L'azienda ha una forte tradizione industriale ben radicata sul territorio di Turgutlu- Manisa, situata a soli 50 km da Izmir.

In June 2013, the private equity fund PROGRESSIO SGR transferred its shares to Seramiksan, one of the largest ceramic manufacturers in Turkey. The company boasts a long industrial tradition, deeply rooted in the Turgutlu-Manisa area, just 50 km from Izmir.

2015

Agennaio 2015 si concretizzano importanti investimenti con l'ampliamento di un'unità produttiva, con una nuova linea per la movimentazione dei grandi formati, macchine per la scelta automatica e linee di confezionamento di ultima generazione.

In January 2015, significant investments were made, with the extension of a production facility, new lines for handling large sizes, automatic sorting lines and latest-generation packing lines.



2016-2017

Con oltre 100 collezioni disponibili in una vastissima scelta di linee e formati Ceramica Rondine vanta anche la più ampia gamma di battiscopa in gres porcellanato. Nel 2016 sono stati previsti importanti investimenti che si sono concretizzati nei primi mesi del 2017. Questi investimenti hanno potenziato e ottimizzato i processi produttivi, permettendo così anche la produzione di grandi formati, dall' 80x80 al 120x120 e la possibilità di una maggior competitività sui mercati internazionali.

With more than 100 collections available in a wide range of designs and sizes, Ceramica Rondine also boasts a wide range of porcelain stoneware skirting tiles. In 2016 extensive investments were planned and implemented in early 2017. These investments increased and optimised the production processes, thus also leading to the production of large sizes, from 80x80 to 120x120, and allowed the company to increase its competitive performance on international markets.

2018

Nell'ottobre 2018 **Italcer Group**, società capogruppo dell'omonimo Gruppo ceramico controllato dal fondo italiano di private equity **Mandarin Capital Partners II** e **Graziano Verdi**, ha completato l'acquisizione del 100% di **Ceramica Rondine**. Questa acquisizione segue quelle di **La Fabbrica S.p.A.**, **Elios Ceramica S.p.A.** e **Devon&Devon S.p.A.**, concluse nel 2017.

Con Rondine, il Gruppo Italcer si va a posizionare, con **200 milioni di euro** di fatturato aggregato ai primi posti tra gli operatori italiani del settore. L'ingresso di Rondine nel Gruppo Italcer porterà l'azienda a dotarsi di nuovi strumenti e sinergie in grado di ritagliarsi un ruolo sempre più da protagonista sui mercati domestici e internazionali.

In October 2018 Italcer Group, parent company of the ceramic group of the same name controlled by the Italian private equity fund Mandarin Capital Partners II and Graziano Verdi, completed the 100% takeover of Ceramica Rondine.

This acquisition follows those of La Fabbrica Spa, Elios Ceramica Spa and Devon&Devon Spa, which were completed in 2017. With Rondine, the Italcer Group, with aggregate turnover of 200 million EUR, among first places in the league table of Italian ceramics manufacturers.

The entry of Rondine in the Italcer Group will allow the company to equip itself with new instruments and synergies that allow it to develop an increasingly leading role in domestic and international markets.

2020

Il 2020 porta in dote l'acquisizione di **Cedir - Ceramiche di Romagna**, un'azienda storica del territorio Ravennate che va ad ampliare il polo Romagnolo del gruppo.

Viene anche presentata l'innovativa tecnologia **ADVANCE**, una ceramica eco-compatibile in gres porcellanato, in primo ed unico fuoco, ad oltre 1230 gradi di cottura e con il 40% di materie prime riciclate sia per soluzioni residenziali che non residenziali.

Advance grazie alle sue proprietà **antivirali**, **antibatteriche** e **fotocatalitiche** è capace di proteggere maggiormente gli ambienti che ci circondano rendendoli più salubri e riducendo significativamente l'inquinamento.

2020 brings the new acquisition of Cedir - Ceramiche di Romagna, an historical company located in Ravenna, in order to expand the group hub in the Romagna area.

Moreover, we have also presented the innovative ADVANCE technology, an eco-friendly ceramic in porcelain stoneware, in first and single fire, at over 1230 degrees of cooking and with 40% of recycled raw materials for both residential and non-residential solutions. Thanks to its antiviral, antibacterial and photocatalytic properties, Advance is able to protect the surrounding environments, making them healthier and reducing significantly the pollution.

CERAMICA RONDINE È GREEN

Ceramica Rondine is green

Produrre piastrelle di qualità e rispettare l'ambiente è possibile. **Ceramica Rondine** ha scelto la strada dello sviluppo sostenibile, della produzione industriale ecocompatibile, nella convinzione che la tutela delle risorse, dell'aria, dell'acqua e del suolo siano condizioni indispensabili per il nostro futuro.

Per questo motivo ha deciso volontariamente di organizzare il controllo degli impatti ambientali legati al processo produttivo secondo le direttive **UNI EN ISO 14001 e 50001**. **Ceramica Rondine** si è inoltre impegnata a comunicare all'esterno, attraverso la Dichiarazione Ambientale redatta in conformità a quanto stabilito dal regolamento europeo **EMAS**, le azioni attuate in tal senso.

*The production of quality tiles in respect of the environment is possible. **Ceramica Rondine** has chosen the path of sustainable development and environmentally compatible industrial production, in the belief that the safeguarding of resources, air, water and the soil are essential conditions for our future.*

*For this reason it has voluntarily decided to organize the monitoring of environmental impacts related to its production process as specified in the directive **UNI EN ISO 14001 and 50001**. **Ceramica Rondine** is also committed to announcing the actions taken in this regard, through the Environmental Statement issued in accordance with the provisions set by the European **EMAS** Regulation.*

L'IMPEGNO DI CERAMICA RONDINE PER UNO SVILUPPO SOSTENIBILE

Ceramica Rondine's commitment to sustainable development

- Controllo della provenienza delle materie prime minerali;
- Ottimizzazione dei consumi di energia e acqua;
- Monitoraggio continuo degli impianti di rotazione ambientale (in particolare quello di abbattimento delle emissioni in atmosfera);
- Adozione di piani di sorveglianza ambientale;
- Ottimizzazione della gestione dei rifiuti;
- Adozione di pratiche di movimentazione e deposito di minor impatto ambientale;
- Predisposizione di piani di prevenzione ed emergenza ambientale, compresa la formazione degli operatori coinvolti.
- Control of the origin of mineral raw materials;
- Optimization of energy and water consumption;
- Continuous monitoring of environmental protection systems (in particular for the reduction of emissions into the atmosphere);
- Adoption of environmental monitoring plans;
- Optimization of waste management;
- Adoption of handling and storage methods with a reduced environmental impact;
- Arrangement of prevention and environmental emergency plans, including the training of the operating staff involved.



ARIA

Air

Il riciclaggio di materiale di scarto riduce del **49%** le distanze da percorrere per trasportare le materie prime:

- **6.300.000 Km in meno ogni anno;**
- **1.000 tonnellate di CO² non immesse in atmosfera** (occorrerebbero 25.000 alberi su una superficie pari a 28 campi da calcio, per compensare l'immissione di CO² nell'ambiente).
- Nel 2019 inoltre è stato installato il più recente post-combustore che elimina completamente le sostanze organiche (SOV) fonte delle emissioni odorogene altrimenti emesse in atmosfera.

• *We reduced by **49%** the distances involved in transporting raw materials thanks to our intensive recycling of waste:*

- **6.300.000 Km less per year;**
- **1.000 tonnes of CO² not released into the atmosphere** (it would take 25.000 trees over an area of 28 football fields, to compensate for the release of CO² into the environment).
- *Furthermore, in 2019 the most recent post-combustor was installed. It contributes in eliminating organic substances (SOV), that are the source of odorous emissions and that would be otherwise emitted in the atmosphere.*



ACQUA

Water

Importanti investimenti in impianti di depurazione e corsi di formazione indirizzati alle risorse umane, hanno ridotto i consumi idrici del **62%** rispetto alla media del settore:

- **10.000 m³ di acqua in meno ogni anno** (pari al consumo di 50 famiglie).

*Major investments in waste water treatment plants and training courses for employees, reduced water consumption by **62%** compared to industry average:*

- **10.000 m³ less water consumption per year** (the same consumption of 50 families).



TERRA

Earth

Per la produzione delle nostre piastrelle, i moderni impianti di macinazione generano argille composte per il **50%** da scarti di lavorazione provenienti da aziende ceramiche:

- **32.000 m³ di argilla in meno ogni anno** (pari a 3 volte il volume della Torre di Pisa).

*To produce our tiles, modern plants generate clays consisting of **50%** from scraps from ceramic factories:*

- **32.000 m³ of clay from quarries less each year** (equal to 3 times the volume of Tower of Pisa).

INDUSTRIA 4.0

Industry 4.0



Le immagini di queste 2 pagine sono tratte dai nostri stabilimenti di Rubiera ed evidenziano solo alcune parti degli investimenti per realizzare una **industria 4.0** all'avanguardia per tecnologia, processi, rispetto ambientale e capitale umano altamente specializzato.

*The images of these 2 pages are taken from our Rubiera factories and they highlight only some of the investments we have done to create a **4.0 industry**, which is at the forefront of technology, procedures, environmental respect and highly specialized human capital.*



BRICK GRES GENERATION

“ Ceramica Rondine ha lanciato per prima sul mercato il gres porcellanato effetto mattone. Brick Generation, è una perfetta sintesi di contemporaneità e fascino atemporale. Parliamo infatti di un rivestimento che riproduce con impressionante fedeltà la superficie e la resa tattile del mattone. La sua ruvidità, un'intensità materica senza precedenti, viene proposta e declinata in un'ampia tavolozza cromatica che fa rivivere l'affascinante essenza del mattoncino. Affidarsi alla personalizzazione degli spazi in ottica brick ci consente poi di giocare con pochi e semplici oggetti per mettere a punto un look 100% urban. ”

Ceramica Rondine has developed a new collection: Brick Generation, a perfect blend of contemporary style and timeless appeal. We're looking at a wall covering able to offer an impressively accurate reproduction of the surface and the feel of brick. The rough texture, of an unprecedented material intensity, comes in a wide variety of shades brings the marvellous essence of brick right back to life. This focus on bringing a personal touch to settings with a brickwork twist allows us to experiment with a few simple objects to create a 100% urban look.

Ceramica Rondine propose une nouvelle collection qui s'appelle Brick Generation et qui est une synthèse parfaite entre contemporanéité et charme atemporel. Nous parlons en effet d'un revêtement qui reproduit, avec une fidélité impressionnante, la surface et le résultat tactile de la brique. Sa rugosité, une intensité matiériste sans précédents, est proposée et déclinée dans une vaste palette chromatique qui fait revivre la fascinante essence de la brique. S'en remettre à la personnalisation des espaces dans une optique de 'briques' nous permet aussi de jouer avec quelques objets simples afin d'élaborer un look 100% urbain.

Ceramica Rondine hat eine neue Kollektion entwickelt: sie heißt Brick Generation und ist eine perfekte Verbindung aus Zeitgemäßheit und zeitloser Faszination. So sprechen wir von einer Verkleidung, die die Oberfläche und die Beschaffenheit von Ziegel bei der Berührung mit erstaunlicher Wirklichkeitstreue nachahmt. Ihre Rauheit, eine beispiellose intensive Beschaffenheit, wird in einer breiten Farbpalette angeboten und ausgearbeitet das faszinierende Wesen des Ziegelsteins nacherleben lässt. Indem wir uns der persönlichen Gestaltung der Räume mit der Brick-Optik anvertrauen, erhalten wir die Möglichkeit, danach mit einigen wenigen einfachen Gegenständen zu spielen, um einen 100%-Urban-Look zu perfektionieren.

Bristol	17	Soho	53
Le Lacche	25	Solid	63
London	31	The Wall	69
New York	41	Tribeca	75
Noho	53	Urban&Colors	83
Skyline	47		



wall
Bristol - Red 6x25

[Back to Index](#)

BRISTOL



DARK



RUST



CREAM



RED



UMBER



GRES PORCELLANATO SMALTATO
GLAZED PORCELAIN STONEWARE
GRES CERAME EMAILLE
GLASIERTESFEINSTEINZEUG

Coordinato con:
Coordinated with:
BRISTOL
SEZ. LE MATERIE
PG. 467



6x25
2 1/3"x10"

IN OUT R11
B

dark



J85668
6x25 (2 1/3"x10")

firma dark



J85999
6x25 (2 1/3"x10")

Coordinato con:
Coordinated with:
BRISTOL
SEZ. LE MATERIE
PG. 467



J85530
34x34 (13 1/2"x13 1/2")



J85535
17x34 (7"x13 1/2")

Abbinamenti suggeriti
Suggested matchings
Combinaison conseillée
Kombinationsvorschläge



IN OUT R11
B

rust



J85670
6x25 (2 1/3"x10")

firma rust



J86001
6x25 (2 1/3"x10")

Coordinato con:
Coordinated with:
BRISTOL
SEZ. LE MATERIE
PG. 467



J85532
34x34 (13 1/2"x13 1/2")



J85537
17x34 (7"x13 1/2")

Abbinamenti suggeriti
Suggested matchings
Combinaison conseillée
Kombinationsvorschläge

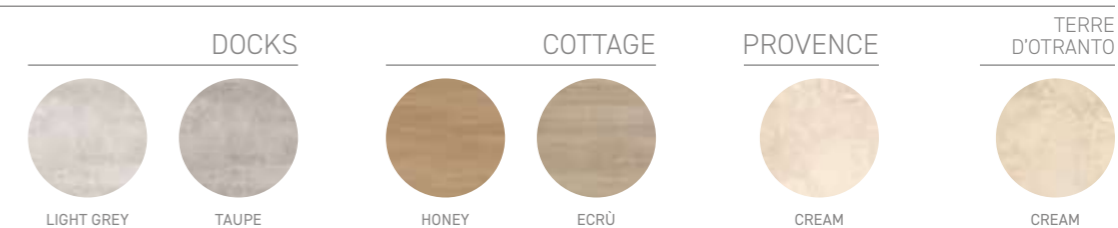

IN OUT R11
B

cream



J85667
6x25 (2 1/3"x10")

firma cream



J85998
6x25 (2 1/3"x10")

Coordinato con:
Coordinated with:
BRISTOL
SEZ. LE MATERIE
PG. 467



J85529
34x34 (13 1/2"x13 1/2")



J85534
17x34 (7"x13 1/2")

Abbinamenti suggeriti
Suggested matchings
Combinaison conseille
Kombinationsvorschläge



IN OUT R11
B

red



J85669
6x25 (2 1/3"x10")

firma red



J86000
6x25 (2 1/3"x10")

Coordinato con:
Coordinated with:
BRISTOL
SEZ. LE MATERIE
PG. 467



J85531
34x34 (13 1/2"x13 1/2")



J85536
17x34 (7"x13 1/2")

Abbinamenti suggeriti
Suggested matchings
Combinaison conseille
Kombinationsvorschläge



IN OUT R11/B

umber

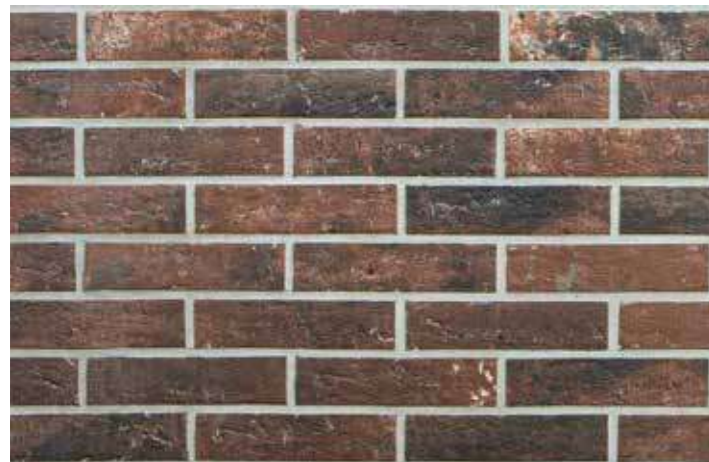

J85671
6x25 (2 1/3"x10")

firma umber



J86002
6x25 (2 1/3"x10")

Coordinato con:
Coordinated with:
BRISTOL
SEZ. LE MATERIE
PG. 467



J85533
34x34 (13 1/2"x13 1/2")



J85538
17x34 (7"x13 1/2")

Abbinamenti suggeriti
Suggested matchings
Combinaison conseillée
Kombinationsvorschläge

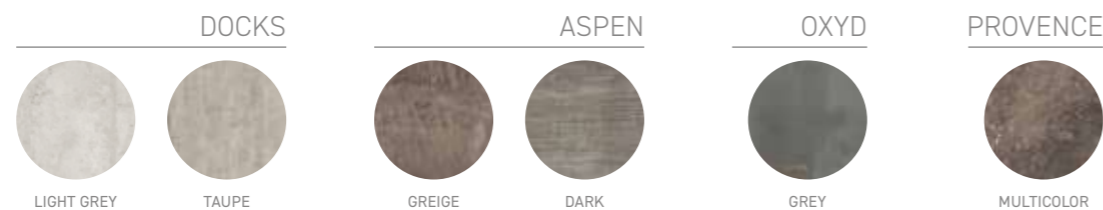

red sviluppo grafico 6x25 (2 1/3"x10")



62 6x25
GRAFICHE DIVERSE
DIFFERENT PATTERNS
DIFFÉRENTS MOTIFS
VERSCHIEDENE MUSTER

	6x25 (2 1/3"x10")	Firma 6x25 (2 1/3"x10")	Angolo Incollato 12x25x6 (4 3/4"x10"x2 1/3")	Angolo monolitico 4x17x6 (1 3/4"x7"x2 1/3")	34x34 (13 1/2"x13 1/2")	17x34 (7"x13 1/2")
DARK	J85668	J85999	J85700	J85960	J85530	J85535
RUST	J85670	J86001	J85702	J85962	J85532	J85537
CREAM	J85667	J85998	J85699	J85959	J85529	J85534
RED	J85669	J86000	J85701	J85961	J85531	J85536
UMBER	J85671	J86002	J85703	J85963	J85533	J85538
SPESSORE THICKNESS	9,5 mm	9,5 mm	9,5 mm	9,5 mm	8,5 mm	8,5 mm
KG/M²	16,9	16,9	16,9	16,9	16,1	16,1
PZ/BOX	32	3	12	10	11	23
M²/BOX	0,58 *	-	-	-	1,27	1,35
BOX/PALLET	100	-	-	-	48	48
M²/PALLET	58	-	-	-	60,96	64,8
KG/PALLET	980,2	-	-	-	982	1043,3
€ <1 PALLET	64,90/m²	11,70 pz./p.ce	15,00 pz./p.ce	9,70 pz./p.ce	39,60/m²	39,60/m²
€ >1 PALLET	56,40/m²	11,70 pz./p.ce	15,00 pz./p.ce	9,70 pz./p.ce	33,00/m²	33,00/m²

Contributo spese imballo € 10,00/pal (netto). - Packing charges € 10,00/pal (net)

* Compresa fuga di 1 cm - 1 cm joint included

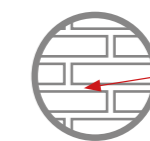

POSARE CON FUGA DI 1 CM
LAY WITH 1 CM JOINT
POSER AVEC UN JOINT DE 1 CM
MIT EINER 1 CM FUGE VERLEGEN





Le Lacche - 6,1x37

[Back to Index](#)

LE LACCHE

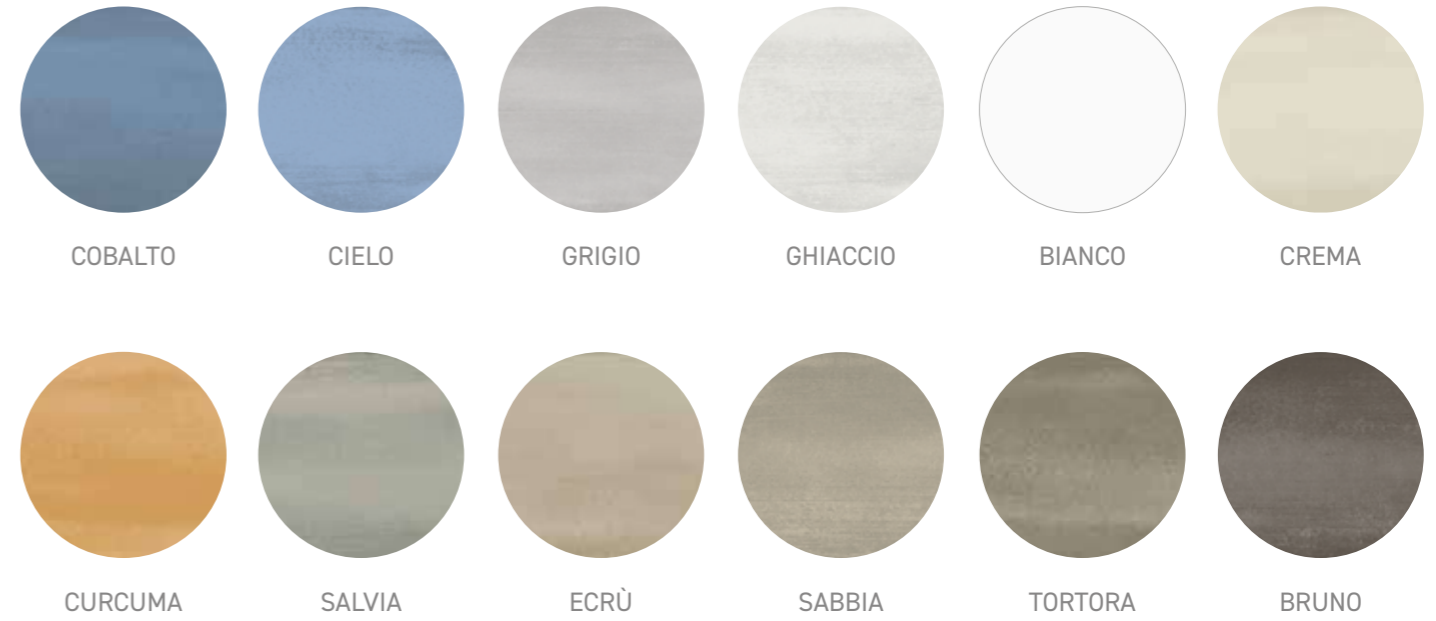

BRICK
GRES GENERATION

GRES PORCELLANATO SMALTATO
GLAZED PORCELAIN STONEWARE
GRES CERAME EMAILLE
GLASIERTESFEINSTEINZEUG

Coordinato con:
Coordinated with:
CONCRETE
SEZ. LE MATERIE
PG. 473

ICC
SEZ. LE MATERIE
PG. 515

8 mm

6,1x37
2 2/5"x14 1/2"



cobalto

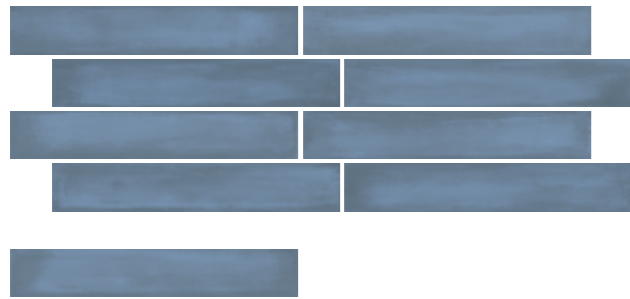

J88358
6,1x37 (2 2/5"x14 1/2")

cielo

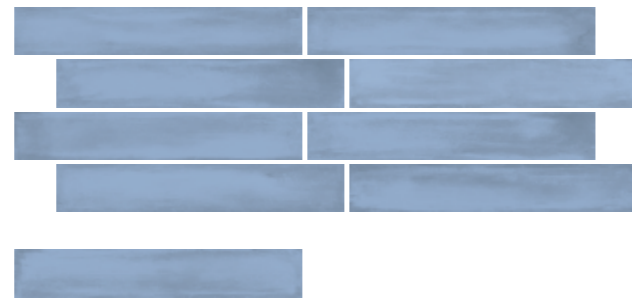

J88357
6,1x37 (2 2/5"x14 1/2")

grigio



J88173
6,1x37 (2 2/5"x14 1/2")

ghiaccio



J88172
6,1x37 (2 2/5"x14 1/2")

bianco

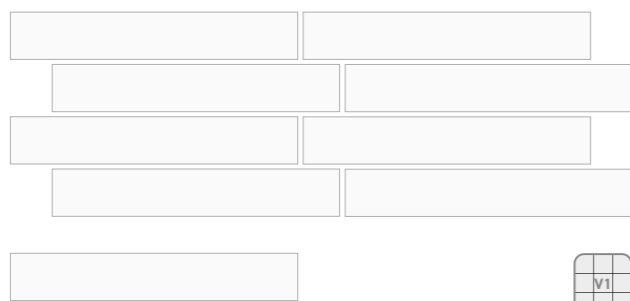

J88170
6,1x37 (2 2/5"x14 1/2")

crema



J88317
6,1x37 (2 2/5"x14 1/2")



Abbinamenti suggeriti
Suggested matchings
Combinaison conseille
Kombinationsvorschläge

CONCRETE



curcuma

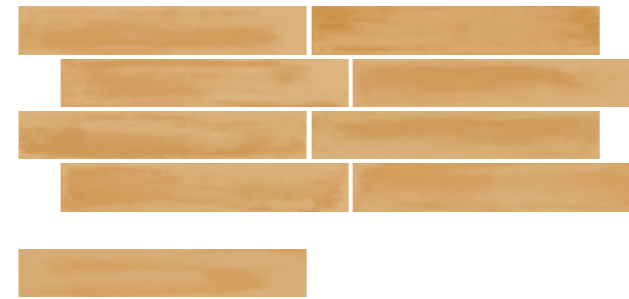

J88359
6,1x37 (2 2/5"x14 1/2")

salvia



J88361
6,1x37 (2 2/5"x14 1/2")

ecrù



J88318
6,1x37 (2 2/5"x14 1/2")

sabbia

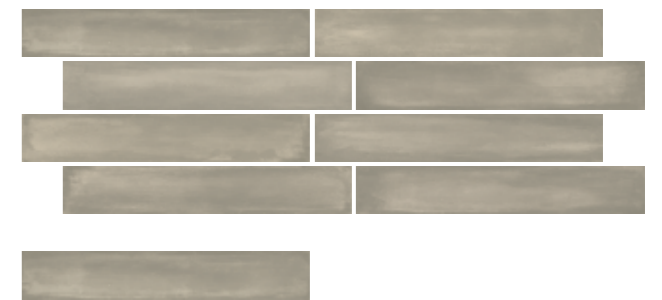

J88174
6,1x37 (2 2/5"x14 1/2")

tortora



J88175
6,1x37 (2 2/5"x14 1/2")

bruno

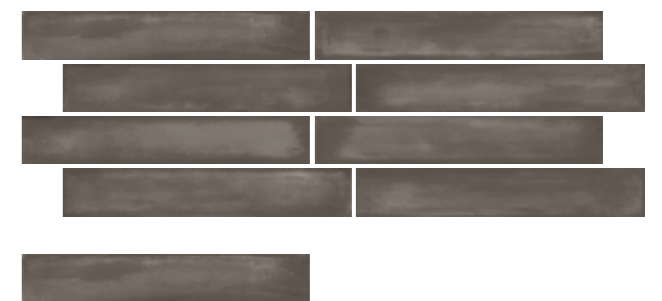

J88171
6,1x37 (2 2/5"x14 1/2")

Abbinamenti suggeriti
Suggested matchings
Combinaison conseille
Kombinationsvorschläge

ICC

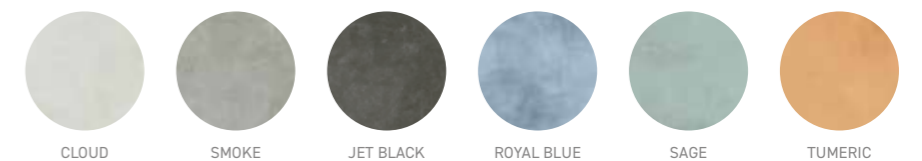

cielo sviluppo grafico 6,1x37 (2 2/5"x14 1/2")

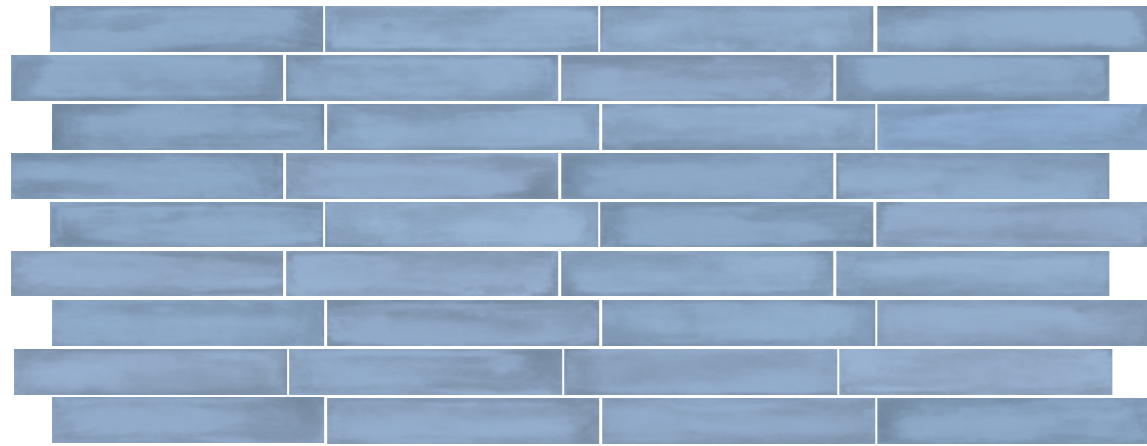

36 6,1x37

GRAFICHE DIVERSE
DIFFERENT PATTERNS
DIFFÉRENTS MOTIFS
VERSCHIEDENE MUSTER



wall
Le Lacche - Cielo 6,1x37
Le Lacche - Cobalto 6,1x37

	6,1x37 (2 2/5"x14 1/2")	Quarter Round 0,8x37 (1/2"x14 1/2")
COBALTO	J88358	J88654
CIELO	J88357	J88653
GRIGIO	J88173	J88680
GHIACCIO	J88172	J88679
BIANCO	J88170	J88652
CREMA	J88317	J88683
CURCUMA	J88359	J88655
SALVIA	J88361	J88657
ECRÙ	J88318	J88684
SABBIA	J88174	J88681
TORTORA	J88175	J88682
BRUNO	J88171	J88678
SPESSORE THICKNESS	8 mm	8 mm
KG/M²	16,1	-
PZ/BOX	48	12
M²/BOX	1,08	-
BOX/PALLET	60	-
M²/PALLET	64,80	-
KG/PALLET	1044	-
€ <1 PALLET	55,70/m²	11,70 pz/pce
€ >1 PALLET	46,40/m²	11,70 pz/pce

Contributo spese imballo € 10,00/pal (netto). - Packing charges € 10,00/pal (net)

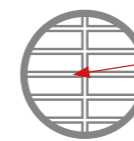

POSARE CON FUGA DI 3 MM
LAY WITH 3 MM JOINT
POSER AVEC UN JOINT DE 3 MM
MIT EINER 3 MM FUGE VERLEGEN

0,15%
 A • HA • LA
 OK
 >50 N/mm²
 6
 5
 Bruno, Tortora
 Sabbia, Crema, Ecrù, Grigio, Curcuma, Salvia, Cielo, Cobalto
 Bianco, Ghiaccio
 R9
 Bianco V1
 V2

Classe III
 Classe IV
 Classe V
 Dcof: Wet 0,48
 Pendulum:
 Dry 50 • Wet 28

LONDON

[Back to Index](#)



CHARCOAL



BROWN

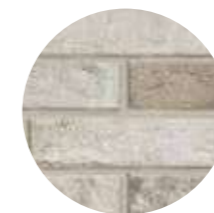

FOG



BEIGE



MULTICOLOR

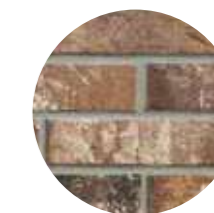

SUNSET



GRES PORCELLANATO SMALTATO
 GLAZED PORCELAIN STONEWARE
 GRES CERAME EMAILLE
 GLASIERTESFEINSTEINZEUG

Coordinato con:
 Coordinated with:
LONDON
 SEZ. LE MATERIE
 PG. 557



9,5 mm



13x25
 5"x10"



6x25
 2 1/8"x10"

wall
 London - Sunset 6x25
 London - Fog 13x25

floor
 Icon - Grey 60x60

IN OUT ^{30x60}R10 ^{6x25}R11
B C

charcoal



J85880
6x25 (2 1/3"x10")

firma charcoal



J86011
6x25 (2 1/3"x10")



J85940
13x25 (5"x10")



Coordinato con:
Coordinated with:
LONDON
SEZ. LE MATERIE
PG. 557

J86017
30,5x60,5 (12"x24")

Abbinamenti suggeriti
Suggested matchings
Combinaison conseillée
Kombinationsvorschläge

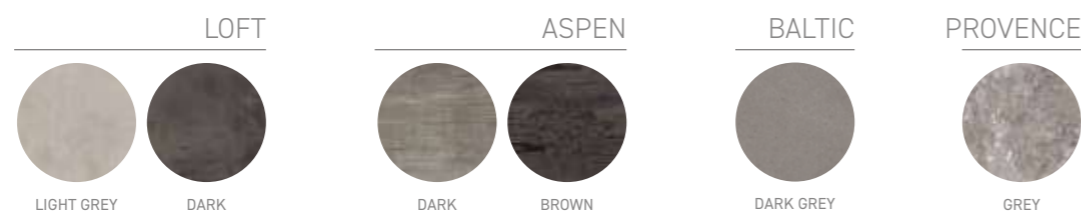

IN OUT ^{30x60}R10 ^{6x25}R11
B C

brown



J85879
6x25 (2 1/3"x10")

firma brown



J86010
6x25 (2 1/3"x10")



J85939
13x25 (5"x10")



Coordinato con:
Coordinated with:
LONDON
SEZ. LE MATERIE
PG. 557

J85945
30,5x60,5 (12"x24")

Abbinamenti suggeriti
Suggested matchings
Combinaison conseillée
Kombinationsvorschläge

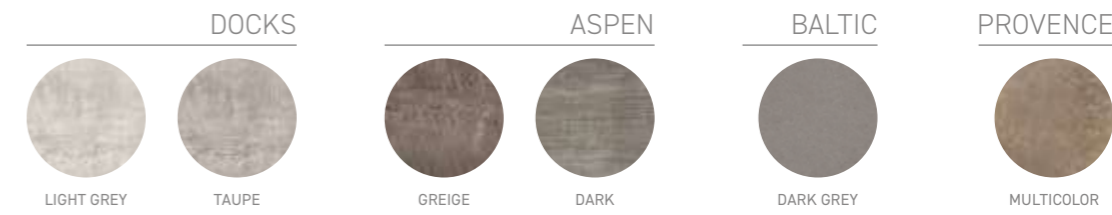

IN OUT ^{30x60}R10/B ^{6x25}R11/C

fog



J85881
6x25 (2 1/3"x10")

firma fog



J86012
6x25 (2 1/3"x10")



J85941
13x25 (5"x10")



Coordinato con:
Coordinated with:
LONDON
SEZ. LE MATERIE
PG. 557

J85946
30,5x60,5 (12"x24")

Abbinamenti suggeriti
Suggested matchings
Combinaison conseillée
Kombinationsvorschläge

PROVENCE

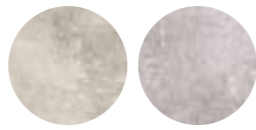

LIGHT GREY TAUPE

GREENWOOD



BIANCO NERO

BALTIC



BEIGE

OXYD



WHITE

IN OUT ^{30x60}R10/B ^{6x25}R11/C

beige



J85878
6x25 (2 1/3"x10")

firma beige



J86009
6x25 (2 1/3"x10")



J85938
13x25 (5"x10")



Coordinato con:
Coordinated with:
LONDON
SEZ. LE MATERIE
PG. 557

J85944
30,5x60,5 (12"x24")

Abbinamenti suggeriti
Suggested matchings
Combinaison conseillée
Kombinationsvorschläge

VOLCANO

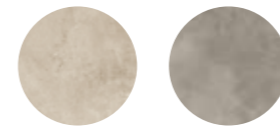

BEIGE TAUPE

DARING



ECRÙ HONEY

TUSCANY



SAN GIMINIANO

BALTIC



DARK GREY

IN OUT ^{30x60}R10 ^{6x25}R11
B C

multicolor



J85877
6x25 (2 1/3"x10")

firma multicolor



J86013
6x25 (2 1/3"x10")

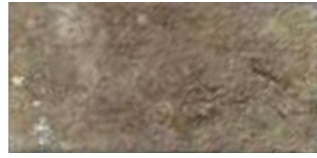
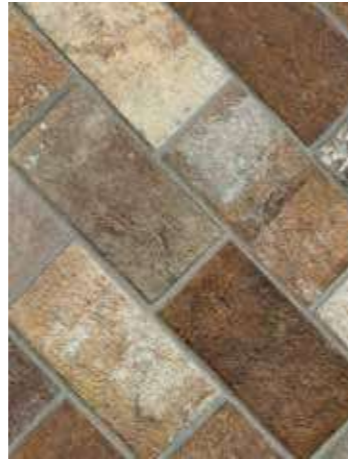

J85942
13x25 (5"x10")

sunset



J85931
6x25 (2 1/3"x10")

firma sunset



J86014
6x25 (2 1/3"x10")



J85943
13x25 (5"x10")

IN OUT ^{30x60}R10 ^{6x25}R11
B C



Coordinato con:
Coordinated with:
LONDON
SEZ. LE MATERIE
PG. 557

J85947
30,5x60,5 (12"x24")

Abbinamenti suggeriti
Suggested matchings
Combinaison conseillée
Kombinationsvorschläge

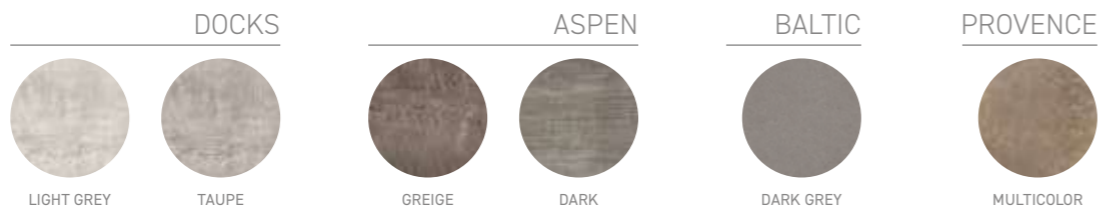

Abbinamenti suggeriti
Suggested matchings
Combinaison conseillée
Kombinationsvorschläge



beige sviluppo grafico 13x25 (5"x10")



66 13x25

GRAFICHE DIVERSE
DIFFERENT PATTERNS
DIFFÉRENTS MOTIFS
VERSCHIEDENE MUSTER

72 6x25

GRAFICHE DIVERSE
DIFFERENT PATTERNS
DIFFÉRENTS MOTIFS
VERSCHIEDENE MUSTER

	6x25 (2 1/4"x10")	13x25 (5"x10")	Firma 6x25 (2 1/4"x10")	Angolo Incollato 12x25x6 (4 3/4"x10"x2 1/3")	Angolo monolitico 4x17x6 (1 3/4"x7"x2 1/3")	Elemento a L Monolitico 15x30,5x4 (6"x12"x1 3/4")	30,5x60,5 (12"x24")
CHARCOAL	J85880	J85940	J86011	J85934	J85955	-	J86017
BROWN	J85879	J85939	J86010	J85933	J85954	J86949	J85945
FOG	J85881	J85941	J86012	J85935	J85956	J86950	J85946
BEIGE	J85878	J85938	J86009	J85932	J85953	J86948	J85944
MULTICOLOR	J85877	J85942	J86013	J85936	J85957	J86951	-
SUNSET	J85931	J85943	J86014	J85937	J85958	J86952	J85947
SPESORE THICKNESS	9,5 mm	9,5 mm	9,5 mm	9,5 mm	9,5 mm	9,5 mm	9,5 mm
KG/M²	16,9	19,23	16,9	16,9	16,9	-	20
PZ/BOX	32	16	3	12	10	8	6
M²/BOX	0,58 *	0,52	-	-	-	-	1,11
BOX/PALLET	100	100	-	-	-	-	48
M²/PALLET	58	52	-	-	-	-	53,28
KG/PALLET	980,2	1000	-	-	-	-	1065,6
€ <1 PALLET	64,90/m²	55,70/m²	11,70 pz/pce	15,00 pz/pce	9,70 pz/pce	16,40 pz/pce	46,10/m²
€ >1 PALLET	56,40/m²	46,40/m²	11,70 pz/pce	15,00 pz/pce	9,70 pz/pce	16,40 pz/pce	38,40/m²

Contributo spese imballo € 10,00/pal (netto). - Packing charges € 10,00/pal (net)

* Compresa fuga di 1 cm - 1 cm joint included

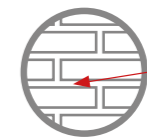

POSARE CON FUGA DI 1 CM
LAY WITH 1 CM JOINT
POSER AVEC UN JOINT DE 1 CM
MIT EINER 1 CM FUGE VERLEGEN

0,3% A • HA • LA OK 46 N/mm² 6 5 Classe IV Classe V R10_B R11_C V4

Charcoal 30x60 6x25 13x25

Dcof: Wet 0,62 Dcof: Wet 0,65
Pendulum: Pendulum:
Dry 51 • Wet 42 Dry 55 • Wet 48

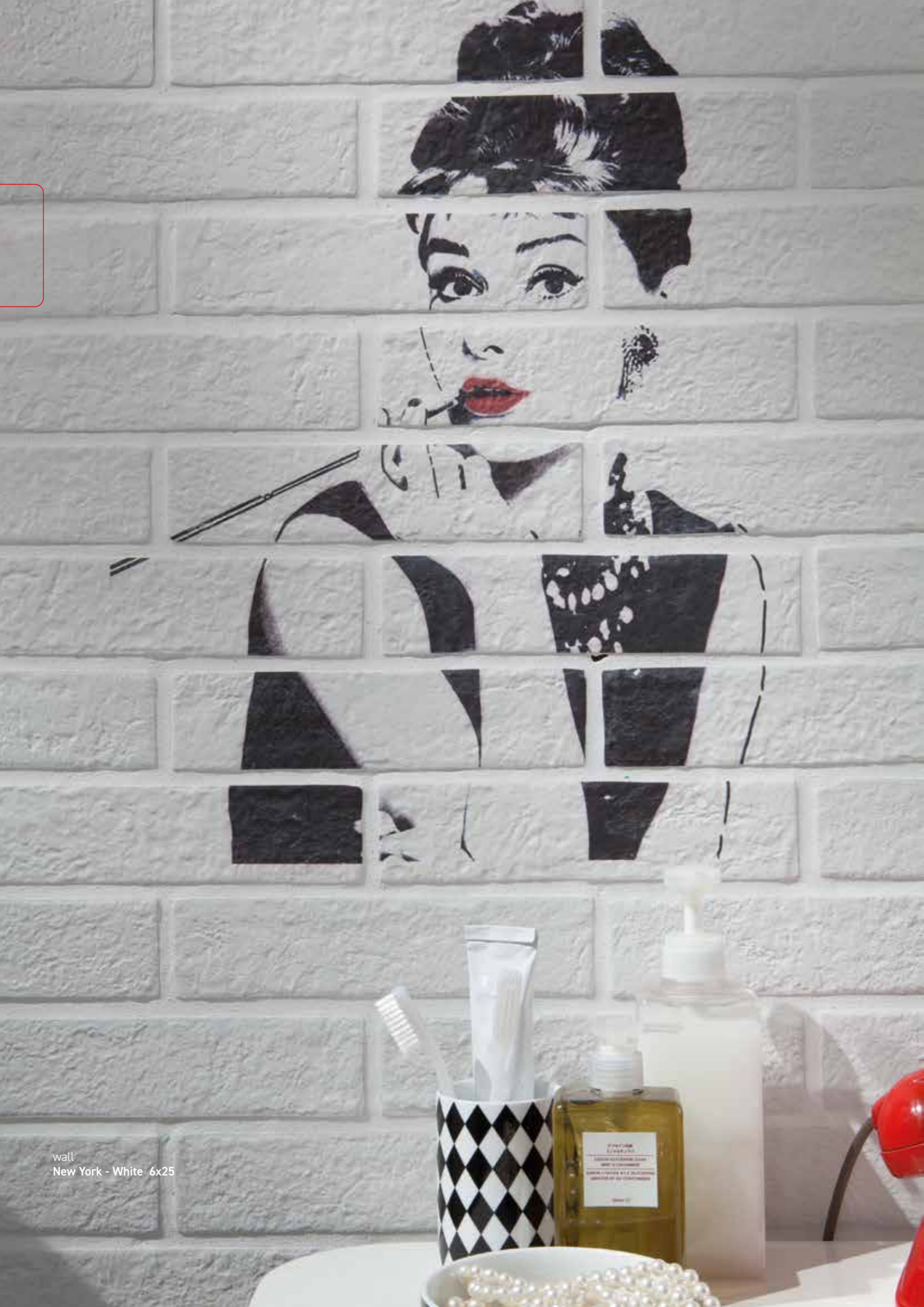

wall
New York - White 6x25

NEW YORK

[Back to Index](#)



BLACK



GREY

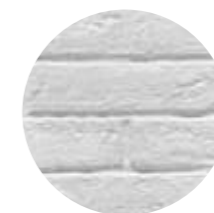

WHITE



ALMOND



BRICK
GRES GENERATION

GRES PORCELLANATO SMALTATO
GLAZED PORCELAIN STONEWARE
GRES CERAME EMAILLE
GLASIERTESFEINSTEINZEUG



6x25
2 1/3"x10"

IN OUT R11
c

white



J85677
6x25 (2 1/3"x10")

firma white



J85875
6x25 (2 1/3"x10")

image white (comp. 18 pz - set 18 pcs.)



J85876
6x25 (2 1/3"x10")

Abbinamenti suggeriti
Suggested matchings
Combinaison conseillée
Kombinationsvorschläge



IN OUT R11
c

good morning mix (6 soggetti - 6 design)



J86217
6x25 (2 1/3"x10")

Abbinamenti suggeriti
Suggested matchings
Combinaison conseillée
Kombinationsvorschläge

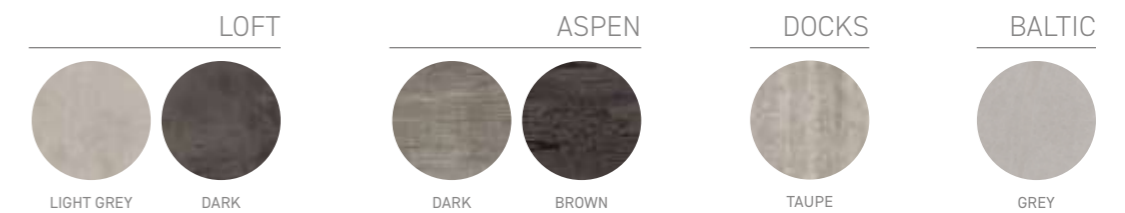

IN OUT R11
c

black



J85676
6x25 (2 1/3"x10")

firma black



J85873
6x25 (2 1/3"x10")

grey



J85860
6x25 (2 1/3"x10")

firma grey



J85874
6x25 (2 1/3"x10")

Abbinamenti suggeriti
Suggested matchings
Combinaison conseillée
Kombinationsvorschläge

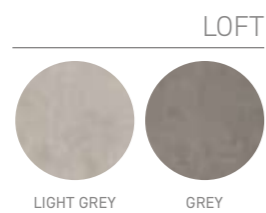

IN OUT R11
c

almond











J85675
6x25 (2 1/3"x10")

firma almond



J85872
6x25 (2 1/3"x10")

	 6x25 (2 1/3"x10")	 Firma 6x25 (2 1/3"x10")	 Good Morning Mix 6x25 (2 1/3"x10")	 Image White 6x25 (2 1/3"x10")	 Angolo Incollato 12x25x6 (4 3/4"x10"x2 1/2")
 BLACK	J85676	J85873	-	-	J85714
 GREY	J85860	J85874	-	-	J85861
 WHITE	J85677	J85875	J86217	J85876	J85715
 ALMOND	J85675	J85872	-	-	J85713
SPESSORE THICKNESS	9,5 mm	9,5 mm	9,5 mm	9,5 mm	9,5 mm
KG/M²	16,9	16,9	16,9	16,1	16,9
PZ/BOX	32	3	6	1 cp/set	12
M²/BOX	0,58 *	-	-	-	-
BOX/PALLET	100	-	-	-	-
M²/PALLET	58	-	-	-	-
KG/PALLET	980,2	-	-	-	-
€ <1 PALLET	64,90/m²	11,70 pz/pce	19,40 pz/pce	195,00 cp/set	15,00 pz/pce
€ >1 PALLET	56,40/m²	11,70 pz/pce	19,40 pz/pce	195,00 cp/set	15,00 pz/pce

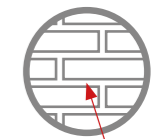

POSARE CON FUGA DI 1 CM
LAY WITH 1 CM JOINT
POSER AVEC UN JOINT DE 1 CM
MIT EINER 1 CM FUGE VERLEGEN

* Compresa fuga di 1 cm
1 cm joint included

Contributo spese imballo € 10,00/pal (netto). - Packing charges € 10,00/pal (net)

 0,3%
  A • HA • LA
  OK
  46 N/mm²
  6
  5
  Black 3 Classe III
  Grey, Almond 4 Classe IV
  White 5 Classe V
  Dcof: Wet 0,65 Pendulum: Dry 55 • Wet 48
 

SKYLINE

[Back to Index](#)

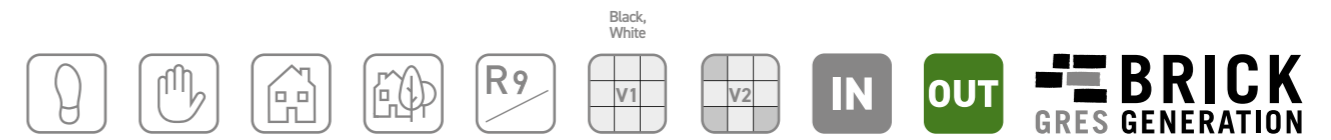

GRES PORCELLANATO SMALTATO
 GLAZED PORCELAIN STONEWARE
 GRES CERAME EMAILLE
 GLASIERTESFEINSTEINZEUG



6x25
 2 1/3"x10"



Skyline - 6x25

IN OUT R9

black



J88542
6x25 (2 1/3"x10")

dark grey



J88548
6x25 (2 1/3"x10")

grey



J88545
6x25 (2 1/3"x10")

light grey



J88797
6x25 (2 1/3"x10")

beige



J88541
6x25 (2 1/3"x10")

taupe



J88544
6x25 (2 1/3"x10")

white



J88550
6x25 (2 1/3"x10")

almond



J88798
6x25 (2 1/3"x10")

Abbinamenti suggeriti
Suggested matchings
Combinaison conseillée
Kombinationsvorschläge



IN OUT R9

Abbinamenti suggeriti
Suggested matchings
Combinaison conseillée
Kombinationsvorschläge

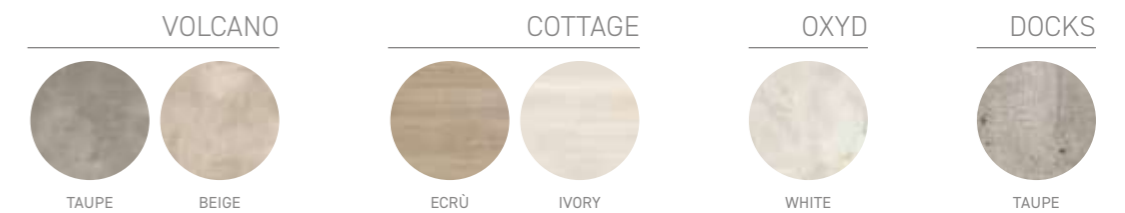

IN OUT R9

musk



J88549
6x25 (2 1/3"x10")

light blue



J88547
6x25 (2 1/3"x10")

copper



J88853
6x25 (2 1/3"x10")

bronze



J88543
6x25 (2 1/3"x10")

Abbinamenti suggeriti
Suggested matchings
Combinaison conseillée
Kombinationsvorschläge

DOCKS

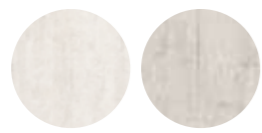

WHITE LIGHT GREY

TIMELESS

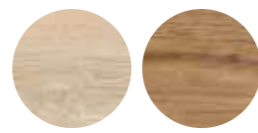

ECRÙ NUT

OXYD



CORTEN

RENAISSANCE



GREEN

	B-Slim 6x25 (2 1/3"x10")	Angolo Incollato 12x25x6 (4 3/4"x10"x2 1/3")	Quarter Round 0,5x25 (1/4"x10")
BLACK	J88542	J89252	J89560
DARK GREY	J88548	J89255	J89563
GREY	J88545	J89256	J89564
LIGHT GREY	J88797	J89258	J89566
WHITE	J88550	J89261	J89569
ALMOND	J88798	J89250	J89558
BEIGE	J88541	J89251	J89559
TAUPE	J88544	J89260	J89568
MUSK	J88549	J89259	J89567
LIGHT BLUE	J88547	J89257	J89565
COPPER	J88853	J89254	J89562
BRONZE	J88543	J89253	J89561
SPESSORE THICKNESS	6 mm	6 mm	-
KG/M²	12,44	16,90	-
PZ/BOX	52	24	6
M²/BOX	0,78	-	-
BOX/PALLET	100	-	-
M²/PALLET	78,00	-	-
KG/PALLET	970	-	-
€ <1 PALLET	64,90/m² - 68,70/m² *	15,00 pz/pce	10,90 pz/pce - 15,10 pz/pce *
€ >1 PALLET	56,40/m² - 59,70/m² *	15,00 pz/pce	10,90 pz/pce - 15,10 pz/pce *

Contributo spese imballo € 10,00/pal (netto). - Packing charges € 10,00/pal (net)

* Prezzo Bronze e Copper
Bronze and Copper price

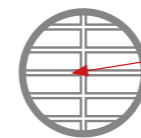

POSARE CON FUGA DI 3 MM
LAY WITH 3 MM JOINT
POSER AVEC UN JOINT DE 3 MM
MIT EINER 3 MM FUGE VERLEGEN

0,20% A · HA · LA OK >55 N/mm² 6 5 Classe III Classe IV Classe V Dcof: Wet 0,48 Pendulum: Dry 48 · Wet 28

Taupe, Grey, Black, Bronze, Copper, Iron, Light Grey, Dark Grey, Light Blue, Musk, Almond, Beige, White, Black, White



Soho - Noho

[Back to Index](#)

SOHO

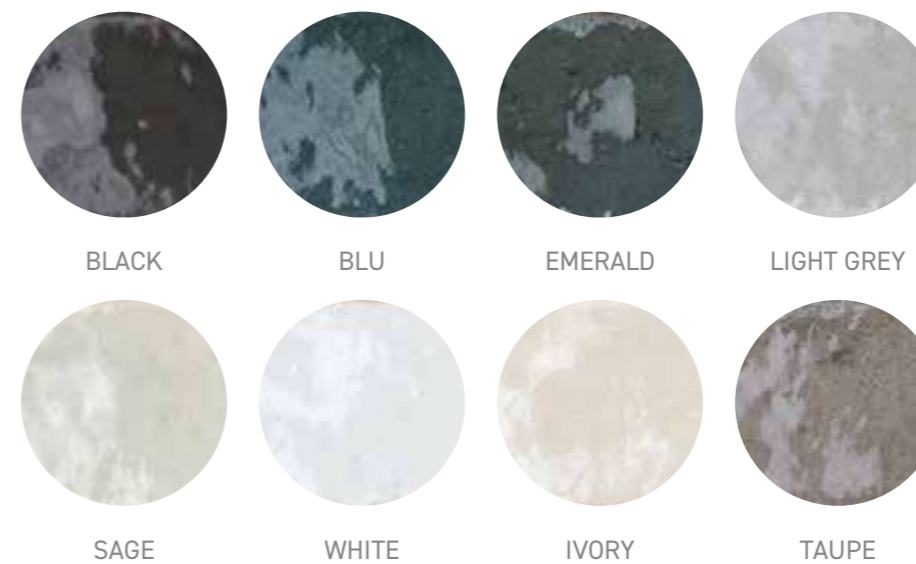

NOHO

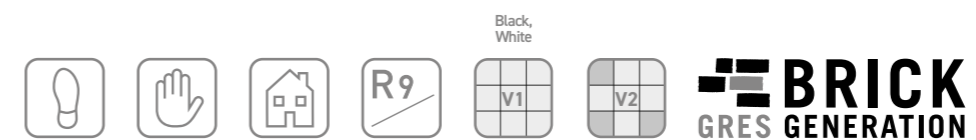
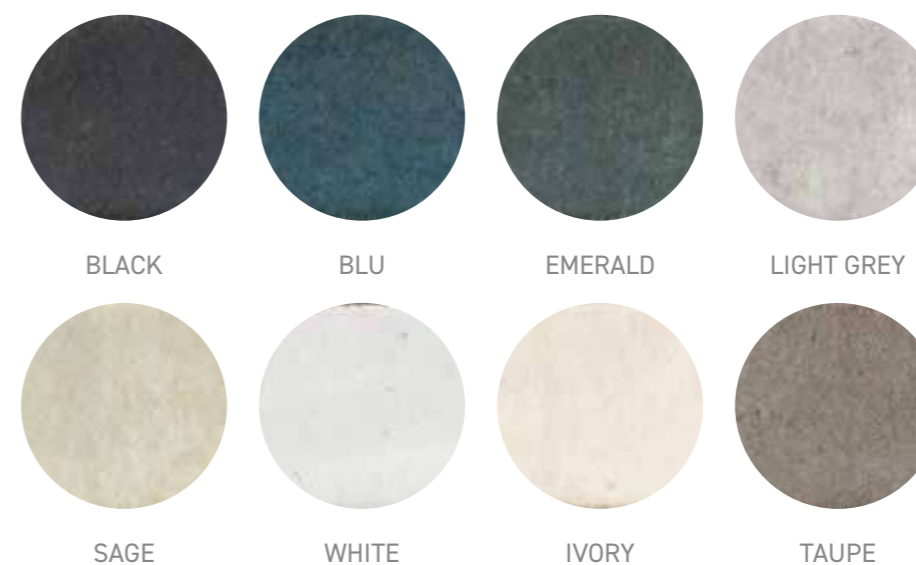

GRES PORCELLANATO SMALTATO
 GLAZED PORCELAIN STONEWARE
 GRES CERAME EMAILLE
 GLASIERTESFEINSTEINZEUG

9,5 mm



6x25
 2 1/3"x10"

Coordinato con:
 Coordinated with:
MANHATTAN
 SEZ. LE MATERIE
 PG. 563



wall
Soho - Emerald 6x25
Noho - Emerald 6x25
Loft - Jungle Hot 40x80

floor
Timeless - Honey 24x150



black

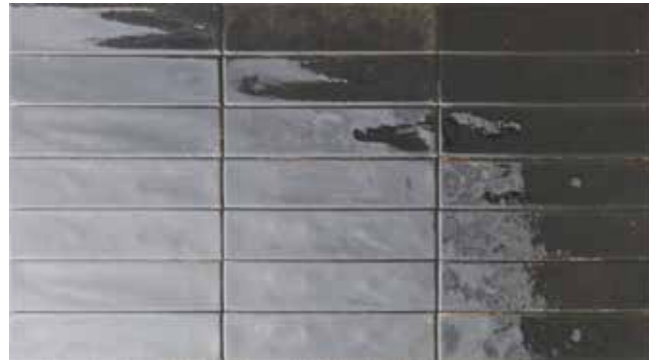

J89521
6x25 (2 1/3"x10")

blu



J89522
6x25 (2 1/3"x10")

emerald



J89523
6x25 (2 1/3"x10")

light grey



J89525
6x25 (2 1/3"x10")

sage



J89526
6x25 (2 1/3"x10")

white



J89528
6x25 (2 1/3"x10")

ivory



J89524
6x25 (2 1/3"x10")

taupe



J89527
6x25 (2 1/3"x10")



Abbinamenti suggeriti
Suggested matchings
Combinaison conseillée
Kombinationsvorschläge

MANHATTAN



BLU LIGHT GREY WHITE IVORY COTTO TAUPE

Abbinamenti suggeriti
Suggested matchings
Combinaison conseillée
Kombinationsvorschläge

MANHATTAN



BLU LIGHT GREY WHITE IVORY COTTO TAUPE



black



J89529
6x25 (2 1/3"x10")

blu



J89530
6x25 (2 1/3"x10")

emerald



J89531
6x25 (2 1/3"x10")

light grey



J89533
6x25 (2 1/3"x10")

sage



J89534
6x25 (2 1/3"x10")

white



J89536
6x25 (2 1/3"x10")

ivory



J89532
6x25 (2 1/3"x10")

taupe



J89535
6x25 (2 1/3"x10")

Abbinamenti suggeriti
Suggested matchings
Combinaison conseillée
Kombinationsvorschläge

MANHATTAN

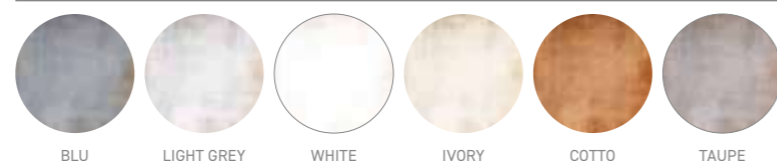

BLU LIGHT GREY WHITE IVORY COTTO TAUPE



Abbinamenti suggeriti
Suggested matchings
Combinaison conseillée
Kombinationsvorschläge

MANHATTAN

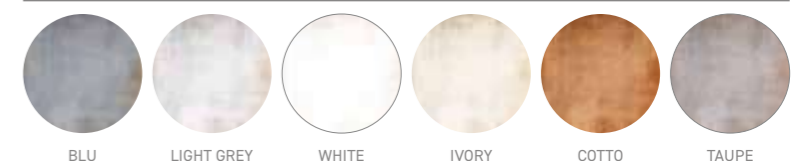

BLU LIGHT GREY WHITE IVORY COTTO TAUPE

blu sviluppo grafico 6x25 (2 1/3"x10")



120 6x25

GRAFICHE DIVERSE
DIFFERENT PATTERNS
DIFFÉRENTS MOTIFS
VERSCHIEDENE MUSTER

	SOHO 6x25 (2 1/3"x10")	Angolo Incollato 12x25x6 (4 1/2"x10"x2 1/3")	Quarter Round 0,5x25 (1/8"x10")
BLACK	J89521	J90146	J89718
BLU	J89522	J90147	J89719
EMERALD	J89523	J90148	J89720
LIGHT GREY	J89525	J90150	J89722
SAGE	J89526	J90151	J89723
WHITE	J89528	J90153	J89725
IVORY	J89524	J90149	J89721
TAUPE	J89527	J90152	J89724
SPessore THICKNESS	9,5 mm	9,5 mm	-
KG/M²	20,41	-	-
PZ/BOX	32	12	6
M²/BOX	0,48	-	-
BOX/PALLET	100	-	-
M²/PALLET	48	-	-
KG/PALLET	980	-	-
€ <1 PALLET	71,90 / m²	15,00 pz / pce	9,30 pz / pce
€ >1 PALLET	62,50 / m²	15,00 pz / pce	9,30 pz / pce

	NOHO 6x25 (2 1/3"x10")	Angolo Incollato 12x25x6 (4 1/2"x10"x2 1/3")	Quarter Round 0,5x25 (1/8"x10")
BLACK	J89529	J90156	J89726
BLU	J89530	J90157	J89727
EMERALD	J89531	J90158	J89728
LIGHT GREY	J89533	J90160	J89730
SAGE	J89534	J90161	J89731
WHITE	J89536	J90163	J89733
IVORY	J89532	J90159	J89729
TAUPE	J89535	J90162	J89732
SPessore THICKNESS	9,5 mm	9,5 mm	-
KG/M²	20,41	-	-
PZ/BOX	32	12	6
M²/BOX	0,48	-	-
BOX/PALLET	100	-	-
M²/PALLET	48	-	-
KG/PALLET	980	-	-
€ <1 PALLET	71,90 / m²	15,00 pz / pce	9,30 pz / pce
€ >1 PALLET	62,50 / m²	15,00 pz / pce	9,30 pz / pce

Contributo spese imballo € 10,00/pal (netto). - Packing charges € 10,00/pal (net)

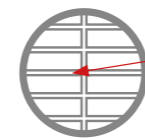

POSARE CON FUGA DI 3 MM
LAY WITH 3 MM JOINT
POSER AVEC UN JOINT DE 3 MM
MIT EINER 3 MM FUGE VERLEGEN

< 0,2%
 A • HA • LA
 OK
 > 40 N/mm²
 5
 5
 Classe III
 Classe IV
 Classe V
 R9
 V1
 V2

Black, Blu, Emerald
 Taupe
 Ivory, Light Grey, Sage, White
 Black, White

Dcof: > 0,42
 Pendulum:
 Dry > 36; Wet 25 < x < 35



Solid - 6,1x37

[Back to Index](#)

SOLID

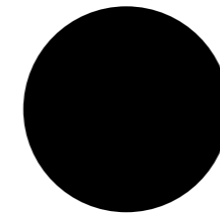

NOTTE

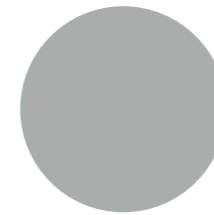

GRIGIO



CENERE



BIANCO



BIANCO MATT



AVORIO

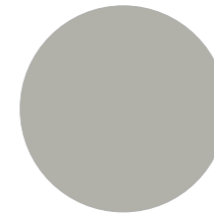

GREIGE

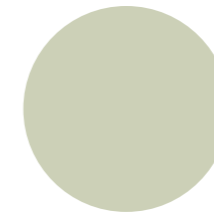

MENTA

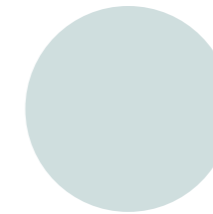

ACQUA



BRICK
GRES GENERATION

GRES PORCELLANATO SMALTATO
GLAZED PORCELAIN STONEWARE
GRES CERAME EMAILLE
GLASIERTESFEINSTEINZEUG

Bslim 
high tech ceramics

6,1x37
2 2/5" x 1 1/2"



notte



J88399
6,1x37 (2 2/5"x14 1/2")

grigio



J88366
6,1x37 (2 2/5"x14 1/2")

avorio

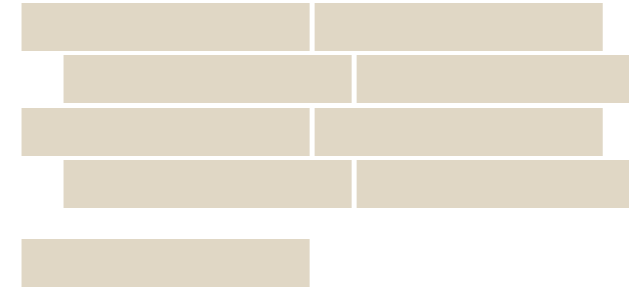

J88363
6,1x37 (2 2/5"x14 1/2")

greige



J88365
6,1x37 (2 2/5"x14 1/2")

cenere

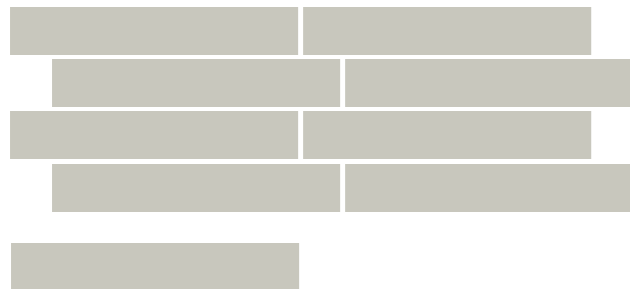

J88364
6,1x37 (2 2/5"x14 1/2")

bianco

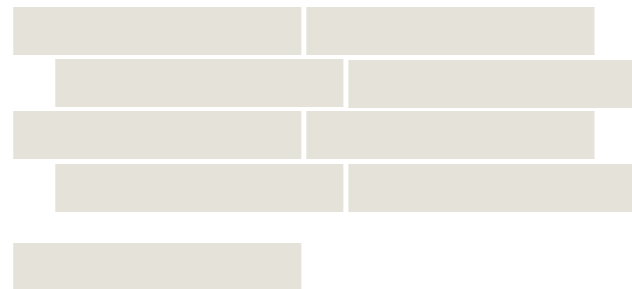

J88667
6,1x37 (2 2/5"x14 1/2")

bianco matt

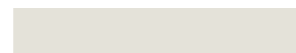

J88367
6,1x37 (2 2/5"x14 1/2")

menta



J88368
6,1x37 (2 2/5"x14 1/2")

acqua

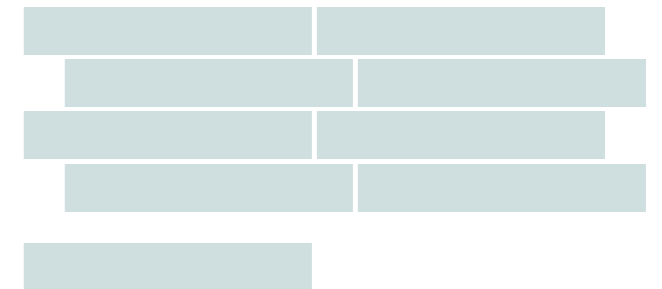

J88362
6,1x37 (2 2/5"x14 1/2")

Abbinamenti suggeriti
Suggested matchings
Combinaison conseillée
Kombinationsvorschläge

VOLCANO

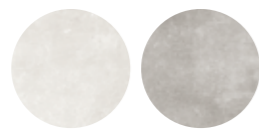

WHITE GREY

COTTAGE

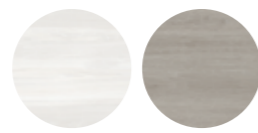

ICE MUD

OXYD

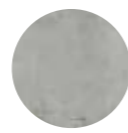

LIGHT GREY

BALTIC



DARK GREY

Abbinamenti suggeriti
Suggested matchings
Combinaison conseillée
Kombinationsvorschläge

VOLCANO

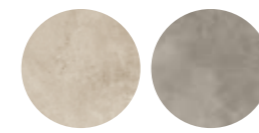

BEIGE TAUPE

COTTAGE

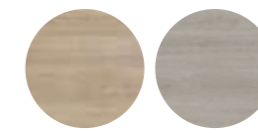

ECRÙ MUD

OXYD



WHITE

DOCKS



WHITE



wall
Solid - Menta 6,1x37

	B-Slim 6,1x37 (2 2/5"x14 1/2")	Quarter Round 0,6x37 (1/3"x14 1/2")
● NOTTE	J88399	J88665
● GRIGIO	J88366	J88662
● CENERE	J88364	J88660
● BIANCO	J88667	J88666
● BIANCO MATT	J88367	J88663
● AVORIO	J88363	J88659
● GREIGE	J88365	J88661
● MENTA	J88368	J88664
● ACQUA	J88362	J88658
SPESSORE THICKNESS	6 mm	6 mm
KG/M²	12,28	-
PZ/BOX	62	12
M²/BOX	1,40	-
BOX/PALLET	60	-
M²/PALLET	84,00	-
KG/PALLET	1032	-
€ <1 PALLET	55,70/m²	11,70 pz/pce
€ ≥1 PALLET	46,40/m²	11,70 pz/pce

Contributo spese imballo € 10,00/pal (netto). - Packing charges € 10,00/pal (net)

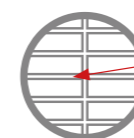

POSARE CON FUGA DI 3 MM
LAY WITH 3 MM JOINT
POSER AVEC UN JOINT DE 3 MM
MIT EINER 3 MM FUGE VERLEGEN



0,15%



A • HA • LA



OK



51,7N/mm²



6



5



Classe III



Classe IV



Classe V



Dcof: Wet 0,48
Pendulum:
Dry 50 • Wet 28



V1



The Wall - 6x25

[Back to Index](#)

THE WALL



DARK GREY WHITE FOG RED OLD RED

GRES PORCELLANATO SMALTATO
 GLAZED PORCELAIN STONEWARE
 GRES CERAME EMAILLE
 GLASIERTESFEINSTEINZEUG

6x25
2 1/3"x10"

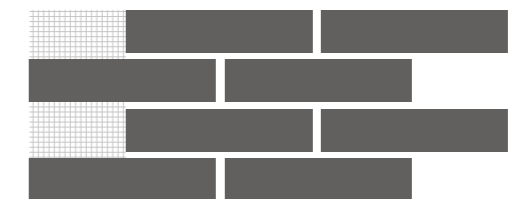

51,6x27,2
20"x11"

IN OUT R11
C

dark



J88791
51,6x27,2 (20"x11")



J88456
6x25 (2 1/3"x10")

grey



J88793
51,6x27,2 (20"x11")



J88458
6x25 (2 1/3"x10")

Abbinamenti suggeriti
Suggested matchings
Combinaison conseillée
Kombinationsvorschläge

VOLCANO

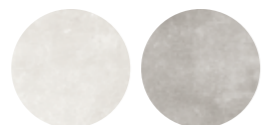

WHITE

GREY

GREENWOOD



BIANCO

NERO

BALTIC



GREY

OXYD



WHITE

IN OUT R11
C

white



J88796
51,6x27,2 (20"x11")



J88461
6x25 (2 1/3"x10")



fog



J88792
51,6x27,2 (20"x11")



J88457
6x25 (2 1/3"x10")

Abbinamenti suggeriti
Suggested matchings
Combinaison conseillée
Kombinationsvorschläge

LOFT



GREY

TAUPE

COTTAGE



ICE

MUD

OXYD



LIGHT GREY

PROVENCE



GREY

IN OUT R11 C

red



J88795
51,6x27,2 (20"x11")



J88460
6x25 (2 1/8"x10")

old red



J88794
51,6x27,2 (20"x11")



J88459
6x25 (2 1/8"x10")

Abbinamenti suggeriti
Suggested matchings
Combinaison conseillée
Kombinationsvorschläge

VOLCANO

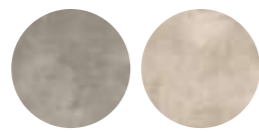

TAUPE BEIGE

DARING



HONEY NUT

OXYD



CORTEN

TUSCANY



SAN MINIATO

red sviluppo grafico 6x25 (2 1/8"x10")



100 6x25

GRAFICHE DIVERSE
DIFFERENT PATTERNS
DIFFÉRENTS MOTIFS
VERSCHIEDENE MUSTER

	B-Slim 6x25 (2 1/8"x10")	B-Slim 51,6x27,2 (20"x11")	Angolo Incollato 12x25x6 (4 3/8"x10"x2 1/8")
DARK	J88456	J88791	J89397
GREY	J88458	J88793	J89399
WHITE	J88461	J88796	J89402
FOG	J88457	J88792	J89398
RED	J88460	J88795	J89401
OLD RED	J88459	J88794	J89400
SPESSORE THICKNESS	6 mm	6 mm	6 mm
KG/M²	10,44	10,85	-
PZ/BOX	50	10	12
M²/BOX	0,91 *	1,4	-
BOX/PALLET	100	32	-
M²/PALLET	91,00	44,80	-
KG/PALLET	950	486,4	-
€ <1 PALLET	64,90/m²	72,50/m²	15,00 pz/pce
€ >1 PALLET	56,40/m²	63,00/m²	15,00 pz/pce

POSARE CON FUGA DI 0,8 CM
LAY WITH 0,8 CM JOINT
POSER AVEC UN JOINT DE 0,8 CM
MIT EINER 0,8 CM FUGE VERLEGEN

* Compresa fuga di 0,8 cm
0,8 cm joint included

Contributo spese imballo € 10,00/pal (netto). - Packing charges € 10,00/pal (net)

0,20% A · HA · LA OK > 50 N/mm² 7 5 Dark 3 Classe III Grey, Old Red 4 Classe IV Fog, Red, White 5 Classe V R11 C White V1 V4

Dcof: Wet 0,65 Pendulum: Dry 55 · Wet 48



wall
Tribeca - White 6x25

[Back to Index](#)

TRIBECA



GREY

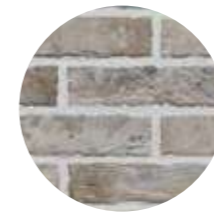

MUD



WHITE



SAND



MULTICOLOR



OLD RED



GRES PORCELLANATO SMALTATO
GLAZED PORCELAIN STONEWARE
GRES CERAME EMAILLE
GLASIERTESFEINSTEINZEUG



6x25
2 1/8"x10"

IN OUT R11
C

grey



J85883
6x25 (2 1/3"x10")

firma grey



J86003
6x25 (2 1/3"x10")

mud



J85884
6x25 (2 1/3"x10")

firma mud



J86004
6x25 (2 1/3"x10")

Abbinamenti suggeriti
Suggested matchings
Combinaison conseillée
Kombinationsvorschläge

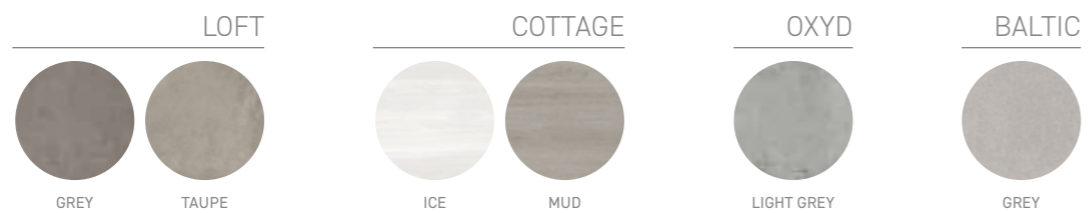

IN OUT R11
C

white



J85888
6x25 (2 1/3"x10")

firma white



J86008
6x25 (2 1/3"x10")



marylin white (comp. 18 pz - set 18 pcs.)



J86206
6x25 (2 1/3"x10")

white breakfast mix



J86024
6x25 (2 1/3"x10")

Abbinamenti suggeriti
Suggested matchings
Combinaison conseillée
Kombinationsvorschläge



IN OUT R11
C

sand



J85887
6x25 (2 1/3"x10")

firma sand



J86007
6x25 (2 1/3"x10")

multicolor



J85885
6x25 (2 1/3"x10")

firma multicolor



J86005
6x25 (2 1/3"x10")

Abbinamenti suggeriti
Suggested matchings
Combinaison conseillée
Kombinationsvorschläge



IN OUT R11
C

old red

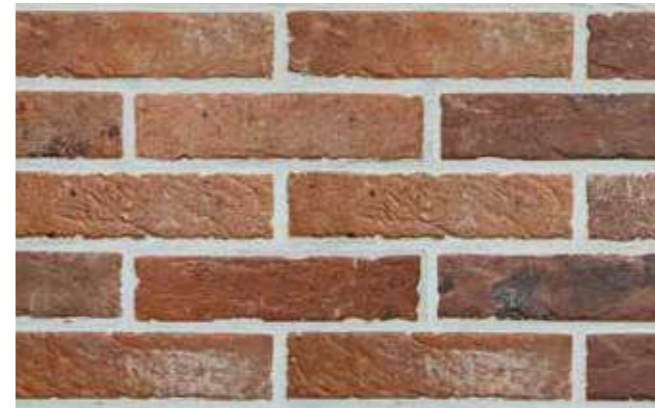

J85886
6x25 (2 1/3"x10")

firma old red



J86006
6x25 (2 1/3"x10")



wall
Tribeca - Old Red 6x25

Abbinamenti suggeriti
Suggested matchings
Combinaison conseillée
Kombinationsvorschläge



sand sviluppo grafico 6x25 (2 1/3"x10")



62 6x25

GRAFICHE DIVERSE

DIFFERENT PATTERNS
DIFFÉRENTS MOTIFS
VERSCHIEDENE MUSTER



wall
Tribece - Sand 6x25

						
	6x25 (2 1/3"x10")	Firma 6x25 (2 1/3"x10")	Breakfast Mix 6x25 (2 1/3"x10")	Marilyn 6x25 (2 1/3"x10")	Angolo Incollato 12x25x6 (4 3/4"x10"x2 1/3")	Angolo monolitico 4x17x6 (1 3/4"x7"x2 1/3")
 GREY	J85883	J86003	-	-	J85889	J85968
 MUD	J85884	J86004	-	-	J85890	J85969
 WHITE	J85888	J86008	J86024	J86206	J85894	J85973
 SAND	J85887	J86007	-	-	J85893	J85972
 MULTICOLOR	J85885	J86005	-	-	J85891	J85970
 OLD RED	J85886	J86006	-	-	J85892	J85971
SPESSORE THICKNESS	9,5 mm	9,5 mm	9,5 mm	9,5 mm	9,5 mm	9,5 mm
KG/M²	16,9	16,9	16,9	16,9	16,9	16,9
PZ/BOX	32	3	6	1 cp/set	12	10
M²/BOX	0,58 *	-	-	-	-	-
BOX/PALLET	100	-	-	-	-	-
M²/PALLET	58	-	-	-	-	-
KG/PALLET	980,2	-	-	-	-	-
€ <1 PALLET	64,90/m²	11,70 pz/pce	19,40 pz/pce	195,00 cp/set	15,00 pz/pce	9,70 pz/pce
€ >1 PALLET	56,40/m²	11,70 pz/pce	19,40 pz/pce	195,00 cp/set	15,00 pz/pce	9,70 pz/pce

Contributo spese imballo € 10,00/pal (netto). - Packing charges € 10,00/pal (net)

* Compresa fuga di 1 cm - 1 cm joint included



POSARE CON FUGA DI 1 CM
LAY WITH 1 CM JOINT
POSER AVEC UN JOINT DE 1 CM
MIT EINER 1 CM FUGE VERLEGEN



0,3%



A • HA • LA



OK



46,35 N/mm²



6



5



Classe V



Dcof: Wet 0,65
Pendulum:
Dry 55 • Wet 48



White



V4



URBAN&COLORS

[Back to Index](#)



BALTIC T.U.



BALENE T.U.



BRACCO T.U.



BIANCO T.U.



BALTIC SHADE



BALENE SHADE



BRACCO SHADE



T.U.



Shade



GRES PORCELLANATO SMALTATO
 GLAZED PORCELAIN STONWARE
 GRES CERAME EMAILLE
 GLASIERTESFEINSTEINZEUG

DESIGN BY

Andrea Castignano



6x25
 2 1/3"x10"

wall
 Urban&Color - Balene T.U. 6x25
 Urban&Color - Bianco T.U. 6x25

floor
 Ever - Oak 20x120

IN OUT R10
B

baltic t.u.



J86572
6x25 (2 1/3"x10")

baltic shade



J86571
6x25 (2 1/3"x10")

baltic tracks

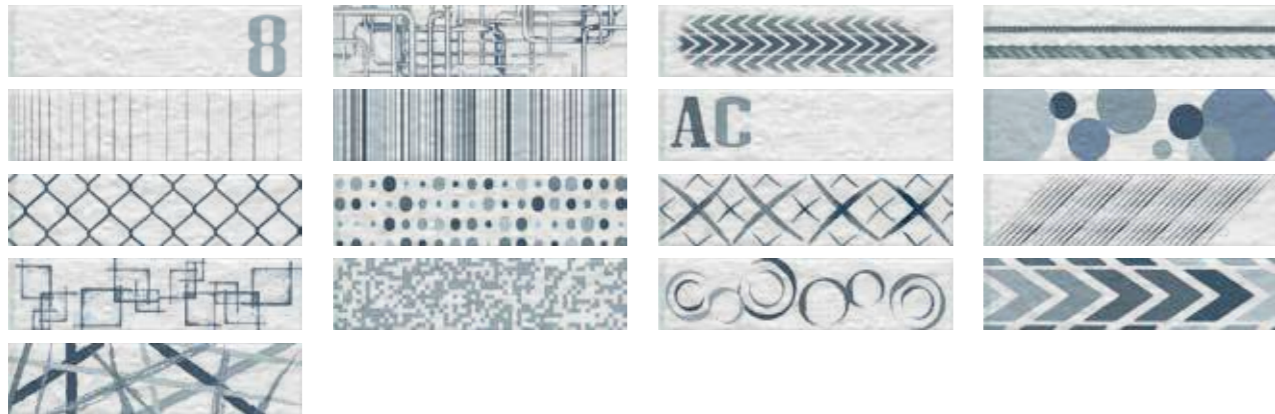

J86614
6x25 (2 1/3"x10")

Abbinamenti suggeriti
Suggested matchings
Combinaison conseillée
Kombinationsvorschläge

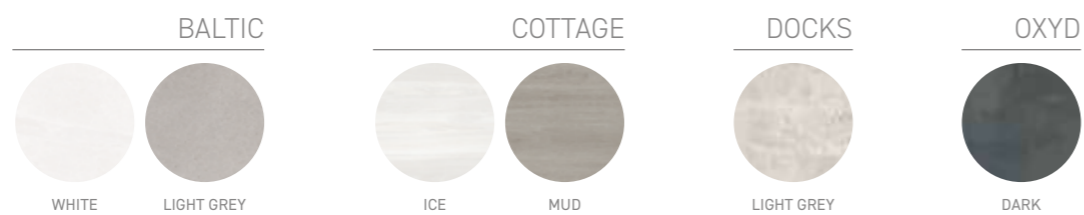

IN OUT R10
B

balene t.u.



J86570
6x25 (2 1/3"x10")

balene shade



J86569
6x25 (2 1/3"x10")

balene tracks



J86613
6x25 (2 1/3"x10")

Abbinamenti suggeriti
Suggested matchings
Combinaison conseillée
Kombinationsvorschläge



IN OUT R10
B

bracco t.u.



J86568
6x25 (2 1/3"x10")

bracco shade



J86567
6x25 (2 1/3"x10")

bianco t.u.



J86573
6x25 (2 1/3"x10")

bracco tracks

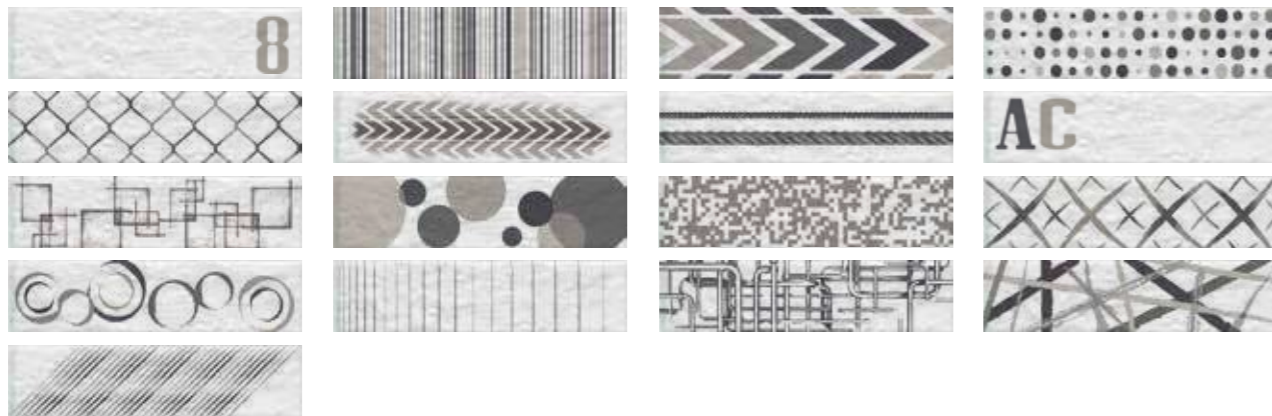

J86612
6x25 (2 1/3"x10")

Abbinamenti suggeriti
Suggested matchings
Combinaison conseillée
Kombinationsvorschläge

PROVENCE



LIGHT GREY TAUPE

DARING



HONEY NUT

BALTIC



WHITE

OXYD



WHITE

IN OUT R10
B

Abbinamenti suggeriti
Suggested matchings
Combinaison conseillée
Kombinationsvorschläge

VOLCANO

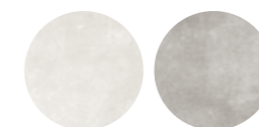

WHITE GREY

GREENWOOD



BIANCO BEIGE

DOCKS



LIGHT GREY











OXYD



WHITE



wall
Urban&Color - Bracco Shade 6x25
floor
Woodie - White 24x120

			
	6x25 (2 1/3"x10")	Tracks 6x25 (2 1/3"x10")	Angolo Incollato 12x25x6 (4 3/4"x10"x2 1/3")
 BALTIC T.U.	J86572	J86614	J86825
 BALTIC SHADE	J86571	-	J86824
 BALENE T.U.	J86570	J86613	J86823
 BALENE SHADE	J86569	-	J86822
 BRACCO T.U.	J86568	J86612	J86821
 BRACCO SHADE	J86567	-	J86820
 BIANCO T.U.	J86573	-	J86826
SPESSORE THICKNESS	9 mm	9 mm	9 mm
KG/M²	16,96	16,96	16,9
PZ/BOX	34	34	12
M²/BOX	0,56 *	0,56	-
BOX/PALLET	99	99	-
M²/PALLET	55,44	55,44	-
KG/PALLET	940,3	940,3	-
€ <1 PALLET	76,40/m²	91,00/m²	15,00 pz/pce
€ >1 PALLET	66,40/m²	91,00/m²	15,00 pz/pce

Contributo spese imballo € 10,00/pal (netto). - Packing charges € 10,00/pal (net)

* Compresa fuga di 1 cm - 1 cm joint included

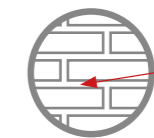

POSARE CON FUGA DI 1 CM
LAY WITH 1 CM JOINT
POSER AVEC UN JOINT DE 1 CM
MIT EINER 1 CM FUGE VERLEGEN



0,28%



A • HA • LA



OK



55,1 N/mm²



5



5



Classe IV



Dcof: Wet 0,64
Pendulum:
Dry 51 • Wet 41

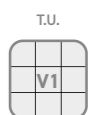

T.U.



Shade

“ Il rivestimento 3D riporta sul gres porcellanato cubi di pietra o assi di legno su più livelli, capaci di creare diverse impressioni di profondità e ritmare le pareti con un piacevole effetto tridimensionale. Frutto della sofisticata tecnologia “tile detector”, che permette di fotografare e comunicare alla macchina digitale l’esatta scansione grafica che si desidera riprodurre, il rivestimento 3D vanta una sorprendente fedeltà mimetica e una resa materica tattile e d’impatto. Suggestiva per la zona living, originale per gli ambienti bagno e il giusto mix tra ricercatezza e innovazione per spazi pubblici quali spa o esercizi commerciali: il rivestimento 3D si adatta in modo versatile ad ogni stile, necessità e destinazione d’uso anche in esterno, grazie alle caratteristiche tecniche superiori del gres porcellanato.

”

The 3D wall covering features different levels of stone cubes or wooden planks on porcelain stoneware, creating different impressions of depth and re-create the walls with a pleasant three-dimensional effect. The result of the sophisticated “tile detector” technology, which allows photographing and communicating the exact graphic scan to be reproduced to the digital printer, the 3D wall covering boasts an amazing camouflage fidelity and a tactile and impact material yield. Suggestive for the living area, original for the bathroom and the right mix of sophistication and innovation for public spaces such as spas or shops: the 3D wall covering adapts in a versatile way to any style, need and intended use even outdoors, thanks to the superior technical characteristics of porcelain stoneware.

Le revêtement de mur 3D comporte différents niveaux de cubes de pierre ou de planches de bois sur le grès de porcelaine, créant différentes impressions de profondeur et recréant les murs avec un effet tridimensionnel agréable. Le résultat de la technologie sophistiquée de «détecteur de carreaux», qui permet de photographier et de communiquer le scan graphique exact à reproduire à l’imprimante numérique, le revêtement mural 3D offre une incroyable fidélité de camouflage et un rendement tactile et matériel. Suggestif pour le salon, original pour la salle de bain et le bon mélange de sophistication et d’innovation pour les espaces publics tels que les spas ou les magasins: le revêtement mural 3D s’adapte de manière polyvalente à tout style, besoin et utilisation, même à l’extérieur, grâce aux caractéristiques techniques supérieures du grès cérame.

Die 3D-Wandverkleidung weist auf das Feinsteinzeug verschiedene Ebenen von Steinwürfeln oder Holzbretter, die unterschiedliche Tiefeneindrücke erzeugen auf und die Wände mit einem angenehmen dreidimensionalen Effekt nachbilden. Das Ergebnis der hochentwickelten “tile-dektor” -Technologie, die es ermöglicht, den genauen grafischen Scan auf dem digitalen Drucker zu reproduzieren, zeichnet sich durch eine erstaunliche Tarnungstreue und einen taktilen und schlagzähen Materialertrag aus. Suggestiv für den Wohnbereich, originell für das Badezimmer und die richtige Mischung aus Raffinesse und Innovation für öffentliche Bereiche wie Wellness oder Shops: die 3D – Verblender passen sich dank der hervorragenden technische Eigenschaften von Feinsteinzeug jedem Stil, Bedarf und Verwendungszweck auch im Freien an.

Asiago	93	Palissandro 3D	131
Cubics	99	Quarzi 3D	137
Gioia	105	Tiffany	143
Inwood 3D	111	Timeless 3D	149
Loft 3D	117	Volcano 3D	157
Lyon	125	Wall Art	163

ASIAGO

[Back to Index](#)

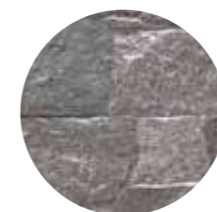

GRAFITE



GRIGIO



MULTICOLOR



BEIGE



GRES PORCELLANATO SMALTATO
GLAZED PORCELAIN STONEWARE
GRES CERAME EMAILLE
GLASIERTESFEINSTEINZEUG

Coordinato con:
Coordinated with:

LE CAVE
SEZ. PIETRE E MARMI
PG. 381

VALERIA
SEZ. PIETRE E MARMI
PG. 449



7-11 mm

15x61 DA PRESSA
6"x24" MOULDED



15x61
6"x24"



wall
Asiago - Multicolor 15x61

IN OUT

grafite



J88557
15x61 (6"x24")



J88639
Angolo Interno
20x10x15 (8"x4"x6")



J88635
Angolo Esterno
20x10x15 (8"x4"x6")

grigio



J88558
15x61 (6"x24")



J88640
Angolo Interno
20x10x15 (8"x4"x6")



J88636
Angolo Esterno
20x10x15 (8"x4"x6")

Abbinamenti suggeriti
Suggested matchings
Combinaison conseille
Kombinationsvorschläge

PROVENCE

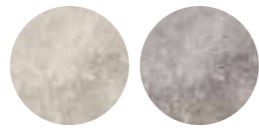

LIGHT GREY

GREY

DARING

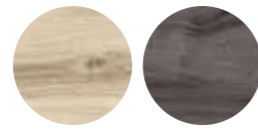

ECRÙ

DARK

LE CAVE

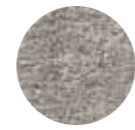

LUSERNA MULTICOLOR

LE CAVE

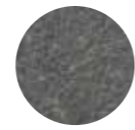

GRANITO GRAFITE

IN OUT

beige



J88556
15x61 (6"x24")



J88638
Angolo Interno
20x10x15 (8"x4"x6")



J88634
Angolo Esterno
20x10x15 (8"x4"x6")

multicolor



J88559
15x61 (6"x24")



J88641
Angolo Interno
20x10x15 (8"x4"x6")



J88637
Angolo Esterno
20x10x15 (8"x4"x6")

Abbinamenti suggeriti
Suggested matchings
Combinaison conseille
Kombinationsvorschläge

DOCKS

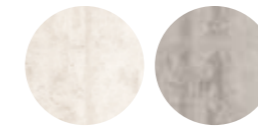

BEIGE

TAUPE

TIMELESS

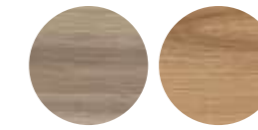

GREIGE

NUT

LE CAVE



BARGE BEIGE

LE CAVE

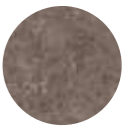

PROFIDO BRUNO

multicolor sviluppo grafico 15x61 (6"x24")



215 15x61

GRAFICHE DIVERSE

DIFFERENT PATTERNS
DIFFÉRENTS MOTIFS
VERSCHIEDENE MUSTER



wall
Asiago - Beige 15x61

	15x61 (6"x24")	Angolo Interno 20x10x15 (8"x4"x6")	Angolo Esterno 20x10x15 (8"x4"x6")
GRAFITE	J88557	J88639	J88635
GRIGIO	J88558	J88640	J88636
BEIGE	J88556	J88638	J88634
MULTICOLOR	J88559	J88641	J88637
SPESSORE THICKNESS	7-11 mm	7-11 mm	7-11 mm
KG/M²	19,61	-	-
PZ/BOX	11	6	6
M²/BOX	1,02	-	-
BOX/PALLET	48	-	-
M²/PALLET	48,96	-	-
KG/PALLET	960,48	-	-
€ <1 PALLET	47,40/m²	20,00 pz/pce	17,90 pz/pce
€ >1 PALLET	39,50/m²	20,00 pz/pce	17,90 pz/pce

Contributo spese imballo € 10,00/pal (netto). - Packing charges € 10,00/pal (net)



0,10%



A • HA • LA



OK



> 55 N/mm²



7



5

Grafite,
Multicolor



Classe IV

Beige,
Grigio



Classe V



CUBICS

[Back to Index](#)



MULTICOLOR

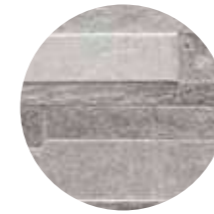

GREY



WHITE



BEIGE



GRES PORCELLANATO SMALTATO
GLAZED PORCELAIN STONEWARE
GRES CERAME EMAILLE
GLASIERTESFEINSTEINZEUG

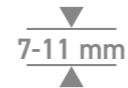

15x61 DA PRESSA
6"x24" MOULDED



15x61
6"x24"



wall
Cubics - Beige 15x61

IN OUT

multicolor



J86621
15x61 (6"x24")



J87225
Angolo Interno
20x10x15 (8"x4"x6")



J87229
Angolo Esterno
20x10x15 (8"x4"x6")

grey



J86619
15x61 (6"x24")



J87224
Angolo Interno
20x10x15 (8"x4"x6")



J87228
Angolo Esterno
20x10x15 (8"x4"x6")

Abbinamenti suggeriti
Suggested matchings
Combinaison conseille
Kombinationsvorschläge

PROVENCE

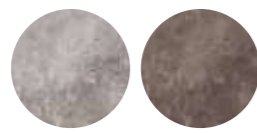

GREY MULTICOLOR

ASPEN

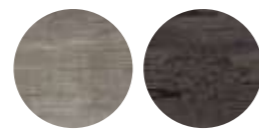

DARK BROWN

BALTIC



GREY

BALTIC

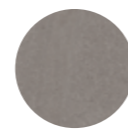

DARK GREY

IN OUT

white



J86620
15x61 (6"x24")



J87226
Angolo Interno
20x10x15 (8"x4"x6")



J87230
Angolo Esterno
20x10x15 (8"x4"x6")

beige



J86618
15x61 (6"x24")



J87223
Angolo Interno
20x10x15 (8"x4"x6")



J87227
Angolo Esterno
20x10x15 (8"x4"x6")

Abbinamenti suggeriti
Suggested matchings
Combinaison conseille
Kombinationsvorschläge

LOFT

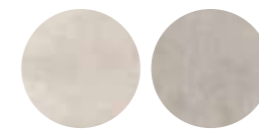

BEIGE LIGHT GREY

TIMELESS



IVORY GREIGE

DOCKS



WHITE

DOCKS



TAUPE

CUBICS

multicolor sviluppo grafico 15x61 (6"x24")



215 15x61

GRAFICHE DIVERSE

DIFFERENT PATTERNS

DIFFÉRENTS MOTIFS

VERSCHIEDENE MUSTER



	15x61 (6"x24")	Angolo Interno 20x10x15 (8"x4"x6")	Angolo Esterno 20x10x15 (8"x4"x6")
MULTICOLOR	J86621	J87225	J87229
GREY	J86619	J87224	J87228
WHITE	J86620	J87226	J87230
BEIGE	J86618	J87223	J87227
SPESSORE THICKNESS	7-11 mm	7-11 mm	7-11 mm
KG/M²	18,43	-	-
PZ/BOX	11	6	6
M²/BOX	1,02	-	-
BOX/PALLET	48	-	-
M²/PALLET	48,96	-	-
KG/PALLET	902,3	-	-
€ <1 PALLET	47,40/m²	20,00 pz/pce	17,90 pz/pce
€ >1 PALLET	39,50/m²	20,00 pz/pce	17,90 pz/pce

Contributo spese imballo € 10,00/pal (netto). - Packing charges € 10,00/pal (net)

wall
Cubics - Multicolor 15x61



0,07%



A • HA • LA



OK



> 60 N/mm²



6



5



Classe V





wall
Gioia - Nero 15x61

floor
Woodie - Green 24x120

GIOIA

[Back to Index](#)

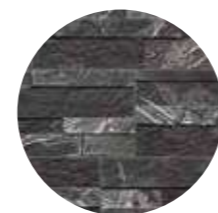

NERO



GRIGIO



BIANCO

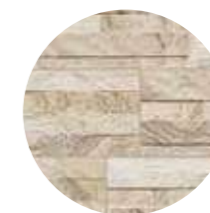

BEIGE



GREIGE



GRES PORCELLANATO SMALTATO
GLAZED PORCELAIN STONEWARE
GRES CERAME EMAILLE
GLASIERTESFEINSTEINZEUG



7-11 mm

15x61 DA PRESSA
6"x24" MOULDED



15x61
6"x24"

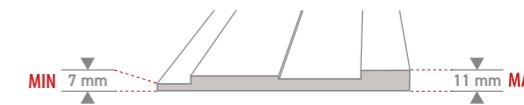

IN OUT

nero



J87459
15x61 (6"x24")



J87469
Angolo Interno
20x10x15 (8"x4"x6")



J87464
Angolo Esterno
20x10x15 (8"x4"x6")

greige



J87457
15x61 (6"x24")



J87467
Angolo Interno
20x10x15 (8"x4"x6")



J87462
Angolo Esterno
20x10x15 (8"x4"x6")

grigio



J87458
15x61 (6"x24")



J87468
Angolo Interno
20x10x15 (8"x4"x6")



J87463
Angolo Esterno
20x10x15 (8"x4"x6")

white



J87456
15x61 (6"x24")



J87466
Angolo Interno
20x10x15 (8"x4"x6")



J87461
Angolo Esterno
20x10x15 (8"x4"x6")

Abbinamenti suggeriti
Suggested matchings
Combinaison conseille
Kombinationsvorschläge

LOFT

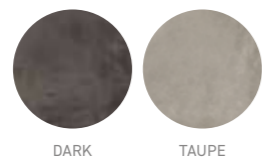

DARK

TAUPE

DARING



DARK

GREIGE

DOCKS



LIGHT GREY

BALTIC



DARK GREY

Abbinamenti suggeriti
Suggested matchings
Combinaison conseille
Kombinationsvorschläge

VOLCANO



WHITE

GREY

COTTAGE

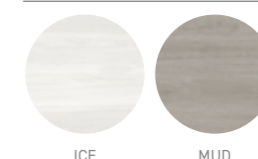

ICE

MUD

BALTIC



WHITE

DOCKS



WHITE

IN OUT

beige



J87455
15x61 (6"x24")

J87465
Angolo Interno
20x10x15 (8"x4"x6")

J87460
Angolo Esterno
20x10x15 (8"x4"x6")



wall
Gioia - Beige 15x61

nero sviluppo grafico 15x61 (6"x24")



215 15x61

GRAFICHE DIVERSE
DIFFERENT PATTERNS
DIFFÉRENTS MOTIFS
VERSCHIEDENE MUSTER

	15x61 (6"x24")	Angolo Interno 20x10x15 (8"x4"x6")	Angolo Esterno 20x10x15 (8"x4"x6")
NERO	J87459	J87469	J87464
GRIGIO	J87458	J87468	J87463
BIANCO	J87456	J87466	J87461
BEIGE	J87455	J87465	J87460
GREIGE	J87457	J87467	J87462
SPESSORE THICKNESS	7-11 mm	7-11 mm	7-11 mm
KG/M²	18,43	-	-
PZ/BOX	11	6	6
M²/BOX	1,02	-	-
BOX/PALLET	48	-	-
M²/PALLET	48,96	-	-
KG/PALLET	902,3	-	-
€ <1 PALLET	51,60/m²	20,00 pz/pce	17,90 pz/pce
€ >1 PALLET	43,00/m²	20,00 pz/pce	17,90 pz/pce

Contributo spese imballo € 10,00/pal (netto). - Packing charges € 10,00/pal (net)

Abbinamenti suggeriti
Suggested matchings
Combinaison conseillée
Kombinationsvorschläge

PROVENCE

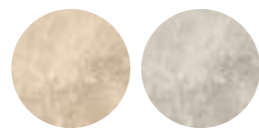

CREAM LIGHT GREY

TIMELESS

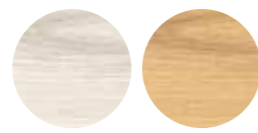

IVORY HONEY

TERRE
D'OTRANTO



CREAM

TERRE
D'OTRANTO



IVORY



0,09%



A • HA • LA



OK



> 60 N/mm²



6



5

Greige,
Nero



Classe IV

Beige,
Bianco,
Grigio



Classe V





wall
Inwood 3D - Multicolor 15x61

[Back to Index](#)

INWOOD 3D

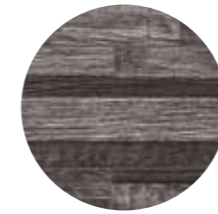

BLACK



MULTICOLOR



BEIGE



GRES PORCELLANATO SMALTATO
GLAZED PORCELAIN STONEWARE
GRES CERAME EMAILLE
GLASIERTESFEINSTEINZEUG

Coordinato con:
Coordinated with:
INWOOD
SEZ. FORESTA DI
GRES
PG. 247



7-11 mm

15x61 DA PRESSA
6"x24" MOULDED



15x61
6"x24"

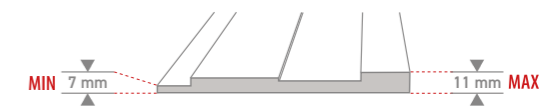

IN OUT

black



J87173
15x61 (6"x24")



J87359
Angolo Interno
20x10x15 (8"x4"x6")

J87356
Angolo Esterno
20x10x15 (8"x4"x6")



Inwood 3D - Black 15x61

Abbinamenti suggeriti
Suggested matchings
Combinaison conseillée
Kombinationsvorschläge

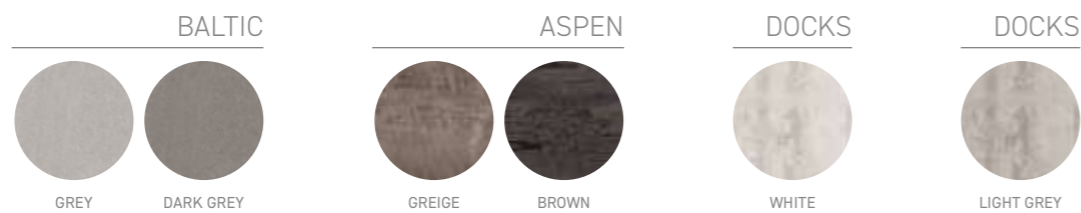

IN OUT

multicolor



J87174
15x61 (6"x24")



J87360
Angolo Interno
20x10x15 (8"x4"x6")

J87357
Angolo Esterno
20x10x15 (8"x4"x6")

beige



J87172
15x61 (6"x24")



J87358
Angolo Interno
20x10x15 (8"x4"x6")

J87355
Angolo Esterno
20x10x15 (8"x4"x6")

Abbinamenti suggeriti
Suggested matchings
Combinaison conseillée
Kombinationsvorschläge

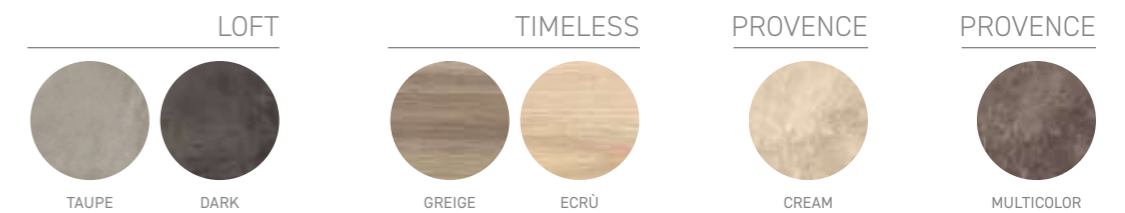

INWOOD 3D

black sviluppo grafico 15x61 (6"x24")

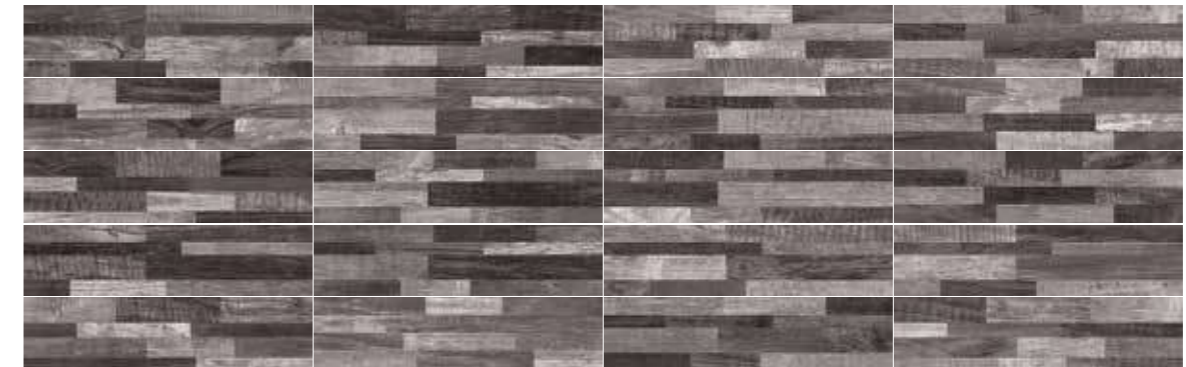

215 15x61

GRAFICHE DIVERSE
DIFFERENT PATTERNS
DIFFÉRENTS MOTIFS
VERSCHIEDENE MUSTER



	15x61 (6"x24")	Angolo Interno 20x10x15 (8"x4"x6")	Angolo Esterno 20x10x15 (8"x4"x6")
BLACK	J87173	J87359	J87356
MULTICOLOR	J87174	J87360	J87357
BEIGE	J87172	J87358	J87355
SPESSORE THICKNESS	7-11 mm	7-11 mm	7-11 mm
KG/M²	18,75	-	-
PZ/BOX	11	6	6
M²/BOX	1,02	-	-
BOX/PALLET	48	-	-
M²/PALLET	48,96	-	-
KG/PALLET	918,7	-	-
€ <1 PALLET	47,40/m²	20,00 pz/pce	17,90 pz/pce
€ >1 PALLET	39,50/m²	20,00 pz/pce	17,90 pz/pce

Contributo spese imballo € 10,00/pal (netto). - Packing charges € 10,00/pal (net)

wall
Inwood 3D - Multicolor 15x61

floor
Ardesie - Beige Strong 30,5x60,5



0,07%



A • HA • LA



OK



55,7 N/mm²



6



5



Classe V





wall
Loft 3D - White 15x61

[Back to Index](#)

LOFT 3D



DARK



GREY



LIGHT GREY



WHITE



BEIGE



TAUPE



GRES PORCELLANATO SMALTATO
GLAZED PORCELAIN STONEWARE
GRES CERAME EMAILLE
GLASIERTESFEINSTEINZEUG

Coordinato con:
Coordinated with:
LOFT
SEZ. LE MATERIE
PG. 525



7-11 mm



15x61
6"x24"

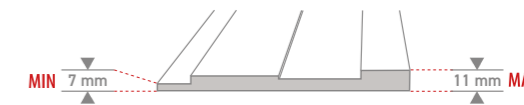



wall
Loft 3D - Dark 15x61

floor
Loft - Grey 100x100 H20

IN OUT

dark



J89281
15x61 (6"x24")



J89293
Angolo Interno
20x10x15 (8"x4"x6")



J89287
Angolo Esterno
20x10x15 (8"x4"x6")

light grey



J89283
15x61 (6"x24")



J89295
Angolo Interno
20x10x15 (8"x4"x6")



J89289
Angolo Esterno
20x10x15 (8"x4"x6")

grey



J89282
15x61 (6"x24")



J8294
Angolo Interno
20x10x15 (8"x4"x6")



J89288
Angolo Esterno
20x10x15 (8"x4"x6")

white



J89285
15x61 (6"x24")



J89297
Angolo Interno
20x10x15 (8"x4"x6")



J89291
Angolo Esterno
20x10x15 (8"x4"x6")

Abbinamenti suggeriti
Suggested matchings
Combinaison conseille
Kombinationsvorschläge

LOFT

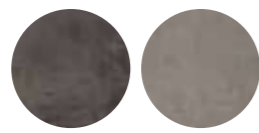

DARK

GREY

TIMELESS

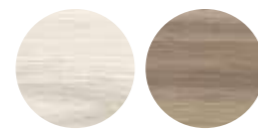

IVORY

GREIGE

PROVENCE



GREY

DOCKS



LIGHT GREY

Abbinamenti suggeriti
Suggested matchings
Combinaison conseille
Kombinationsvorschläge

LOFT

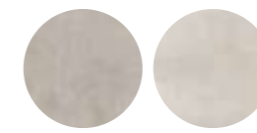

LIGHT GREY

WHITE

COTTAGE

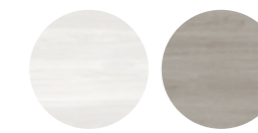

ICE

MUD

DOCKS



LIGHT GREY

BALTIC



LIGHT GREY

beige



J89280
15x61 (6"x24")

taupe



J89284
15x61 (6"x24")

IN OUT



J89292
Angolo Interno
20x10x15 (8"x4"x6")



J89286
Angolo Esterno
20x10x15 (8"x4"x6")



J89296
Angolo Interno
20x10x15 (8"x4"x6")



J89290
Angolo Esterno
20x10x15 (8"x4"x6")

taupe sviluppo grafico 15x61 (6"x24")

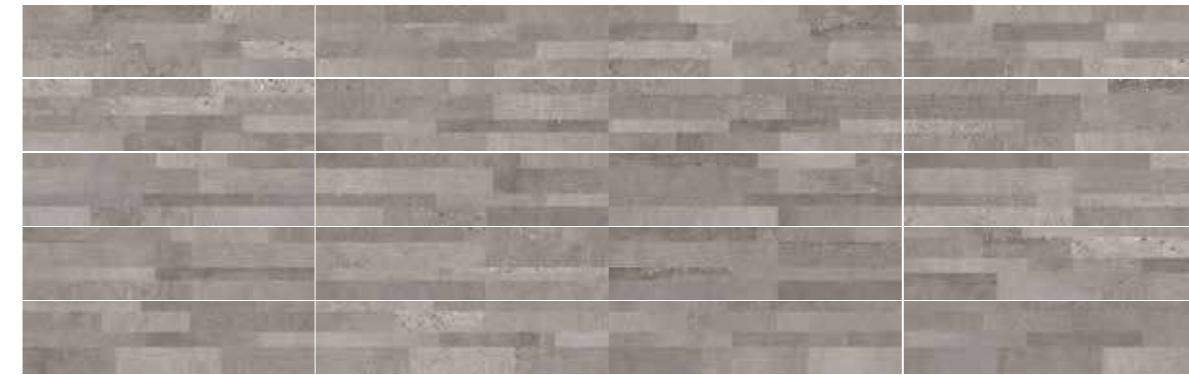

215 15x61

GRAFICHE DIVERSE
DIFFERENT PATTERNS
DIFFÉRENTS MOTIFS
VERSCHIEDENE MUSTER

	15x61 (6"x24")	Angolo Interno 20x10x15 (8"x4"x6")	Angolo Esterno 20x10x15 (8"x4"x6")
DARK	J89281	J89293	J89287
GREY	J89282	J89294	J89288
LIGHT GREY	J89283	J89295	J89289
WHITE	J89285	J89297	J89291
BEIGE	J89280	J89292	J89286
TAUPE	J89284	J89296	J89290
SPESSORE THICKNESS	7 - 11 mm	7 - 11 mm	7 - 11 mm
KG/M²	18,42	6	6
PZ/BOX	11	-	-
M²/BOX	1,02	-	-
BOX/PALLET	48	-	-
M²/PALLET	48,96	-	-
KG/PALLET	901,92	-	-
€ <1 PALLET	51,60 / m²	20,00 pz / pce	17,90 pz / pce
€ >1 PALLET	43,00 / m²	20,00 pz / pce	17,90 pz / pce

Contributo spese imballo € 10,00/pal (netto). - Packing charges € 10,00/pal (net)

Abbinamenti suggeriti
Suggested matchings
Combinaison conseillée
Kombinationsvorschläge

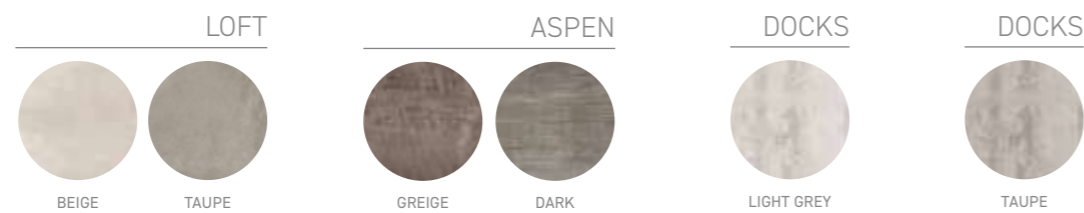

[Back to Index](#)



DARK



MULTICOLOR



SAND



BEIGE



RED



GRES PORCELLANATO SMALTATO
GLAZED PORCELAIN STONEWARE
GRES CERAME EMAILLE
GLASIERTESFEINSTEINZEUG



15x61 DA PRESSA
6"x24" MOULDED



15x61
6"x24"



wall
Lyon - Multicolor 15x61

IN OUT

dark



J88561
15x61 (6"x24")

J88648
Angolo Interno
20x10x15 (8"x4"x6")

J88643
Angolo Esterno
20x10x15 (8"x4"x6")

multicolor



J88562
15x61 (6"x24")

J88649
Angolo Interno
20x10x15 (8"x4"x6")

J88644
Angolo Esterno
20x10x15 (8"x4"x6")

Abbinamenti suggeriti
Suggested matchings
Combinaison conseillée
Kombinationsvorschläge



IN OUT

sand



J88564
15x61 (6"x24")

J88651
Angolo Interno
20x10x15 (8"x4"x6")

J88646
Angolo Esterno
20x10x15 (8"x4"x6")

beige



J88560
15x61 (6"x24")

J88647
Angolo Interno
20x10x15 (8"x4"x6")

J88642
Angolo Esterno
20x10x15 (8"x4"x6")

Abbinamenti suggeriti
Suggested matchings
Combinaison conseillée
Kombinationsvorschläge



IN OUT

red



J88563
15x61 (6"x24")



J88650
Angolo Interno
20x10x15 (8"x4"x6")

J88645
Angolo Esterno
20x10x15 (8"x4"x6")



wall
Lyon - Red 15x61

Abbinamenti suggeriti
Suggested matchings
Combinaison conseillée
Kombinationsvorschläge



dark sviluppo grafico 15x61 (6"x24")



215 15x61

GRAFICHE DIVERSE
DIFFERENT PATTERNS
DIFFÉRENTS MOTIFS
VERSCHIEDENE MUSTER

	15x61 (6"x24")	Angolo Interno 20x10x15 (8"x4"x6")	Angolo Esterno 20x10x15 (8"x4"x6")
DARK	J88561	J88648	J88643
MULTICOLOR	J88562	J88649	J88644
SAND	J88564	J88651	J88646
BEIGE	J88560	J88647	J88642
RED	J88563	J88650	J88645
SPESSORE THICKNESS	7-11 mm	7-11 mm	7-11 mm
KG/M²	19,27	-	-
PZ/BOX	11	6	6
M²/BOX	1,02	-	-
BOX/PALLET	48	-	-
M²/PALLET	48,96	-	-
KG/PALLET	943,68	-	-
€ <1 PALLET	47,40/m²	20,00 pz/pce	17,90 pz/pce
€ >1 PALLET	39,50/m²	20,00 pz/pce	17,90 pz/pce

Contributo spese imballo € 10,00/pal (netto). - Packing charges € 10,00/pal (net)





wall
Palissandro 3D - Azul 15x61

[Back to Index](#)

PALISSANDRO 3D

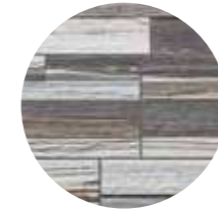

MULTICOLOR

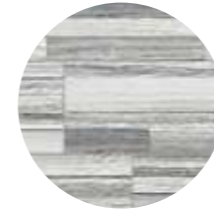

AZUL

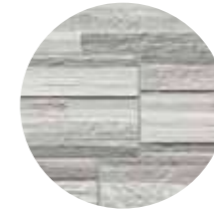

WHITE



GRES PORCELLANATO SMALTATO
GLAZED PORCELAIN STONEWARE
GRES CERAME EMAILLE
GLASIERTESFEINSTEINZEUG

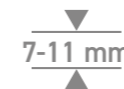

15x61 DA PRESSA
6"x24" MOULDED



15x61
6"x24"

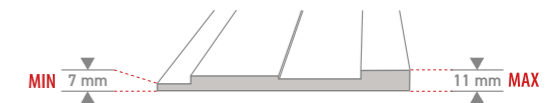

IN OUT

multicolor



J87447
15x61 (6"x24")



J87453
Angolo Interno
20x10x15 (8"x4"x6")

J87450
Angolo Esterno
20x10x15 (8"x4"x6")

azul



J87446
15x61 (6"x24")



J87452
Angolo Interno
20x10x15 (8"x4"x6")

J87449
Angolo Esterno
20x10x15 (8"x4"x6")

Abbinamenti suggeriti
Suggested matchings
Combinaison conseille
Kombinationsvorschläge



IN OUT

white



J87448
15x61 (6"x24")



J87454
Angolo Interno
20x10x15 (8"x4"x6")

J87451
Angolo Esterno
20x10x15 (8"x4"x6")



wall
Palissandro 3D - Multicolor 15x61

Abbinamenti suggeriti
Suggested matchings
Combinaison conseille
Kombinationsvorschläge



PALISSANDRO 3D

azul sviluppo grafico 15x61 (6"x24")



215 15x61

GRAFICHE DIVERSE
DIFFERENT PATTERNS
DIFFÉRENTS MOTIFS
VERSCHIEDENE MUSTER

	15x61 (6"x24")	Angolo Interno 20x10x15 (8"x4"x6")	Angolo Esterno 20x10x15 (8"x4"x6")
MULTICOLOR	J87447	J87453	J87450
AZUL	J87446	J87452	J87449
WHITE	J87448	J87454	J87451
SPESSORE THICKNESS	7-11 mm	7-11 mm	7-11 mm
KG/M²	18,43	-	-
PZ/BOX	11	6	6
M²/BOX	1,02	-	-
BOX/PALLET	48	-	-
M²/PALLET	48,96	-	-
KG/PALLET	902,3	-	-
€ <1 PALLET	47,40/m²	20,00 pz/pce	17,90 pz/pce
€ >1 PALLET	39,50/m²	20,00 pz/pce	17,90 pz/pce

Contributo spese imballo € 10,00/pal (netto). - Packing charges € 10,00/pal (net)

wall
Palissandro 3D - White 15x61

floor
Volcano - Grey 80x80



0,05%



A • HA • LA



OK



> 60N/mm²



6



5



Classe V



V4

QUARZI 3D

[Back to Index](#)



MULTICOLOR



GREY



WHITE



GRES PORCELLANATO SMALTATO
GLAZED PORCELAIN STONEWARE
GRES CERAME EMAILLE
GLASIERTESFEINSTEINZEUG

Coordinato con:
Coordinated with:
QUARZI
SEZ. PIETRE E MARMI
PG. 427



15x61 DA PRESSA
6"x24" MOULDED



15x61
6"x24"



wall
Quarzi 3D - Grey 15x61

IN OUT

multicolor



J87438
15x61 (6"x24")

J87444
Angolo Interno
20x10x15 (8"x4"x6")

J87441
Angolo Esterno
20x10x15 (8"x4"x6")

grey



J87437
15x61 (6"x24")

J87443
Angolo Interno
20x10x15 (8"x4"x6")

J87440
Angolo Esterno
20x10x15 (8"x4"x6")

Abbinamenti suggeriti
Suggested matchings
Combinaison conseille
Kombinationsvorschläge



IN OUT

white



J87439
15x61 (6"x24")

J87445
Angolo Interno
20x10x15 (8"x4"x6")

J87442
Angolo Esterno
20x10x15 (8"x4"x6")



Quarzi 3D - Multicolor 15x61

Abbinamenti suggeriti
Suggested matchings
Combinaison conseille
Kombinationsvorschläge

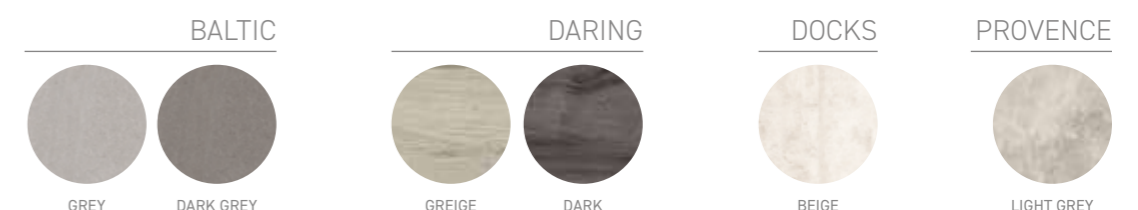

QUARZI 3D

grey sviluppo grafico 15x61 (6"x24")



215 15x61

GRAFICHE DIVERSE

DIFFERENT PATTERNS
DIFFÉRENTS MOTIFS
VERSCHIEDENE MUSTER



	15x61 (6"x24")	Angolo Interno 20x10x15 (8"x4"x6")	Angolo Esterno 20x10x15 (8"x4"x6")
MULTICOLOR	J87438	J87444	J87441
GREY	J87437	J87443	J87440
WHITE	J87439	J87445	J87442
SPESSORE THICKNESS	7-11 mm	7-11 mm	7-11 mm
KG/M²	18,43	-	-
PZ/BOX	11	6	6
M²/BOX	1,02	-	-
BOX/PALLET	48	-	-
M²/PALLET	48,96	-	-
KG/PALLET	902,3	-	-
€ <1 PALLET	47,40/m²	20,00 pz/pce	17,90 pz/pce
€ >1 PALLET	39,50/m²	20,00 pz/pce	17,90 pz/pce

Contributo spese imballo € 10,00/pal (netto). - Packing charges € 10,00/pal (net)

wall
Quarzi 3D - Grey 15x61

floor
Bricola - Noce 20x120



0,07%



A • HA • LA



OK



> 55 N/mm²



6



5



Classe V





wall
Tiffany - Grey 15x61

TIFFANY

[Back to Index](#)

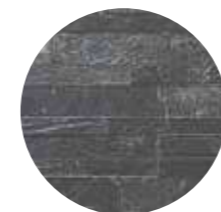

DARK



GREY



WHITE

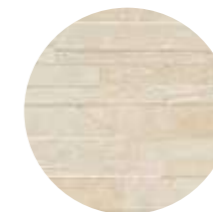

BEIGE



BROWN



GRES PORCELLANATO SMALTATO
GLAZED PORCELAIN STONEWARE
GRES CERAME EMAILLE
GLASIERTESFEINSTEINZEUG



7-11 mm

15x61 DA PRESSA
6"x24" MOULDED



15x61
6"x24"

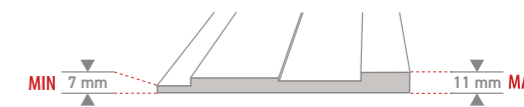

IN OUT

dark



J87342
15x61 (6"x24")



J87352
Angolo Interno
20x10x15 (8"x4"x6")



J87347
Angolo Esterno
20x10x15 (8"x4"x6")

grey

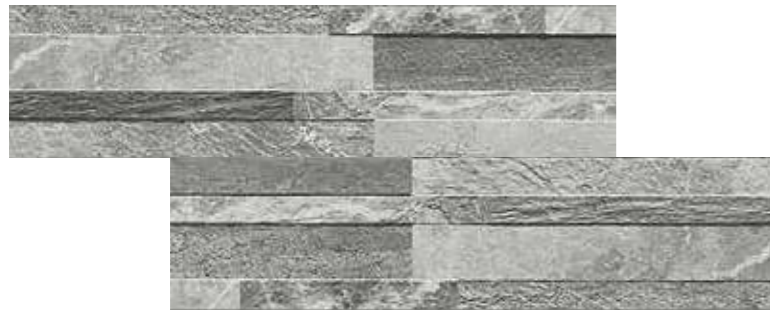

J87343
15x61 (6"x24")



J87353
Angolo Interno
20x10x15 (8"x4"x6")



J87348
Angolo Esterno
20x10x15 (8"x4"x6")

Abbinamenti suggeriti
Suggested matchings
Combinaison conseille
Kombinationsvorschläge



IN OUT

white



J87344
15x61 (6"x24")



J87354
Angolo Interno
20x10x15 (8"x4"x6")



J87349
Angolo Esterno
20x10x15 (8"x4"x6")

beige



J87340
15x61 (6"x24")



J87350
Angolo Interno
20x10x15 (8"x4"x6")



J87345
Angolo Esterno
20x10x15 (8"x4"x6")

Abbinamenti suggeriti
Suggested matchings
Combinaison conseille
Kombinationsvorschläge



IN OUT

brown



J87341
15x61 (6"x24")

J87351
Angolo Interno
20x10x15 (8"x4"x6")

J87346
Angolo Esterno
20x10x15 (8"x4"x6")



wall
Tiffany - Brown 15x61

Abbinamenti suggeriti
Suggested matchings
Combinaison conseillée
Kombinationsvorschläge

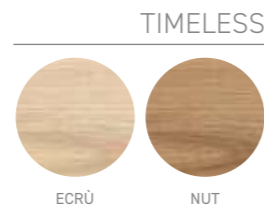
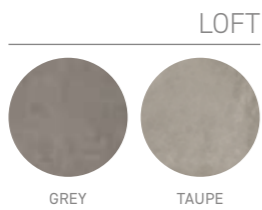

grey sviluppo grafico 15x61 (6"x24")

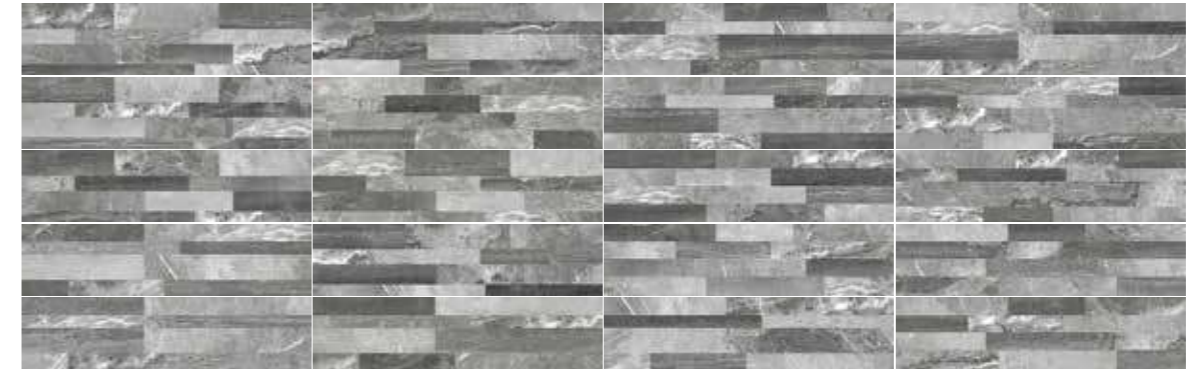

215 15x61
GRAFICHE DIVERSE
DIFFERENT PATTERNS
DIFFÉRENTS MOTIFS
VERSCHIEDENE MUSTER

	15x61 (6"x24")	Angolo Interno 20x10x15 (8"x4"x6")	Angolo Esterno 20x10x15 (8"x4"x6")
DARK	J87342	J87352	J87347
GREY	J87343	J87353	J87348
WHITE	J87344	J87354	J87349
BEIGE	J87340	J87350	J87345
BROWN	J87341	J87351	J87346
SPESSORE THICKNESS	7-11 mm	7-11 mm	7-11 mm
KG/M ²	17,73	-	-
PZ/BOX	11	6	6
M ² /BOX	1,02	-	-
BOX/PALLET	48	-	-
M ² /PALLET	48,96	-	-
KG/PALLET	868,3	-	-
€ <1 PALLET	51,60/m ²	20,00 pz/pce	17,90 pz/pce
€ >1 PALLET	43,00/m ²	20,00 pz/pce	17,90 pz/pce

Contributo spese imballo € 10,00/pal (netto). - Packing charges € 10,00/pal (net)



0,07%



A • HA • LA



OK



> 50N/mm²



8



5



Classe V





wall
Timless 3D - Greige 15x61

TIMELESS 3D

[Back to Index](#)



GREIGE



ECRÙ



IVORY



HONEY



NUT



GRES PORCELLANATO SMALTATO
GLAZED PORCELAIN STONEWARE
GRES CERAME EMAILLE
GLASIERTESFEINSTEINZEUG

Coordinato con:
Coordinated with:
TIMELESS
SEZ. FORESTA DI GRES
PG. 289



7-11 mm

15x61 DA PRESSA
6"x24" MOULDED



15x61
6"x24"

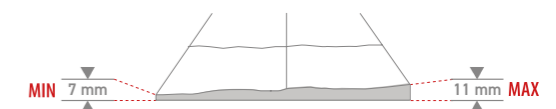



wall
Timeless 3D - Greige 15x61

floor
Provence - Light Gery 60x120

IN OUT

greige



J90454
15x61 (6"x24")

J90464
Angolo Interno
15x7,5x15 (6"x3"x6")

J90459
Angolo Esterno
15x7,5x15 (6"x3"x6")

ivory



J90456
15x61 (6"x24")

J90466
Angolo Interno
15x7,5x15 (6"x3"x6")

J90461
Angolo Esterno
15x7,5x15 (6"x3"x6")

ecrù



J90453
15x61 (6"x24")

J90463
Angolo Interno
15x7,5x15 (6"x3"x6")

J90458
Angolo Esterno
15x7,5x15 (6"x3"x6")

honey



J90455
15x61 (6"x24")

J90465
Angolo Interno
15x7,5x15 (6"x3"x6")

J90460
Angolo Esterno
15x7,5x15 (6"x3"x6")

Abbinamenti suggeriti
Suggested matchings
Combinaison conseillée
Kombinationsvorschläge

VOLCANO

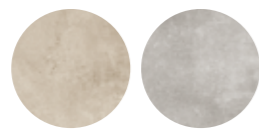

BEIGE

GREY

TIMELESS



GREIGE

ECRÙ

BALTIC



TAUPE

MANHATTAN



IVORY

Abbinamenti suggeriti
Suggested matchings
Combinaison conseillée
Kombinationsvorschläge

DOCKS

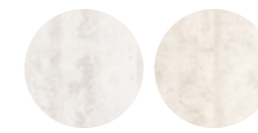

WHITE

BEIGE

TIMELESS



IVORY

HONEY

BALTIC



BEIGE

PROVENCE



CREAM

nut



J90457
15x61 (6"x24")

IN OUT



J90467
Angolo Interno
15x7,5x15 (6"x3"x6")



J90462
Angolo Esterno
15x7,5x15 (6"x3"x6")



wall
Timeless 3D - Greige 15x61

Abbinamenti suggeriti
Suggested matchings
Combinaison conseillée
Kombinationsvorschläge

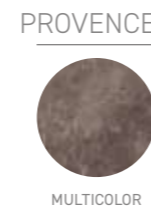
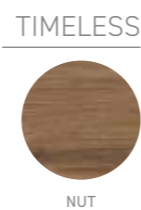
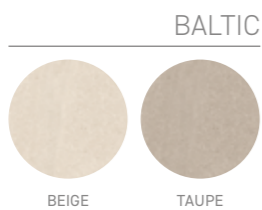

nut sviluppo grafico 15x61 (6"x24")



215 15x61
GRAFICHE DIVERSE
DIFFERENT PATTERNS
DIFFÉRENTS MOTIFS
VERSCHIEDENE MUSTER

	15x61 (6"x24")	Angolo Interno 15x7,5x15 (6"x3"x6")	Angolo Esterno 15x7,5x15 (6"x3"x6")
GREIGE	J90454	J90464	J90459
ECRÙ	J90453	J90463	J90458
IVORY	J90456	J90466	J90461
HONEY	J90455	J90465	J90460
NUT	J90457	J90467	J90462
SPESSORE THICKNESS	7-11 mm	7-11 mm	7-11 mm
KG/M ²	18,68	-	-
PZ/BOX	11	6	6
M ² /BOX	1,02	-	-
BOX/PALLET	48	-	-
M ² /PALLET	48,96	-	-
KG/PALLET	914,88	-	-
€ <1 PALLET	51,60/m ²	20,00 pz/pce	17,90 pz/pce
€ >1 PALLET	43,00/m ²	20,00 pz/pce	17,90 pz/pce

Contributo spese imballo € 10,00/pal (netto). - Packing charges € 10,00/pal (net)



< 0,15%



A • HA • LA



OK



> 55 N/mm²



7



5

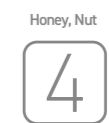

Classe IV



Classe V





wall
Volcano 3D - Taupe 15x61

VOLCANO 3D

[Back to Index](#)



DARK



GREY



WHITE



BEIGE

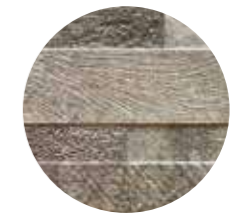

TAUPE



GRES PORCELLANATO SMALTATO
GLAZED PORCELAIN STONEWARE
GRES CERAME EMAILLE
GLASIERTESFEINSTEINZEUG

Coordinato con:
Coordinated with:
VOLCANO
SEZ. LE MATERIE
PG. 623

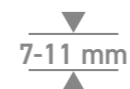

15x61 DA PRESSA
6"x24" MOULDED



15x61
6"x24"



IN OUT

dark



J88899
15x61 (6"x24")

J88978
Angolo Interno
20x10x15 (8"x4"x6")

J88973
Angolo Esterno
20x10x15 (8"x4"x6")

white



J88902
15x61 (6"x24")

J88981
Angolo Interno
20x10x15 (8"x4"x6")

J88976
Angolo Esterno
20x10x15 (8"x4"x6")

grey



J88900
15x61 (6"x24")

J88979
Angolo Interno
20x10x15 (8"x4"x6")

J88974
Angolo Esterno
20x10x15 (8"x4"x6")

beige



J88898
15x61 (6"x24")

J88977
Angolo Interno
20x10x15 (8"x4"x6")

J88972
Angolo Esterno
20x10x15 (8"x4"x6")

Abbinamenti suggeriti
Suggested matchings
Combinaison conseillée
Kombinationsvorschläge



Abbinamenti suggeriti
Suggested matchings
Combinaison conseillée
Kombinationsvorschläge



IN OUT

taupe



J88901
15x61 (6"x24")

J88980
Angolo Interno
20x10x15 (8"x4"x6")

J88975
Angolo Esterno
20x10x15 (8"x4"x6")



wall
Volcano 3D - Taupe 15x61

taupe sviluppo grafico 15x61 (6"x24")

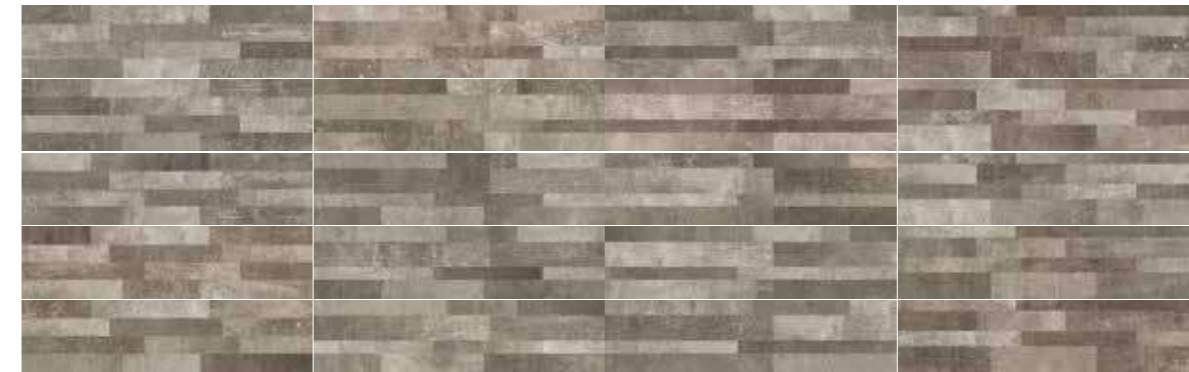

215 15x61
GRAFICHE DIVERSE
DIFFERENT PATTERNS
DIFFÉRENTS MOTIFS
VERSCHIEDENE MUSTER

	15x61 (6"x24")	Angolo Interno 20x10x15 (8"x4"x6")	Angolo Esterno 20x10x15 (8"x4"x6")
DARK	J88899	J88978	J88973
GREY	J88900	J88979	J88974
WHITE	J88902	J88981	J88976
BEIGE	J88898	J88977	J88972
TAUPE	J88901	J88980	J88975
SPESSORE THICKNESS	7-11 mm	7-11 mm	7-11 mm
KG/M ²	18,48	-	-
PZ/BOX	11	6	6
M ² /BOX	1,02	-	-
BOX/PALLET	48	48	48
M ² /PALLET	48,96	-	-
KG/PALLET	904,8	-	-
€ <1 PALLET	51,60/m ²	20,00 pz/pce	17,90 pz/pce
€ >1 PALLET	43,00/m ²	20,00 pz/pce	17,90 pz/pce

Contributo spese imballo € 10,00/pal (netto). - Packing charges € 10,00/pal (net)

Abbinamenti suggeriti
Suggested matchings
Combinaison conseillée
Kombinationsvorschläge

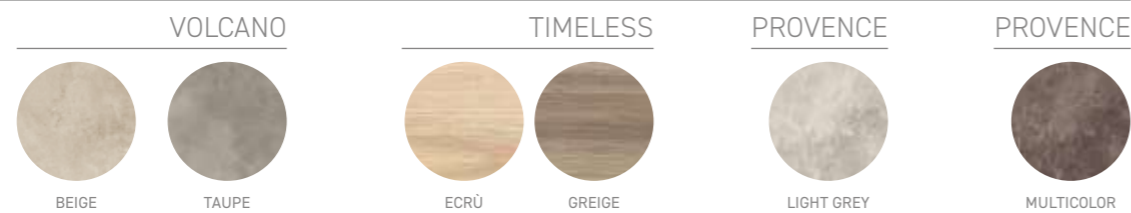



wall
Wall Art - Sand 15x61

WALL ART

[Back to Index](#)

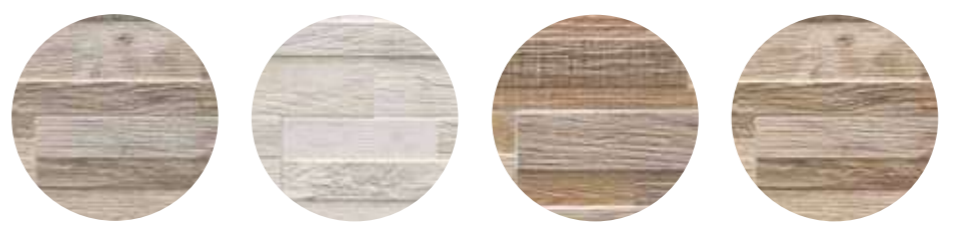

GREIGE ICE SAND TAUPE



GRES PORCELLANATO SMALTATO
GLAZED PORCELAIN STONEWARE
GRES CERAME EMAILLE
GLASIERTESFEINSTEINZEUG

IN **OUT** $\frac{7-11 \text{ mm}}$ 15x61 DA PRESSA
6"x24" MOULDED



15x61
6"x24"

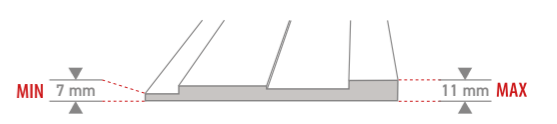

IN OUT

greige



J86736
15x61 (6"x24")



J87215
Angolo Interno
20x10x15 (8"x4"x6")



J87219
Angolo Esterno
20x10x15 (8"x4"x6")

ice



J86615
15x61 (6"x24")



J87216
Angolo Interno
20x10x15 (8"x4"x6")



J87220
Angolo Esterno
20x10x15 (8"x4"x6")

Abbinamenti suggeriti
Suggested matchings
Combinaison conseille
Kombinationsvorschläge



IN OUT

sand



J86616
15x61 (6"x24")



J87217
Angolo Interno
20x10x15 (8"x4"x6")



J87221
Angolo Esterno
20x10x15 (8"x4"x6")

taupe



J86617
15x61 (6"x24")



J87218
Angolo Interno
20x10x15 (8"x4"x6")



J87222
Angolo Esterno
20x10x15 (8"x4"x6")

Abbinamenti suggeriti
Suggested matchings
Combinaison conseille
Kombinationsvorschläge



greige sviluppo grafico 15x61 (6"x24")



215 15x61

GRAFICHE DIVERSE
DIFFERENT PATTERNS
DIFFÉRENTS MOTIFS
VERSCHIEDENE MUSTER



wall
Wall Art - Taupe 15x61

	15x61 (6"x24")	Angolo Interno 20x10x15 (8"x4"x6")	Angolo Esterno 20x10x15 (8"x4"x6")
GREIGE	J86736	J87215	J87219
ICE	J86615	J87216	J87220
SAND	J86616	J87217	J87221
TAUPE	J86617	J87218	J87222
SPESSORE THICKNESS	7-11 mm	7-11 mm	7-11 mm
KG/M²	18,43	-	-
PZ/BOX	11	6	6
M²/BOX	1,02	-	-
BOX/PALLET	48	-	-
M²/PALLET	48,96	-	-
KG/PALLET	902,3	-	-
€ <1 PALLET	47,40/m²	20,00 pz/pce	17,90 pz/pce
€ >1 PALLET	39,50/m²	20,00 pz/pce	17,90 pz/pce

Contributo spese imballo € 10,00/pal (netto). - Packing charges € 10,00/pal (net)



0,07%



A · HA · LA



OK



55,7 N/mm²



6



5



Classe V



V4



“ La Foresta di Gres è un percorso immaginario nell’innovazione tecnologica, ove la bellezza e il calore del parquet si sposano con la praticità e la durezza della ceramica. Un marchio a garanzia della più assoluta qualità ma anche di politiche produttive ecosostenibili. Ne La Foresta di Gres non ci sono alberi da abbattere ma hai tutto il piacere e la bellezza del legno.



La Foresta di Gres (the Stoneware forest) is an imaginary journey through technological innovation, where the beauty and warmth of parquet marry with the practicality and durability of ceramic tiles. A guarantee of the absolute highest quality, but also of eco-sustainable production policies. In La Foresta di Gres there are no trees to fell, but you have all the pleasure and beauty of wood.

La Foresta di Gres est un parcours imaginaire dans l'innovation technologique, où la beauté et la chaleur du parquet s'allient à la praticité et à la dureté de la céramique. Une marque synonyme de qualité, mais aussi de processus de fabrication éco-compatibles. Dans La Foresta di Gres, il n'y a pas d'arbres à couper, mais vous y trouverez tout le plaisir et la beauté du bois.

La Foresta di Gres ist eine imaginäre Wegstrecke durch technologische Innovation, in der Ästhetik und Wärme des Parketts mit der Zweckmäßigkeit und Beständigkeit der Keramik Hand in Hand gehen. Eine Marke unter Garantie höchster Qualität, aber auch für eine ökologisch sinnvolle Produktion. Für La Foresta di Gres werden keine Bäume gefällt und wir können uns doch die Ästhetik von Holz zunutze machen.

Aspen	171	Inwood	247
Bricola	181	Living	257
Cottage	191	Renaissance	267
Daring	199	Tabula	277
Ever	217	Timeless	289
Greenwood	227	Vintage	305
Hard & Soft	237	Woodie	311

ASPEN

[Back to Index](#)



DARK



BROWN

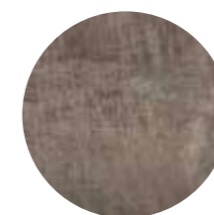

GREIGE



BEIGE



GRES PORCELLANATO SMALTATO
GLAZED PORCELAIN STONEWARE
GRES CERAME EMAILLE
GLASIERTESFEINSTEINZEUG



9,5 mm

STRONG



15x100
6"x39 1/4"



9,5 mm



20,5x100
8"x39 1/4"



15x100
6"x39 1/4"

wall
Aspen - Brown 20,5x100 - 15x100

floor
Aspen - Brown 15x100



dark



J87865 Multiformato
35,5x100 (14"x39 1/4")

J87746
20,5x100 (8"x39 1/4")

J87750
15x100 (6"x39 1/4")

J87860 STRONG
15x100 (6"x39 1/4")

brown



J87864 Multiformato
35,5x100 (14"x39 1/4")

J87745
20,5x100 (8"x39 1/4")

J87749
15x100 (6"x39 1/4")

J87859 STRONG
15x100 (6"x39 1/4")



NUOVO IMBALLO: DUE FORMATI NELLA STESSA SCATOLA (20,5x100 + 15x100)

- 3 pezzi 20,5x100 + 3 pezzi 15x100;
- Garanzia di avere il medesimo tono per entrambi i formati;
- Facilità di gestione: un solo articolo da ordinare;
- Eliminazione delle rimanenze di magazzino.

NEW PACKAGING: TWO SIZES IN THE SAME BOX (20.5X100 + 15X100)

- 3 pieces 20.5x100 + 3 pieces 15x100;
- Guarantee to have the same tone for both formats;
- Ease of management: only one item to order;
- Elimination of warehouse inventory.

NOUVEL EMBALLAGE: DEUX TAILLES DANS LA MÊME BOÎTE (20.5X100 + 15X100)

- 3 pièces 20.5x100 + 3 pièces 15x100;
- Garantie d'avoir le même ton pour les deux formats;
- Facilité de gestion: un seul article à commander;
- Élimination des stocks d'entrepôt.

NEUE VERPACKUNG: ZWEI GRÖSSEN IN DER GLEICHEN BOX (20.5X100 + 15X100)

- 3 Stück 20,5x100 + 3 Stück 15x100;
- Stellen Sie sicher, dass beide Formate den gleichen Ton haben;
- Einfache Verwaltung: nur ein Artikel zu bestellen;
- Eliminierung von Lagerbeständen.

IN R10
B

OUT STRONG
R11
C

greige



J87866 Multiformato
35,5x100 (14"x39 1/4")

J87747
20,5x100 (8"x39 1/4")

J87751
15x100 (6"x39 1/4")

J87861 STRONG
15x100 (6"x39 1/4")

beige

IN R10
B

OUT STRONG
R11
C



J87863 Multiformato
35,5x100 (14"x39 1/4")

J87744
20,5x100 (8"x39 1/4")

J87748
15x100 (6"x39 1/4")

J87858 STRONG
15x100 (6"x39 1/4")



NUOVO IMBALLO: DUE FORMATI NELLA STESSA SCATOLA (20,5x100 + 15x100)

- 3 pezzi 20,5x100 + 3 pezzi 15x100;
- Garanzia di avere il medesimo tono per entrambi i formati;
- Facilità di gestione: un solo articolo da ordinare;
- Eliminazione delle rimanenze di magazzino.

NEW PACKAGING: TWO SIZES IN THE SAME BOX (20.5X100 + 15X100)

- 3 pieces 20.5x100 + 3 pieces 15x100;
- Guarantee to have the same tone for both formats;
- Ease of management: only one item to order;
- Elimination of warehouse inventory.

NOUVEL EMBALLAGE: DEUX TAILLES DANS LA MÊME BOÎTE (20.5X100 + 15X100)

- 3 pièces 20.5x100 + 3 pièces 15x100;
- Garantie d'avoir le même ton pour les deux formats;
- Facilité de gestion: un seul article à commander;
- Élimination des stocks d'entrepôt.

NEUE VERPACKUNG: ZWEI GRÖSSEN IN DER GLEICHEN BOX (20.5X100 + 15X100)

- 3 Stück 20,5x100 + 3 Stück 15x100;
- Stellen Sie sicher, dass beide Formate den gleichen Ton haben;
- Einfache Verwaltung: nur ein Artikel zu bestellen;
- Eliminierung von Lagerbeständen.

ASPEN



floor
Aspen - Beige Strong 15x100

tarsie mix 30 pezzi randomi per scatola - 30 random pieces per box



J87990
20,3x20,3 (8"x8")



wall
Aspen - Tarsie Mix 20,3x20,3
Aspen - Greige 20,5x100

floor
Aspen - Dark 20,5x100

greige sviluppo grafico 15x100 (6"x39 1/2")



31 15x100

GRAFICHE DIVERSE
DIFFERENT PATTERNS
DIFFÉRENTS MOTIFS
VERSCHIEDENE MUSTER

31 20,5x100

GRAFICHE DIVERSE
DIFFERENT PATTERNS
DIFFÉRENTS MOTIFS
VERSCHIEDENE MUSTER

	Multiformato 35,5x100 (14"x39 1/2")	20,5x100 (8"x39 1/2")	15x100 (6"x39 1/2")	STRONG 15x100 (6"x39 1/2")	Tarsie Mix 20,3x20,3 (8"x8")
DARK	J87865	J87746	J87750	J87860	J87990
BROWN	J87864	J87745	J87749	J87859	J87990
GREIGE	J87866	J87747	J87751	J87861	J87990
BEIGE	J87863	J87744	J87748	J87858	J87990
SPESSORE THICKNESS	9,5 mm	9,5 mm	9,5 mm	9,5 mm	9,5 mm
KG/M²	21,46	21,46	21,46	21,46	18,10
PZ/BOX	3	6	8	8	30
M²/BOX	1,07	1,23	1,23	1,23	1,24
BOX/PALLET	36	36	42	42	60
M²/PALLET	38,52	44,28	51,66	51,66	74,4
KG/PALLET	763,2	950,40	1108,8	1108	1347
€ <1 PALLET	60,00/m²	55,80/m²	55,80/m²	60,00/m²	59,40/m²
€ >1 PALLET	50,00/m²	46,50/m²	46,50/m²	50,00/m²	49,50/m²

	Battiscopa 7,5x100 (3"x39 1/2")	Gradino+Toro 15x100x4 (6"x39 1/2"x1 3/4")	Gradino+Toro 30x100x4 (12"x39 1/2"x1 3/4")	Angolo+Toro Dx 15x100x4 (6"x39 1/2"x1 3/4")	Angolo+Toro Sx 15x100x4 (6"x39 1/2"x1 3/4")	Elemento a L STRONG 15x100x5 (6"x39 1/2"x2")
DARK	J87754	J87982	J87987	J87972	J87977	J87967
BROWN	J87753	J87981	J87986	J87971	J87976	J87966
GREIGE	J87755	J87983	J87988	J87973	J87978	J87968
BEIGE	J87752	J87980	J87985	J87970	J87975	J87965
PZ/BOX	6	2	1	2	2	2
€ /UM	13,30 pz/pce	50,00 pz/pce	150,00 pz/pce	195,00 pz/pce	195,00 pz/pce	54,00 pz/pce

Contributo spese imballo € 10,00/pal (netto). - Packing charges € 10,00/pal (net)

0,08%
 A • HA • LA
 OK
 52,8 N/mm²
 6
 5
 4
 5
 R10_B
 R11_C
 V4

Dark, Brown
 Beige, Greige
 STRONG

Dcof: Wet 0,46
 Pendulum: Dry 40 • Wet 26
 Dcof: Wet 0,70
 Pendulum: Dry 50 • Wet 40



wall
New York - Black 6x25

floor
Bricola - Miele 20x120

[Back to Index](#)

BRICOLA

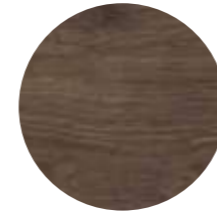

EBANO



GREIGE



FUMO



BIANCO



MIELE



NOCE



GRES PORCELLANATO A IMPASTO COLORATO
FULL BODY PORCELAIN STONEWARE
GRES CERAME A PATE COLOREE
DURCHGEFÄRBTES FEINSTEINZEUG

9,5 mm



30x120 rett.
12"x48" rect.



20x120 rett.
8"x48" rect.

ebano



J85993
30x120 (12"x48") rett./rect.

J85987
20x120 (8"x48") rett./rect.



J87274 Tendina
30x120 (12"x48")



J86138 Spina
50,6x30,5 (20"x12")



greige



J86150
30x120 (12"x48") rett./rect.

J86149
20x120 (8"x48") rett./rect.



J87276 Tendina
30x120 (12"x48")



J86172 Spina
50,6x30,5 (20"x12")



fumo



J85996
30x120 (12"x48") rett./rect.

J85990
20x120 (8"x48") rett./rect.



J87275 Tendina
30x120 (12"x48")



J86141 Spina
50,6x30,5 (20"x12")



bianco



J85997
30x120 (12"x48") rett./rect.

J85991
20x120 (8"x48") rett./rect.



J87273 Tendina
30x120 (12"x48")



J86142 Spina
50,6x30,5 (20"x12")



miele



J85994
30x120 (12"x48") rett./rect.

J85988
20x120 (8"x48") rett./rect.



J87277 Tendina
30x120 (12"x48")



J86139 Spina
50,6x30,5 (20"x12")



noce



J85995
30x120 (12"x48") rett./rect.

J85989
20x120 (8"x48") rett./rect.



J87278 Tendina
30x120 (12"x48")



J86140 Spina
50,6x30,5 (20"x12")



noce sviluppo grafico 20x120 rett. (8"x48") rett.



24 30x120





















GRAFICHE DIVERSE

DIFFERENT PATTERNS
DIFFÉRENTS MOTIFS
VERSCHIEDENE MUSTER

36 20x120

GRAFICHE DIVERSE

DIFFERENT PATTERNS
DIFFÉRENTS MOTIFS
VERSCHIEDENE MUSTER

				
	30x120 rett. (12"x48") rett.	20x120 rett. (8"x48") rett.	Tendina 30x120 (12"x48")	Spina 50,6x30,5 (20"x12")
	EBANO J85993	J85987	J87274	J86138
	GREIGE J86150	J86149	J87276	J86172
	FUMO J85996	J85990	J87275	J86141
	BIANCO J85997	J85991	J87273	J86142
	MIELE J85994	J85988	J87277	J86139
	NOCE J85995	J85989	J87278	J86140
SPESSORE THICKNESS	9,5 mm	9,5 mm	9,5 mm	9,5 mm
KG/M ²	22,13	21,37	22,13	22,13
PZ/BOX	3	4	4	2
M ² /BOX	1,08	0,96	-	-
BOX/PALLET	40	48	-	-
M ² /PALLET	43,20	46,08	-	-
KG/PALLET	956	985	-	-
€ < 1 PALLET	68,70/m ²	68,70/m ²	140,20/m ²	29,90 pz/pce
€ > 1 PALLET	59,70/m ²	59,70/m ²	140,20/m ²	29,90 pz/pce
				
	Battiscopa 8x45 (3 1/2"x18")	Gradino+Toro 33x120x4 (13"x48"x1 1/2")	Angolo+Toro Dx 33x120x4 (13"x48"x1 1/2")	Angolo+Toro Sx 33x120x4 (13"x48"x1 1/2")
	EBANO J86049	J86738	J86744	J86750
	GREIGE J86174	J86740	J86746	J86752
	FUMO J86052	J86739	J86745	J86751
	BIANCO J86053	J86737	J86743	J86749
	MIELE J86050	J86741	J86747	J86753
	NOCE J86051	J86742	J86748	J86754
PZ/BOX	30	2	1	1
€/UM	5,40/ml	179,00 pz/pce	239,00 pz/pce	239,00 pz/pce

Contributo spese imballo € 10,00/pal (netto). - Packing charges € 10,00/pal (net)



< 0,1%



A • HA • LA



OK



51,4N/mm²



6



5



Classe IV



Classe V



Dcof: Wet 0,58
Pendulum:
Dry 40 • Wet 25



V2



floor
Cottage - Ecrù 20x120

[Back to Index](#)

COTTAGE

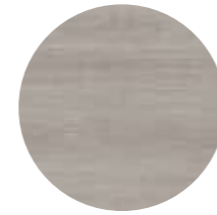

MUD



ICE



IVORY



ECRÙ



HONEY



GRES PORCELLANATO SMALTATO
GLAZED PORCELAIN STONEWARE
GRES CERAME EMAILLE
GLASIERTESFEINSTEINZEUG

9,5 mm



20x120 rett.
8"x48" rect.



mud



J88077
20x120 rett.
(8"x48") rect.



J88142 Tendina
20x120 rett.
(8"x48") rect.

ice



J88075
20x120 rett.
(8"x48") rect..



J88140 Tendina
20x120 rett.
(8"x48") rect.

ivory



J88076
20x120 rett.
(8"x48") rect.



J88141 Tendina
20x120 rett.
(8"x48") rect.

ecrù



J88074
20x120 rett.
(8"x48") rect.



J88138 Tendina
20x120 rett.
(8"x48") rect.



honey



J87891
20x120 rett.
(8"x48") rect.



J88139 Tendina
20x120 rett.
(8"x48") rect.

honey sviluppo grafico 20x120 rett. (8"x48") rett.

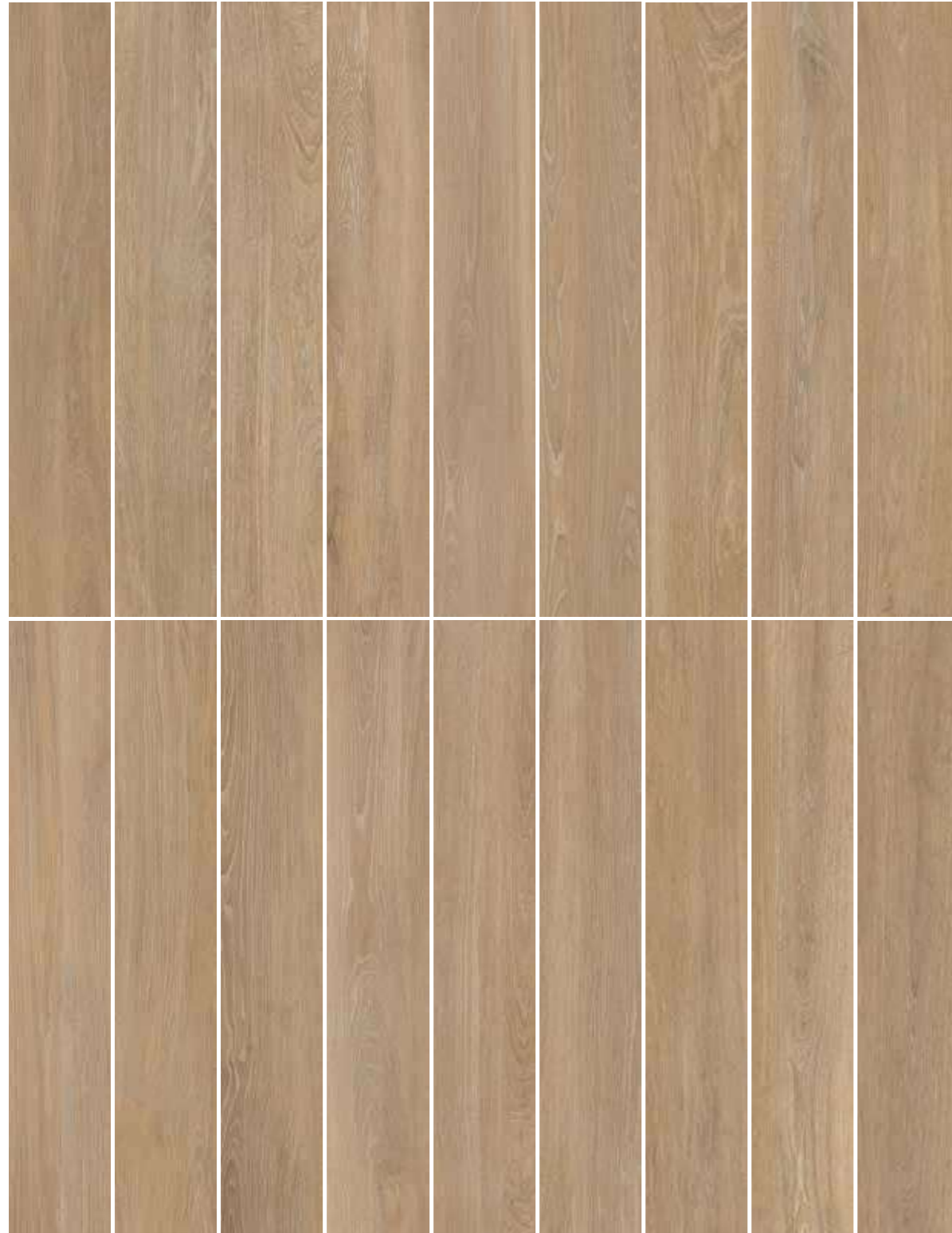

18 20x120

GRAFICHE DIVERSE

DIFFERENT PATTERNS
DIFFÉRENTS MOTIFS
VERSCHIEDENE MUSTER

	20x120 rett. (8"x48") rett.	Tendina 20x120 rett. (8"x48") rett.
MUD	J88077	J88142
ICE	J88075	J88140
IVORY	J88076	J88141
ECRÙ	J88074	J88138
HONEY	J87891	J88139
SPESSORE THICKNESS	9,5 mm	9,5 mm
KG/M²	20,78	22,19
PZ/BOX	4	4
M²/BOX	0,96	0,96
BOX/PALLET	40	-
M²/PALLET	46,08	-
KG/PALLET	957,6	826,7
€ <1 PALLET	68,70/m²	140,20/m²
€ >1 PALLET	59,70/m²	140,20/m²

	Battiscopa 8x45 (3 1/2"x18")	Gradino+Toro 33x120x4 (13"x48"x1 1/2")	Angolo+Toro Dx 33x120x4 (13"x48"x1 1/2")	Angolo+Toro Sx 33x120x4 (13"x48"x1 1/2")
MUD	J88162	J88147	J88152	J88157
ICE	J88160	J88145	J88150	J88155
IVORY	J88161	J88146	J88151	J88156
ECRÙ	J88158	J88143	J88148	J88153
HONEY	J88159	J88144	J88149	J88154
PZ/BOX	30	2	1	1
€/UM	5,40/ml	179,00 pz/pce	239,00 pz/pce	239,00 pz/pce

Contributo spese imballo € 10,00/pal (netto). - Packing charges € 10,00/pal (net)



DARING

[Back to Index](#)



GRES PORCELLANATO SMALTATO
 GLAZED PORCELAIN STONEWARE
 GRES CERAME EMAILLE
 GLASIERTESFEINSTEINZEUG

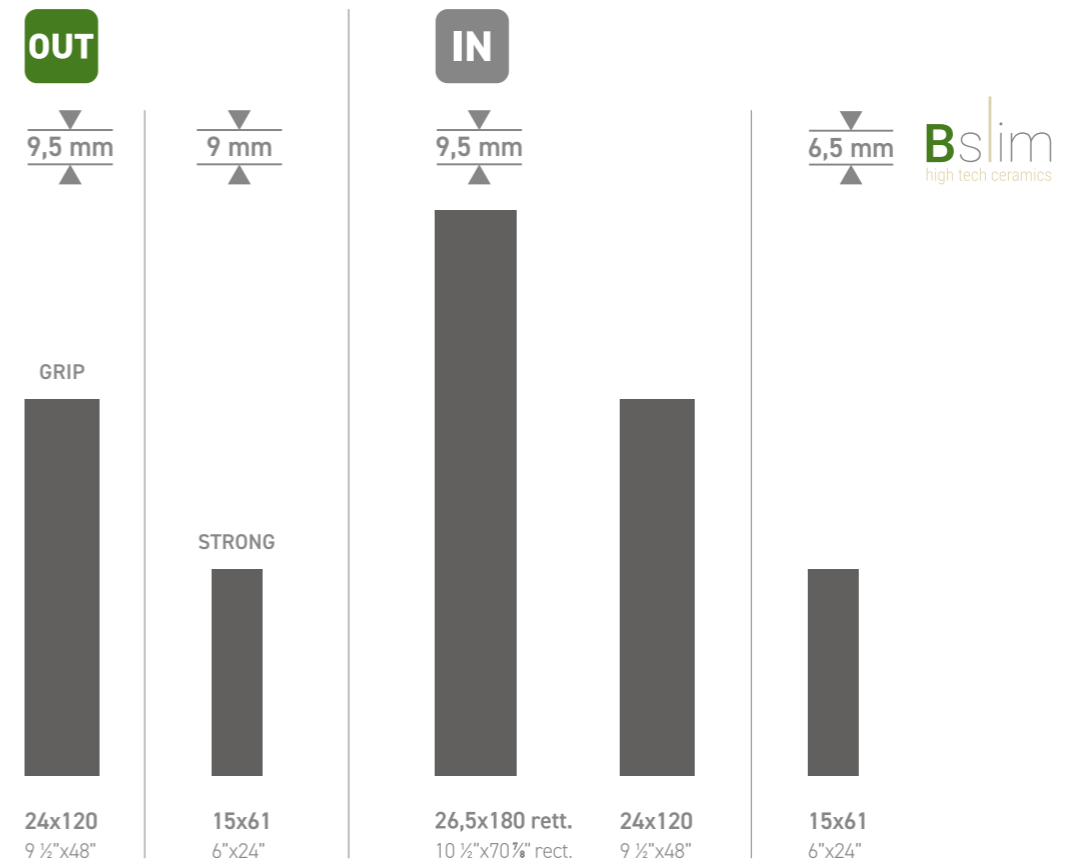

floor
 Daring - Ecrù 26,5x180
 Daring - Ecrù Infinity 24x120



dark



J88941
26,5x180 rett. (10 1/2"x70 7/8") rett.



J88439
24x120 (9 1/2"x48")

infinity dark



J88947 Infinity
26,5x180 rett. (10 1/2"x70 7/8") rett.

infinity dark



J88953 Infinity
24x120 (9 1/2"x48")

tendina dark



J88959 Tendina
24x120 (9 1/2"x48")



IN R10
B

OUT R11
C

IN R10
B

greige



J88943
26,5x180 rett. (10 1/2"x70 7/8") rect.



J88441
24x120 (9 1/2"x48")

Bslim
high tech ceramics



J88429 BSlim
15x61 (6"x24")



J88909 GRIP
24x120 (9 1/2"x48")



J88435 STRONG
15x61 (6"x24")

infinity greige



J88949 Infinity
26,5x180 rett. (10 1/2"x70 7/8") rect.

infinity greige



J88955 Infinity
24x120 (9 1/2"x48")

tendina greige



J88961 Tendina
24x120 (9 1/2"x48")

IN R10
B

OUT R11
C

ivory



J88945
26,5x180 rett. (10 1/2"x70 7/8") rect.



J88443
24x120 (9 1/2"x48")

Bslim
high tech ceramics



J88431 BSlim
15x61 (6"x24") 



J88437 STRONG
15x61 (6"x24")

infinity ivory



J88951 Infinity
26,5x180 rett. (10 1/2"x70 7/8") rect.

infinity ivory



J88957 Infinity
24x120 (9 1/2"x48")

tendina ivory



J88963 Tendina
24x120 (9 1/2"x48")

IN R10
B

IN R10
B

OUT R11
C

IN R10
B

ecrù



J88942
26,5x180 rett. (10 1/2"x70 7/8") rect.



J88440
24x120 (9 1/2"x48")

Bslim
high tech ceramics



J88428 Bslim
15x61 (6"x24")



J88908 GRIP
24x120 (9 1/2"x48")



J88434 STRONG
15x61 (6"x24")

infinity ecrù



J88948 Infinity
26,5x180 rett. (10 1/2"x70 7/8") rect.

infinity ecrù



J88954 Infinity
24x120 (9 1/2"x48")

tendina ecrù



J88960 Tendina
24x120 (9 1/2"x48")

IN R10
B

OUT R11
C

IN R10
B

honey



J88944
26,5x180 rett. (10 1/2"x70 7/8") rect.



J88442
24x120 (9 1/2"x48")

Bslim
high tech ceramics



J88430 BSlim
15x61 (6"x24")

6,5 mm



J88910 GRIP
24x120 (9 1/2"x48")



J88436 STRONG
15x61 (6"x24")

infinity honey



J88950 Infinity
26,5x180 rett. (10 1/2"x70 7/8") rect.

infinity honey



J88956 Infinity
24x120 (9 1/2"x48")

tendina honey

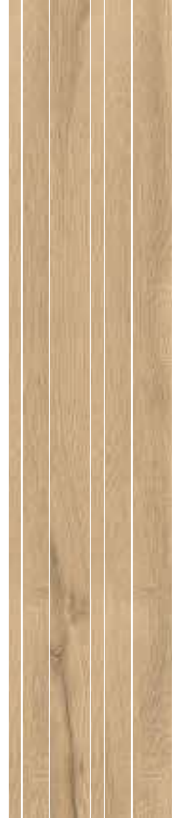

J88962 Tendina
24x120 (9 1/2"x48")

IN R10
B

OUT R11
C

IN R10
B

nut



J88946
26,5x180 rett. (10 1/2"x70 7/8") rect.



J88811
24x120 (9 1/2"x48")

Bslim
high tech ceramics



J88812 BSlim
15x61 (6"x24") 



J88813 STRONG
15x61 (6"x24")

infinity nut



J88952 Infinity
26,5x180 rett. (10 1/2"x70 7/8") rect.

infinity nut



J88958 Infinity
24x120 (9 1/2"x48")

tendina nut



J88964 Tendina
24x120 (9 1/2"x48")

ecrù sviluppo grafico 24x120 (9½"x48")



30 26,5x180

GRAFICHE DIVERSE
DIFFERENT PATTERNS
DIFFÉRENTS MOTIFS
VERSCHIEDENE MUSTER

30 24x120

GRAFICHE DIVERSE
DIFFERENT PATTERNS
DIFFÉRENTS MOTIFS
VERSCHIEDENE MUSTER

80 15x61

GRAFICHE DIVERSE
DIFFERENT PATTERNS
DIFFÉRENTS MOTIFS
VERSCHIEDENE MUSTER

decoro infinity

6 24x120

GRAFICHE DIVERSE
DIFFERENT PATTERNS
DIFFÉRENTS MOTIFS
VERSCHIEDENE MUSTER

4 PEZZI RANDOM PER SCATOLA
4 RANDOM PIECES PER BOX

6 26,5x180

GRAFICHE DIVERSE
DIFFERENT PATTERNS
DIFFÉRENTS MOTIFS
VERSCHIEDENE MUSTER

3 PEZZI RANDOM PER SCATOLA
3 RANDOM PIECES PER BOX



DARING



floor
Daring - Greige 24x120 GRIP

	Bslim							
	26,5x180 rett. (10 1/2"x70 7/8") rect.	24x120 (9 1/2"x48")	GRIP 24x120 (9 1/2"x48")	STRONG 15x61 (6"x24")	B-Slim 15x61 (6"x24")	Infinity 26,5x180 rett. (10 1/2"x70 7/8") rect.	Infinity 24x120 (9 1/2"x48")	Tendina 24x120 (9 1/2"x48")
DARK	J88941	J88439	-	-	-	J88947	J88953	J88959
GREIGE	J88943	J88441	J88909	J88435	J88429	J88949	J88955	J88961
IVORY	J88945	J88443	-	J88437	J88431	J88951	J88957	J88963
ECRÙ	J88942	J88440	J88908	J88434	J88428	J88948	J88954	J88960
HONEY	J88944	J88442	J88910	J88436	J88430	J88950	J88956	J88962
NUT	J88946	J88811	-	J88813	J88812	J88952	J88958	J88964
SPESSORE THICKNESS	9,5 mm	9,5 mm	9,5 mm	9 mm	6,5 mm	9,5 mm	9,5 mm	9,5 mm
KG/M²	21,87	20,17	20,17	17,50	13,08	21,87	20,17	-
PZ/BOX	3	4	4	13	16	3	4	4
M²/BOX	1,44	1,16	1,16	1,20	1,47	1,44	1,16	-
BOX/PALLET	36	45	45	48	48	36	45	28
M²/PALLET	51,84	52,20	52,20	57,60	70,56	51,84	52,20	-
KG/PALLET	1134	1053	1053	1008	923	1134	1053	-
€ <1 PALLET	76,50/m²	59,40/m²	59,70/m²	42,00/m²	42,00/m²	88,00/m²	68,50/m²	150,00/m²
€ >1 PALLET	66,50/m²	49,50/m²	51,90/m²	35,00/m²	35,00/m²	76,50/m²	59,50/m²	150,00/m²

	Battiscopa 8x45 (3 1/2"x18")	Gradino+Toro 33x120x4 (13"x48"x1 1/2")	Angolo+Toro Dx 33x120x4 (13"x48"x1 1/2")	Angolo+Toro Sx 33x120x4 (13"x48"x1 1/2")	Elemento a L incollato STRONG 15x61x5 (6"x24"x2")
DARK	J88609	J88614	J88619	J88624	-
GREIGE	J88611	J88616	J88621	J88626	J88631
IVORY	J88613	J88618	J88623	J88628	J88633
ECRÙ	J88610	J88615	J88620	J88625	J88630
HONEY	J88612	J88617	J88622	J88627	J88632
NUT	J88814	J88815	J88816	J88817	J88818
PZ/BOX	30	1	1	1	4
€/UM	5,40/ml	179,00 pz/pce	239,00 pz/pce	239,00 pz/pce	32,50 pz/pce

Contributo spese imballo € 10,00/pal (netto). - Packing charges € 10,00/pal (net)

<0,15%	A · HA · LA	OK	>50 N/mm²	7	5	Classe IV	Classe V	Dcof: Wet 0,50 Pendulum: Dry 53 · Wet 32	Dcof: Wet 0,57 Pendulum: Dry 49 · Wet 41	

[Back to Index](#)



BROWN



OLIVE

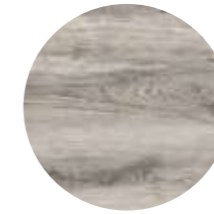

GREIGE



FOG



OAK



GRES PORCELLANATO A IMPASTO COLORATO
FULL BODY PORCELAIN STONEWARE
GRES CERAME A PATE COLOREE
DURCHGEFÄRBTES FEINSTEINZEUG

9,5 mm



30x120 rett.
12"x48" rect.



20x120 rett.
8"x48" rect.

wall
Ever - Greige 20x120
Ever - Mosaico Trapezi Greige 30x30
floor
Ever - Greige 20x120 - 30x120

brown



J86483
30x120 rett. (12"x48") rect.

J86478
20x120 rett. (8"x48") rect.



J87238 Tendina
30x120 rett. (12"x48") rect.



J86663 Spina Beige
31,4x32,7 (12²/₅"x12⁴/₅")



J86666 Mosaico Trapezi
30x30 (12"x12")

olive



J86486
30x120 rett. (12"x48") rect.

J86481
20x120 rett. (8"x48") rect.



J87242 Tendina
30x120 rett. (12"x48") rect.



J86663 Spina Beige
31,4x32,7 (12²/₅"x12⁴/₅")



J86669 Mosaico Trapezi
30x30 (12"x12")

greige



J86485
30x120 rett. (12"x48") rect.

J86480
20x120 rett. (8"x48") rect.



J87240 Tendina
30x120 rett. (12"x48") rect.



J86664 Spina Grey
31,4x32,7 (12 2/5"x12 4/5")



J86668 Mosaico Trapezi
30x30 (12"x12")

fog



J86484
30x120 rett. (12"x48") rect.

J86479
20x120 rett. (8"x48") rect.



J87239 Tendina
30x120 rett. (12"x48") rect.



J86664 Spina Grey
31,4x32,7 (12 2/5"x12 4/5")



J86667 Mosaico Trapezi
30x30 (12"x12")

oak



J86727
30x120 rett. (12"x48") rect.

J86726
20x120 rett. (8"x48") rect.



J87241 Tendina
30x120 rett. (12"x48") rect.



J86663 Spina Beige
31,4x32,7 (12 2/5"x12 4/5")



J86732 Mosaico Trapezi
30x30 (12"x12")

ethnic composizione a 6 pezzi - 6 pieces set



J86670
20x20 (8"x8")



floor
Ever - Ethnic 20x20
Ever - Brown 20x120

olive sviluppo grafico 20x120 rett. (8"x48") rett.



















20 30x120

GRAFICHE DIVERSE
DIFFERENT PATTERNS
DIFFÉRENTS MOTIFS
VERSCHIEDENE MUSTER

30 20x120

GRAFICHE DIVERSE
DIFFERENT PATTERNS
DIFFÉRENTS MOTIFS
VERSCHIEDENE MUSTER

							
	30x120 rett. (12"x48") rett.	20x120 rett. (8"x48") rett.	Tendina 30x120 rett. (12"x48") rett.	Mosaico Trapezi 30x30 (12"x12")	Spina Beige 31,4x32,7 (12 2/5"x12 4/5")	Spina Grey 31,4x32,7 (12 2/5"x12 4/5")	Ethnic 20x20 (8"x8")
 BROWN	J86483	J86478	J87238	J86666	J86663	-	J86670
 OLIVE	J86486	J86481	J87242	J86669	J86663	-	J86670
 GREIGE	J86485	J86480	J87240	J86668	-	J86664	J86670
 FOG	J86484	J86479	J87239	J86667	-	J86664	J86670
 OAK	J86727	J86726	J87241	J86732	J86663	-	J86670
SPESSORE THICKNESS	9,5 mm	9,5 mm	9,5 mm	9,5 mm	9,5 mm	9,5 mm	9,5 mm
KG/M²	22,19	22,19	22,19	22,19	22,19	22,19	22,19
PZ/BOX	3	4	4	6	4	4	1 cp/set
M²/BOX	1,08	0,96	-	-	-	-	-
BOX/PALLET	40	48	-	-	-	-	-
M²/PALLET	43,20	46,08	-	-	-	-	-
KG/PALLET	958,4	1022,4	-	-	-	-	-
€ <1 PALLET	68,70/m²	68,70/m²	140,20/m²	225,00/m²	375,00/m²	375,00/m²	119,00 cp/set
€ >1 PALLET	59,70/m²	59,70/m²	140,20/m²	225,00/m²	375,00/m²	375,00/m²	119,00 cp/set

				
	Battiscopa 8x45 (3 1/4"x18")	Gradino+Toro 33x120x4 (13"x48"x1 1/4")	Angolo+Toro Dx 33x120x4 (13"x48"x1 1/4")	Angolo+Toro Sx 33x120x4 (13"x48"x1 1/4")
 BROWN	J86702	J86598	J86603	J86608
 OLIVE	J86705	J86601	J86606	J86611
 GREIGE	J86704	J86600	J86605	J86610
 FOG	J86703	J86599	J86604	J86609
 OAK	J86733	J86728	J86729	J86730
PZ/BOX	30	2	1	1
€/UM	5,40/ml	179,00 pz/pce	239,00 pz/pce	239,00 pz/pce

Contributo spese imballo € 10,00/pal (netto). - Packing charges € 10,00/pal (net)



0,05%



A · HA · LA



OK



> 50 N/mm²



5



5



Classe V



Dcof: Wet 0,53
Pendulum:
Dry 49 · Wet 29



V4



wall
New York - Black 6x25

floor
Greenwood - Noce 7,5x45

[Back to Index](#)

GREENWOOD



GRES PORCELLANATO SMALTATO
GLAZED PORCELAIN STONEWARE
GRES CERAME EMAILLE
GLASIERTESFEINSTEINZEUG

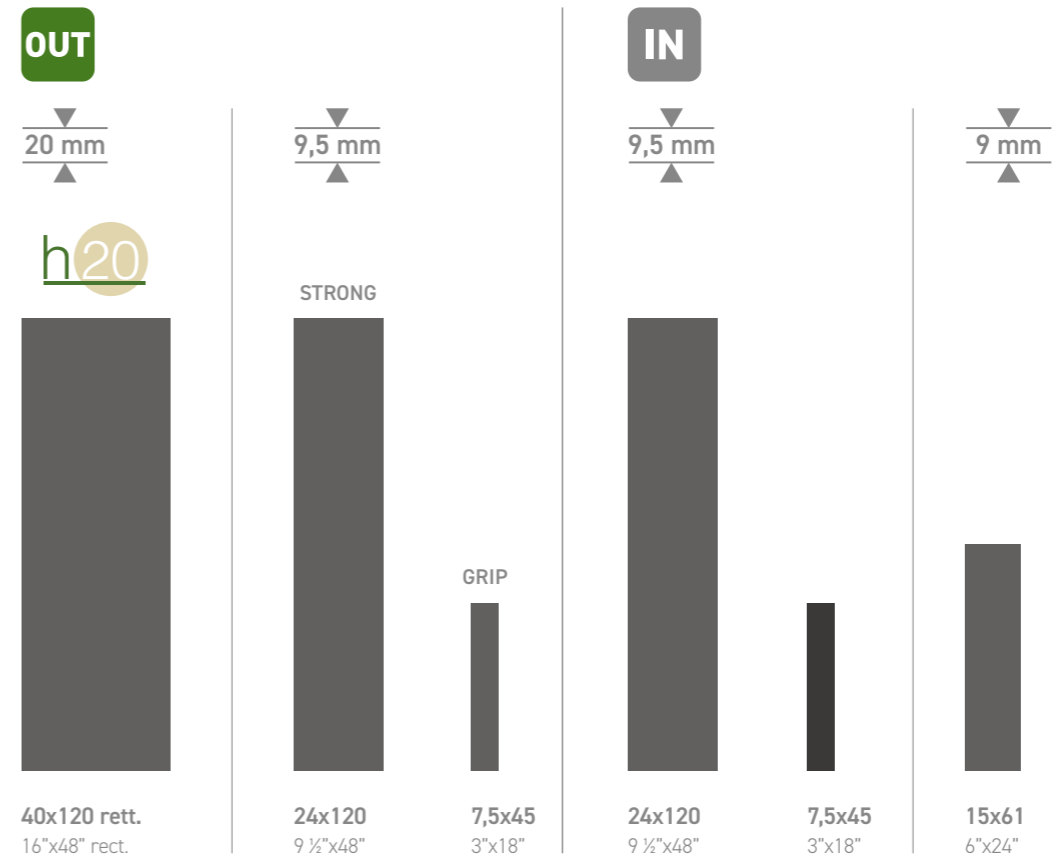

IN R10
B

OUT R11
C

IN R10
B

OUT R11
C

nero



J86329
24x120 (9 1/2"x48")



J86339
15x61 (6"x24")



J86334
7,5x45 (3"x18")



J86710 STRONG
24x120 (9 1/2"x48")

greige



J86328
24x120 (9 1/2"x48")



J86338
15x61 (6"x24")



J86333
7,5x45 (3"x18")

h20



J87066
40x120 rett. (16"x48") rect.

Disponibili pezzi speciali H20 a pag. 680



J86709 STRONG
24x120 (9 1/2"x48")

IN R10
B

OUT R11
C

IN R10
B

OUT R11
C

bianco



J86459
24x120 (9 1/2"x48")



J85040
15x61 (6"x24")



J86460
7,5x45 (3"x18")



J86707 STRONG
24x120 (9 1/2"x48")



J87530 GRIP
7,5x45 (3"x18")

beige



J86326
24x120 (9 1/2"x48")



J86336
15x61 (6"x24")



J86331
7,5x45 (3"x18")

h20



J87064
40x120 rett. (16"x48") rect.

Disponibili pezzi speciali H20 a pag. 680



J86706 STRONG
24x120 (9 1/2"x48")



J87389 GRIP
7,5x45 (3"x18")

IN R10
B

OUT R11
C

noce



J86330
24x120 (9 1/2"x48")



J86340
15x61 (6"x24")



J86335
7,5x45 (3"x18")

h20



J87067
40x120 rett. (16"x48") rect.

Disponibili pezzi speciali H20 a pag. 680

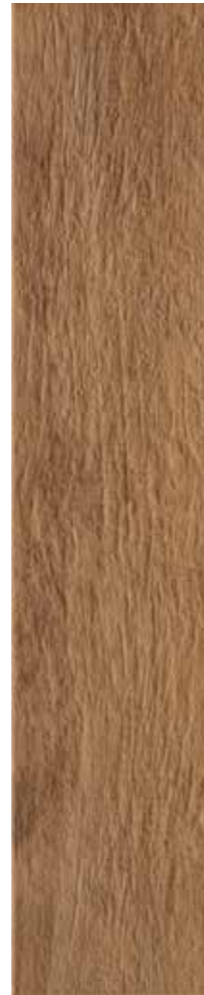

J86711 STRONG
24x120 (9 1/2"x48")



J87390 GRIP
7,5x45 (3"x18")

bruno



J86327
24x120 (9 1/2"x48")



J86337
15x61 (6"x24")



J86332
7,5x45 (3"x18")

IN R10
B

OUT R11
C

h20



J87065
40x120 rett. (16"x48") rect.

Disponibili pezzi speciali H20 a pag. 680



J86708 STRONG
24x120 (9 1/2"x48")



J87531 GRIP
7,5x45 (3"x18")

noce sviluppo grafico 24x120 (8"x48")



92 7,5x45

GRAFICHE DIVERSE
DIFFERENT PATTERNS
DIFFÉRENTS MOTIFS
VERSCHIEDENE MUSTER

46 15x61

GRAFICHE DIVERSE
DIFFERENT PATTERNS
DIFFÉRENTS MOTIFS
VERSCHIEDENE MUSTER

23 24x120

GRAFICHE DIVERSE
DIFFERENT PATTERNS
DIFFÉRENTS MOTIFS
VERSCHIEDENE MUSTER

9 40x120 h20

GRAFICHE DIVERSE
DIFFERENT PATTERNS
DIFFÉRENTS MOTIFS
VERSCHIEDENE MUSTER

	24x120 (9 1/2"x48")	STRONG 24x120 (9 1/2"x48")	h20 40x120 rett. (16"x48") rect.	15x61 (6"x24")	7,5x45 (3"x18")	GRIP 7,5x45 (3"x18")
NERO	J86329	J86710	-	J86339	J86334	-
GREIGE	J86328	J86709	J87066	J86338	J86333	-
BIANCO	J86459	J86707	-	J85040	J86460	J87530
BEIGE	J86326	J86706	J87064	J86336	J86331	J87389
NOCE	J86330	J86711	J87067	J86340	J86335	J87390
BRUNO	J86327	J86708	J87065	J86337	J86332	J87531
SPESSORE THICKNESS	9,5 mm	9,5 mm	20 mm	9 mm	9,5 mm	9,5 mm
KG/M²	20,17	20,17	46,46	17,21	20,22	20,22
PZ/BOX	4	4	1	13	26	26
M²/BOX	1,16	1,16	0,48	1,2	0,9	0,9
BOX/PALLET	45	45	48	48	42	42
M²/PALLET	52,20	52,20	23,04	57,6	37,8	37,8
KG/PALLET	1053	1053	1070,4	991,68	764,4	764,4
€ <1 PALLET	59,40/m²	59,70/m²	107,00/m²	42,00/m²	55,70/m²	59,40/m²
€ >1 PALLET	49,50/m²	51,90/m²	93,00/m²	35,00/m²	46,40/m²	49,50/m²

	Battiscopa 8x45 (3 1/2"x18")	Gradino 40x120 rett. (16"x48") rect.	Elem. a L inc. STRONG 24x120x5 (9 1/2"x48"x5")	Gradino+Toro 15x30 (6"x12")	Gradino+Toro 33x120x4 (13"x48"x1 1/2")	Angolo+Toro Dx 33x120x4 (13"x48"x1 1/2")	Angolo+Toro Sx 33x120x4 (13"x48"x1 1/2")
NERO	J86467	-	J86923	J87623	J86497	J86503	J86509
GREIGE	J86466	J87284	J86922	J87622	J86496	J86502	J86508
BIANCO	J86464	-	J86920	J87620	J86494	J86500	J86506
BEIGE	J86463	J87282	J86919	J87619	J86493	J86499	J86505
NOCE	J86468	J87285	J86924	J87624	J86498	J86504	J86510
BRUNO	J86465	J87283	J86921	J87621	J86495	J86501	J86507
PZ/BOX	30	1	2	8	1	1	1
€ /UM	5,40/ml	139,00 pz/pce	65,10 pz/pce	21,40 pz/pce	179,00 pz/pce	239,00 pz/pce	239,00 pz/pce

Contributo spese imballo € 10,00/pal (netto). - Packing charges € 10,00/pal (net)

0,1%
 A · HA · LA
 OK
 50,1 N/mm²
 6
 5
 Classe IV
 Classe V
 R10 B Dcof: Wet 0,44 Pendulum: Dry 45 · Wet 32
 R11 C Dcof: Wet 0,71 Pendulum: Dry 52 · Wet 43
 R11 C h20 Dcof: Wet 0,77 Pendulum: Dry 62 · Wet 48
 V3
 Noce, Bruno Nero, Greige
 Bianco Beige



floor
Hard & Soft - Soft Ash 15x100

[Back to Index](#)

HARD & SOFT

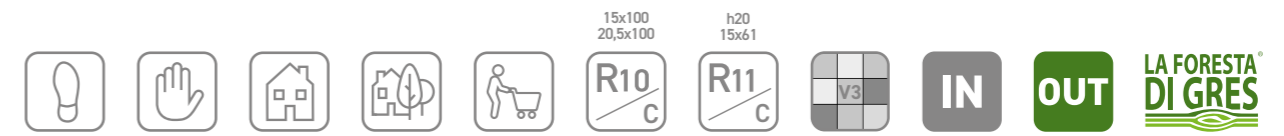

GRES PORCELLANATO SMALTATO
GLAZED PORCELAIN STONEWARE
GRES CERAME EMAILLE
GLASIERTESFEINSTEINZEUG

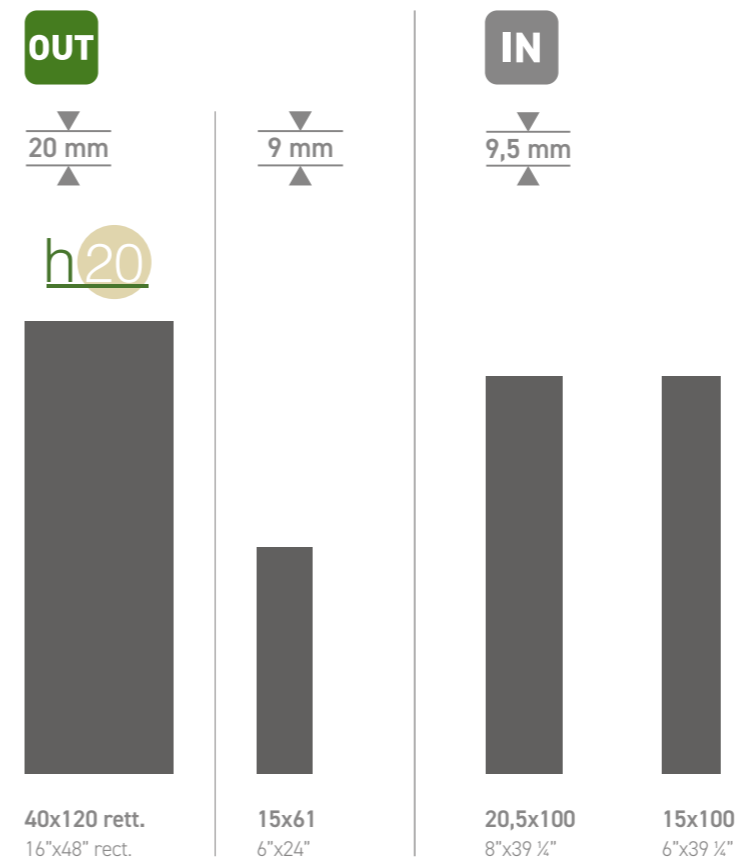

IN R10
C

soft ash



J87958 Multiformato
35,5x100 (14"x39 1/4")

J87757
20,5x100 (8"x39 1/4")

J85804
15x100 (6"x39 1/4")

OUT R11
C

hard ash



J87361
40x120 rett. (16"x48") rect.



J86734
15x61 (6"x24")

Disponibili pezzi speciali H20 a pag. 680

IN R10
C

soft greige



J87961 Multiformato
35,5x100 (14"x39 1/4")

J87760
20,5x100 (8"x39 1/4")

J85807
15x100 (6"x39 1/4")

OUT R11
C

hard greige



J87363
40x120 rett. (16"x48") rect.



J86735
15x61 (6"x24")

Disponibili pezzi speciali H20 a pag. 680



NUOVO IMBALLO: DUE FORMATI NELLA STESSA SCATOLA (20,5x100 + 15x100)

- 3 pezzi 20,5x100 + 3 pezzi 15x100;
- Garanzia di avere il medesimo tono per entrambi i formati;
- Facilità di gestione: un solo articolo da ordinare;
- Eliminazione delle rimanenze di magazzino.

NEW PACKAGING: TWO SIZES IN THE SAME BOX (20.5X100 + 15X100)

- 3 pieces 20.5x100 + 3 pieces 15x100;
- Guarantee to have the same tone for both formats;
- Ease of management: only one item to order;
- Elimination of warehouse inventory.

NOUVEL EMBALLAGE: DEUX TAILLES DANS LA MÊME BOÎTE (20.5X100 + 15X100)

- 3 pièces 20.5x100 + 3 pièces 15x100;
- Garantie d'avoir le même ton pour les deux formats;
- Facilité de gestion: un seul article à commander;
- Élimination des stocks d'entrepôt.

NEUE VERPACKUNG: ZWEI GRÖSSEN IN DER GLEICHEN BOX (20.5X100 + 15X100)

- 3 Stück 20,5x100 + 3 Stück 15x100;
- Stellen Sie sicher, dass beide Formate den gleichen Ton haben;
- Einfache Verwaltung: nur ein Artikel zu bestellen;
- Eliminierung von Lagerbeständen.

IN R10
C

OUT R11
C

soft white



J87963 Multiformato
35,5x100 (14"x39 1/4")

J87762
20,5x100 (8"x39 1/4")

J86416
15x100 (6"x39 1/4")

hard grey



J85520
15x61 (6"x24")

IN R10
C

OUT R11
C

soft cream



J87960 Multiformato
35,5x100 (14"x39 1/4")

J87759
20,5x100 (8"x39 1/4")

J85806
15x100 (6"x39 1/4")

hard cream



J85519
15x61 (6"x24")



NUOVO IMBALLO: DUE FORMATI NELLA STESSA SCATOLA (20,5x100 + 15x100)

- 3 pezzi 20,5x100 + 3 pezzi 15x100;
- Garanzia di avere il medesimo tono per entrambi i formati;
- Facilità di gestione: un solo articolo da ordinare;
- Eliminazione delle rimanenze di magazzino.

NEW PACKAGING: TWO SIZES IN THE SAME BOX (20.5X100 + 15X100)

- 3 pieces 20.5x100 + 3 pieces 15x100;
- Guarantee to have the same tone for both formats;
- Ease of management: only one item to order;
- Elimination of warehouse inventories.

NOUVEL EMBALLAGE: DEUX TAILLES DANS LA MÊME BOÎTE (20.5X100 + 15X100)

- 3 pièces 20.5x100 + 3 pièces 15x100;
- Garantie d'avoir le même ton pour les deux formats;
- Facilité de gestion: un seul article à commander;
- Élimination des stocks d'entrepôt.

NEUE VERPACKUNG: ZWEI GRÖSSEN IN DER GLEICHEN BOX (20.5X100 + 15X100)

- 3 Stück 20,5x100 + 3 Stück 15x100;
- Stellen Sie sicher, dass beide Formate den gleichen Ton haben;
- Einfache Verwaltung: nur ein Artikel zu bestellen;
- Eliminierung von Lagerbeständen.

IN R10
C

soft brown



J87959 Multiformato
35,5x100 (14"x39 1/4")

J87758
20,5x100 (8"x39 1/4")

J85805
15x100 (6"x39 1/4")

OUT R11
C

hard brown



J87362
40x120 rett. (16"x48") rect.



J85518
15x61 (6"x24")

Disponibili pezzi speciali H20 a pag. 680

IN R10
C

soft nut



J87962 Multiformato
35,5x100 (14"x39 1/4")

J87761
20,5x100 (8"x39 1/4")

J85808
15x100 (6"x39 1/4")

OUT R11
C

hard nut



J87364
40x120 rett. (16"x48") rect.



Disponibili pezzi speciali H20 a pag. 680



NUOVO IMBALLO: DUE FORMATI NELLA STESSA SCATOLA (20,5x100 + 15x100)

- 3 pezzi 20,5x100 + 3 pezzi 15x100;
- Garanzia di avere il medesimo tono per entrambi i formati;
- Facilità di gestione: un solo articolo da ordinare;
- Eliminazione delle rimanenze di magazzino.

NEW PACKAGING: TWO SIZES IN THE SAME BOX (20.5X100 + 15X100)

- 3 pieces 20.5x100 + 3 pieces 15x100;
- Guarantee to have the same tone for both formats;
- Ease of management: only one item to order;
- Elimination of warehouse inventory.

NOUVEL EMBALLAGE: DEUX TAILLES DANS LA MÊME BOÎTE (20.5X100 + 15X100)

- 3 pièces 20.5x100 + 3 pièces 15x100;
- Garantie d'avoir le même ton pour les deux formats;
- Facilité de gestion: un seul article à commander;
- Élimination des stocks d'entrepôt.

NEUE VERPACKUNG: ZWEI GRÖSSEN IN DER GLEICHEN BOX (20.5X100 + 15X100)

- 3 Stück 20,5x100 + 3 Stück 15x100;
- Stellen Sie sicher, dass beide Formate den gleichen Ton haben;
- Einfache Verwaltung: nur ein Artikel zu bestellen;
- Eliminierung von Lagerbeständen.

greige sviluppo grafico 15x100 (6"x39 1/4")



24 15x100

GRAFICHE DIVERSE
DIFFERENT PATTERNS
DIFFÉRENTS MOTIFS
VERSCHIEDENE MUSTER

24 20,5x100

GRAFICHE DIVERSE
DIFFERENT PATTERNS
DIFFÉRENTS MOTIFS
VERSCHIEDENE MUSTER

48 15x61

GRAFICHE DIVERSE
DIFFERENT PATTERNS
DIFFÉRENTS MOTIFS
VERSCHIEDENE MUSTER

10 40x120 h20

GRAFICHE DIVERSE
DIFFERENT PATTERNS
DIFFÉRENTS MOTIFS
VERSCHIEDENE MUSTER

	Multiformato 35,5x100 (14"x39 1/4")	20,5x100 (8"x39 1/4")	15x100 (6"x39 1/4")	Battiscopa 8x45 (3 1/4"x18")	Gradino+Toro 100x15x4 (39 1/2"x6"x1 1/2")	Gradino+Toro 30x100x4 (12"x39 1/2"x1 1/2")	Angolo+Toro Dx 15x100x4 (6"x39 1/2"x1 1/2")	Angolo+Toro Sx 15x100x4 (6"x39 1/2"x1 1/2")
SOFT ASH	J87958	J87757	J85804	J85948	J85827	J85812	J85817	J85822
SOFT GREIGE	J87961	J87760	J85807	J85949	J85830	J85815	J85820	J85825
SOFT WHITE	J87963	J87762	J86416	J85033	J86420	J86417	J86418	J86419
SOFT CREAM	J87960	J87759	J85806	J85847	J85829	J85814	J85819	J85824
SOFT BROWN	J87959	J87758	J85805	J85846	J85828	J85813	J85818	J85823
SOFT NUT	J87962	J87761	J85808	J85950	J85831	J85816	J85821	J85826
SPESSORE THICKNESS	9,5 mm	9,5 mm	9,5 mm	9 mm	9,5 mm	9,5 mm	9,5 mm	9,5 mm
KG/M²	19,81	21,46	19,91	-	-	-	-	-
PZ/BOX	3	6	8	30	2	1	2	2
M²/BOX	1,07	1,23	1,23	-	-	-	-	-
BOX/PALLET	36	36	42	42	-	-	-	-
M²/PALLET	38,52	44,28	51,66	-	-	-	-	-
KG/PALLET	763,2	950,4	1028,6	-	-	-	-	-
€ <1 PALLET	60,00/m²	55,80/m²	55,80/m²	5,40/ml	50,00 pz/pce	150,00 pz/pce	195,00 pz/pce	195,00 pz/pce
€ >1 PALLET	50,00/m²	46,50/m²	46,50/m²	5,40/ml	50,00 pz/pce	150,00 pz/pce	195,00 pz/pce	195,00 pz/pce

	15x61 (6"x24")	h20 40x120 rett. (16"x48") rect.	Battiscopa 8x45 (3 1/4"x18")	Gradino 40x120 rett. (16"x48") rect.	Elemento a L incollato 15x61x5 (6"x24"x2")	Gradino+Toro 15x30,5x5 (6"x12"x2")	Angolo+Toro Dx 15x30,5x5 (6"x12"x2")	Angolo+Toro Sx 15x30,5x5 (6"x12"x2")
HARD ASH	J86734	J87361	J85948	J87365	J86840	J86846	J86842	J86844
HARD GREIGE	J86735	J87363	J85949	J87367	J86841	J86847	J86843	J86845
HARD GREY	J85520	-	J85848	-	J85761	J85845	J85839	J85842
HARD CREAM	J85519	-	J85847	-	J85760	J85844	J85838	J85841
HARD BROWN	J85518	J87362	J85846	J87366	J85759	J85843	J85837	J85840
HARD NUT	-	J87364	-	J87368	-	-	-	-
SPESSORE THICKNESS	9 mm	20 mm	9 mm	20 mm	9 mm	9 mm	9 mm	9 mm
KG/M²	17,40	46,46	-	-	-	-	-	-
PZ/BOX	13	1	30	1	4	8	2	2
M²/BOX	1,2	0,48	-	-	-	-	-	-
BOX/PALLET	48	48	42	-	-	-	-	-
M²/PALLET	57,6	23,04	-	-	-	-	-	-
KG/PALLET	1002,72	1070,4	-	-	-	-	-	-
€ <1 PALLET	42,00/m²	107,00/m²	5,40/ml	139,00 pz/pce	32,50 pz/pce	21,40 pz/pce	52,00 pz/pce	52,00 pz/pce
€ >1 PALLET	35,00/m²	93,00/m²	5,40/ml	139,00 pz/pce	32,50 pz/pce	21,40 pz/pce	52,00 pz/pce	52,00 pz/pce



< 0,15%



A • HA • LA



OK



42,1 N/mm²
56,1 N/mm²



8 (15x61)
6 (15x100)



5



Classe V



15x100
20,5x100
Dcof: Wet 0,60
Pendulum:
Dry 53 • Wet 28



15x61
Dcof: Wet 0,60
Pendulum:
Dry 49 • Wet 41



h20
Dcof: Wet 0,90
Pendulum:
Dry 53 • Wet 44



INWOOD

Back to Index



BLACK

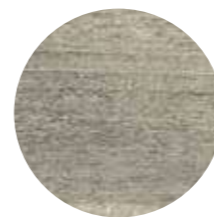

DARK GREY



BLUE

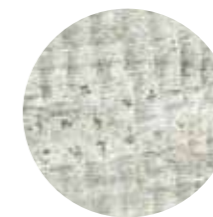

SKY



IVORY



CARAMEL



GRES PORCELLANATO SMALTATO
GLAZED PORCELAIN STONEWARE
GRES CERAME EMAILLE
GLASIERTESFEINSTEINZEUG

Coordinato con:
Coordinated with:

INWOOD 3D
SEZ. 3D
PG. 111

9,5 mm



15x100
6"x39 1/2"



7,5x45
3"x18"

wall
Inwood - Dark Grey 7,5x45

floor
Inwood - Black 15x100



black



J87081
15x100 (6"x39 1/4")



J87087
7,5x45 (3"x18")



J87093 Mosaico
30x30 (12"x12")



J87199 Mosaico Spina
32x28,5 (12 1/2"x11 1/8")

dark grey



J87084
15x100 (6"x39 1/4")



J87090
7,5x45 (3"x18")

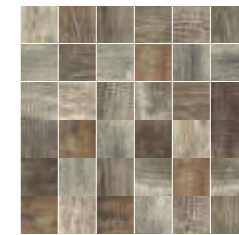

J87096 Mosaico
30x30 (12"x12")



J87202 Mosaico Spina
32x28,5 (12 1/2"x11 1/8")



blue



J87082
15x100 (6"x39 1/4")



J87088
7,5x45 (3"x18")



J87094 Mosaico
30x30 (12"x12")



J87200 Mosaico Spina
32x28,5 (12 1/2"x11 1/8")

sky



J87086
15x100 (6"x39 1/4")



J87092
7,5x45 (3"x18")

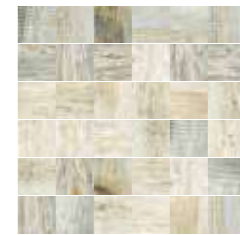

J87098 Mosaico
30x30 (12"x12")



J87204 Mosaico Spina
32x28,5 (12 1/2"x11 1/8")



ivory



J87085
15x100 (6"x39 1/4")



J87091
7,5x45 (3"x18")



J87097 Mosaico
30x30 (12"x12")



J87203 Mosaico Spina
32x28,5 (12 1/2"x11 1/8")

caramel



J87083
15x100 (6"x39 1/4")



J87089
7,5x45 (3"x18")

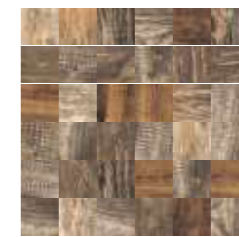

J87095 Mosaico
30x30 (12"x12")



J87201 Mosaico Spina
32x28,5 (12 1/2"x11 1/8")

dark grey sviluppo grafico 15x100 (6"x39 1/4")



35 15x100



















GRAFICHE DIVERSE

DIFFERENT PATTERNS
DIFFÉRENTS MOTIFS
VERSCHIEDENE MUSTER

140 7,5x45

GRAFICHE DIVERSE

DIFFERENT PATTERNS
DIFFÉRENTS MOTIFS
VERSCHIEDENE MUSTER

	15x100 (6"x39 1/4")	7,5x45 (3"x18")	 Mosaico 30x30 (12"x12")	 Mosaico Spina 32x28,5 (12 1/2"x11 1/8")	
 BLACK	J87081	J87087	J87093	J87199	
 DARK GREY	J87084	J87090	J87096	J87202	
 BLUE	J87082	J87088	J87094	J87200	
 SKY	J87086	J87092	J87098	J87204	
 IVORY	J87085	J87091	J87097	J87203	
 CAMEL	J87083	J87089	J87095	J87201	
SPESSORE THICKNESS	9,5 mm	9,5 mm	9,5 mm	9,5 mm	
KG/M²	20,13	20,14	20,13	20,13	
PZ/BOX	8	26	6	6	
M²/BOX	1,23	0,9	-	-	
BOX/PALLET	42	42	-	-	
M²/PALLET	51,66	37,8	-	-	
KG/PALLET	1039,9	731,5	-	-	
€ <1 PALLET	55,80/m²	55,80/m²	122,20/m²	154,50/m²	
€ >1 PALLET	46,50/m²	46,50/m²	122,20/m²	154,50/m²	
					
	Battiscopa 7,5x100 (3"x39 1/4")	Gradino+Toro 100x15x4 (39 1/4"x6"x1 3/4")	Gradino+Toro 30x100x4 (12"x39 1/4"x1 3/4")	Angolo+Toro Dx 15x100x4 (6"x39 1/4"x1 3/4")	Angolo+Toro Sx 15x100x4 (6"x39 1/4"x1 3/4")
 BLACK	J87099	J87123	J87105	J87111	J87117
 DARK GREY	J87102	J87126	J87108	J87114	J87120
 BLUE	J87100	J87124	J87106	J87112	J87118
 SKY	J87104	J87128	J87110	J87116	J87122
 IVORY	J87103	J87127	J87109	J87115	J87121
 CAMEL	J87101	J87125	J87107	J87113	J87119
PZ/BOX	6	2	1	2	2
€ /UM	13,30 pz/pce	50,00 pz/pce	150,00 pz/pce	195,00 pz/pce	195,00 pz/pce

Contributo spese imballo € 10,00/pal (netto). - Packing charges € 10,00/pal (net)

 0,1%
  A • HA • LA
  OK
  52,8 N/mm²
  8
  5
  Caramel, Blue, Dark Grey, Black
  Sky, Ivory
  R10 A
  V4

Classe IV Classe V Dcof: Wet 0,54 Pendulum: Dry 58 • Wet 21



floor
Living - Tortora 7,5x45

LIVING

[Back to Index](#)



NERO



CENERE



TORTORA



BIANCO

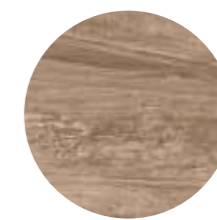

MARRONE

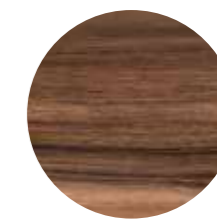

NOCE



GRES PORCELLANATO SMALTATO
GLAZED PORCELAIN STONEWARE
GRES CERAME EMAILLE
GLASIERTESFEINSTEINZEUG

9,5 mm



20,5x100
8"x39 1/2"



15x100
6"x39 1/2"



7,5x45
3"x18"

9 mm



15x61
6"x24"



nero



J86351
7,5x45 (3"x18")

cenere



J87954 Multiformato
35,5x100 (14"x39 1/4")

J87764
20,5x100 (8"x39 1/4")

J86019
15x100 (6"x39 1/4")

J86151
15x61 (6"x24")

J86356
7,5x45 (3"x18")



NUOVO IMBALLO: DUE FORMATI NELLA STESSA SCATOLA (20,5x100 + 15x100)

- 3 pezzi 20,5x100 + 3 pezzi 15x100;
- Garanzia di avere il medesimo tono per entrambi i formati;
- Facilità di gestione: un solo articolo da ordinare;
- Eliminazione delle rimanenze di magazzino.

NEW PACKAGING: TWO SIZES IN THE SAME BOX (20.5X100 + 15X100)

- 3 pieces 20,5x100 + 3 pieces 15x100;
- Guarantee to have the same tone for both formats;
- Ease of management: only one item to order;
- Elimination of warehouse inventory.

NOUVEL EMBALLAGE: DEUX TAILLES DANS LA MÊME BOÎTE (20.5X100 + 15X100)

- 3 pièces 20,5x100 + 3 pièces 15x100;
- Garantie d'avoir le même ton pour les deux formats;
- Facilité de gestion: un seul article à commander;
- Élimination des stocks d'entrepôt.

NEUE VERPACKUNG: ZWEI GRÖSSEN IN DER GLEICHEN BOX (20.5X100 + 15X100)

- 3 Stück 20,5x100 + 3 Stück 15x100;
- Stellen Sie sicher, dass beide Formate den gleichen Ton haben;
- Einfache Verwaltung: nur ein Artikel zu bestellen;
- Eliminierung von Lagerbeständen.



tortora



J87957 Multiformato
35,5x100 (14"x39 1/4")

J87767
20,5x100 (8"x39 1/4")

J86023
15x100 (6"x39 1/4")

J86155
15x61 (6"x24")

J86348
7,5x45 (3"x18")



bianco



J87953 Multiformato
35,5x100 (14"x39 1/4")

J87763
20,5x100 (8"x39 1/4")

J86020
15x100 (6"x39 1/4")

J86152
15x61 (6"x24")

J86347
7,5x45 (3"x18")



NUOVO IMBALLO: DUE FORMATI NELLA STESSA SCATOLA (20,5x100 + 15x100)

- 3 pezzi 20,5x100 + 3 pezzi 15x100;
- Garanzia di avere il medesimo tono per entrambi i formati;
- Facilità di gestione: un solo articolo da ordinare;
- Eliminazione delle rimanenze di magazzino.

NEW PACKAGING: TWO SIZES IN THE SAME BOX (20.5X100 + 15X100)

- 3 pieces 20,5x100 + 3 pieces 15x100;
- Guarantee to have the same tone for both formats;
- Ease of management: only one item to order;
- Elimination of warehouse inventories.

NOUVEL EMBALLAGE: DEUX TAILLES DANS LA MÊME BOÎTE (20.5X100 + 15X100)

- 3 pièces 20,5x100 + 3 pièces 15x100;
- Garantie d'avoir le même ton pour les deux formats;
- Facilité de gestion: un seul article à commander;
- Élimination des stocks d'entrepôt.

NEUE VERPACKUNG: ZWEI GRÖSSEN IN DER GLEICHEN BOX (20.5X100 + 15X100)

- 3 Stück 20,5x100 + 3 Stück 15x100;
- Stellen Sie sicher, dass beide Formate den gleichen Ton haben;
- Einfache Verwaltung: nur ein Artikel zu bestellen;
- Eliminierung von Lagerbeständen.



marrone

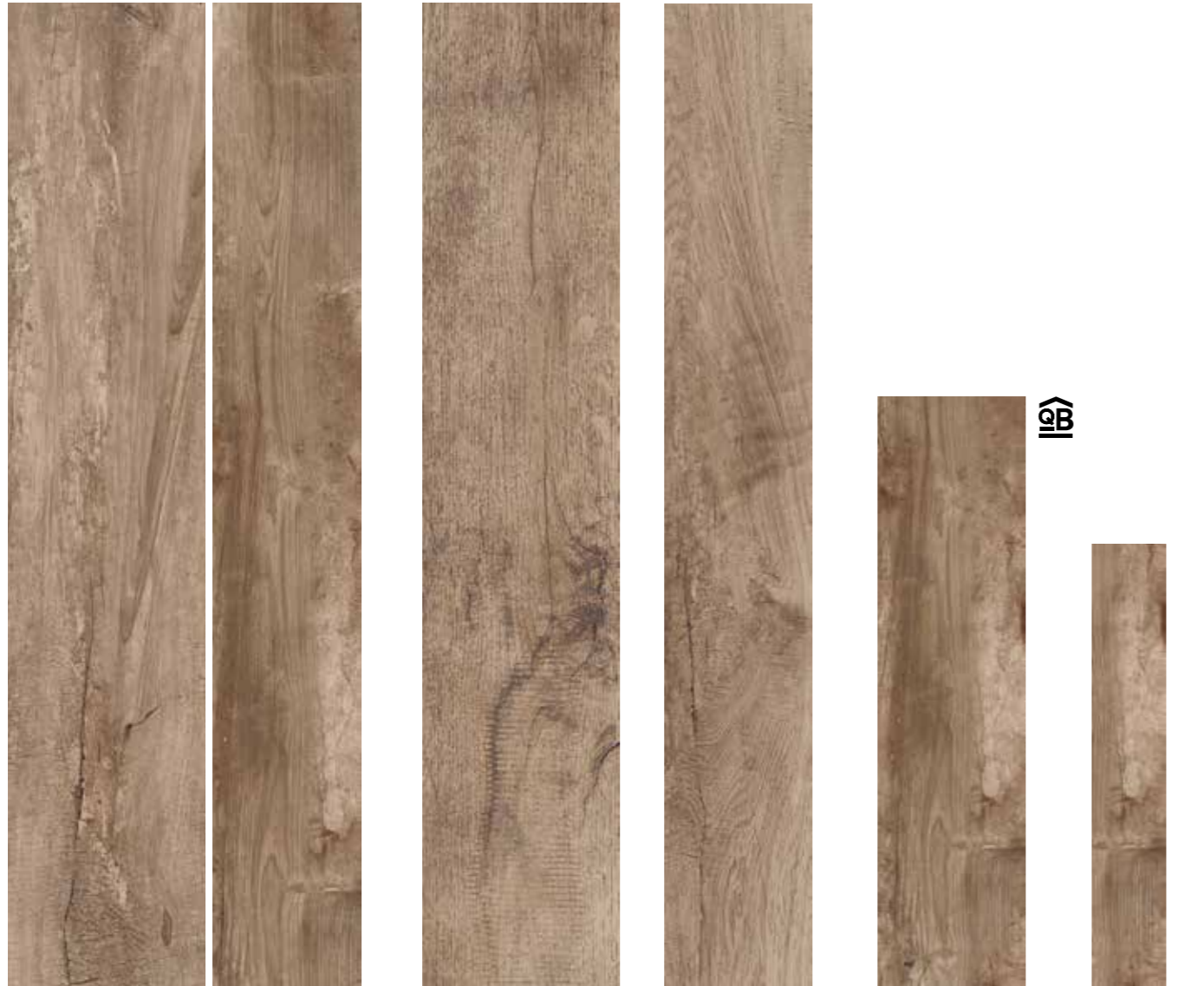

J87955 Multiformato 35,5x100 (14"x39 1/4")
J87765 20,5x100 (8"x39 1/4")
J86021 15x100 (6"x39 1/4")
J86153 15x61 (6"x24")
J86349 7,5x45 (3"x18")

IB



NUOVO IMBALLO: DUE FORMATI NELLA STESSA SCATOLA (20,5x100 + 15x100)

- 3 pezzi 20,5x100 + 3 pezzi 15x100;
- Garanzia di avere il medesimo tono per entrambi i formati;
- Facilità di gestione: un solo articolo da ordinare;
- Eliminazione delle rimanenze di magazzino.

NEW PACKAGING: TWO SIZES IN THE SAME BOX (20.5X100 + 15X100)

- 3 pieces 20,5x100 + 3 pieces 15x100;
- Guarantee to have the same tone for both formats;
- Ease of management: only one item to order;
- Elimination of warehouse inventory.



noce



J87956 Multiformato 35,5x100 (14"x39 1/4")
J87766 20,5x100 (8"x39 1/4")
J86022 15x100 (6"x39 1/4")
J86154 15x61 (6"x24")
J86350 7,5x45 (3"x18")

NOUVEL EMBALLAGE: DEUX TAILLES DANS LA MÊME BOÎTE (20.5X100 + 15X100)

- 3 pièces 20,5x100 + 3 pièces 15x100;
- Garantie d'avoir le même ton pour les deux formats;
- Facilité de gestion: un seul article à commander;
- Élimination des stocks d'entrepôt.

NEUE VERPACKUNG: ZWEI GRÖSSEN IN DER GLEICHEN BOX (20.5X100 + 15X100)

- 3 Stück 20,5x100 + 3 Stück 15x100;
- Stellen Sie sicher, dass beide Formate den gleichen Ton haben;
- Einfache Verwaltung: nur ein Artikel zu bestellen;
- Eliminierung von Lagerbeständen.

marrone sviluppo grafico 15x100 (6"x39 1/2")



24 15x100

GRAFICHE DIVERSE
DIFFERENT PATTERNS
DIFFÉRENTS MOTIFS
VERSCHIEDENE MUSTER

24 20,5x100

GRAFICHE DIVERSE
DIFFERENT PATTERNS
DIFFÉRENTS MOTIFS
VERSCHIEDENE MUSTER

48 15x61

GRAFICHE DIVERSE
DIFFERENT PATTERNS
DIFFÉRENTS MOTIFS
VERSCHIEDENE MUSTER

90 7,5x45

GRAFICHE DIVERSE
DIFFERENT PATTERNS
DIFFÉRENTS MOTIFS
VERSCHIEDENE MUSTER

< 0,15%
 A • HA • LA
 OK
 48,5 N/mm²
 6
 5
 Noce, Nero
 4
 5
 Cenero, Tortora Bianco, Marrone
 R9/B
 R10/B
 7,5x45
 V3

Dcof: Wet 0,66 Pendulum: Dry 40 • Wet 26
 Dcof: Wet 0,71 Pendulum: Dry 42 • Wet 25

CENERE	J87954	J87764	J86019	J85948	J85009	J84994	J84999	J85004
TORTORA	J87957	J87767	J86023	J85949	J85012	J84997	J85002	J85007
BIANCO	J87953	J87763	J86020	J85033	J85008	J84993	J84998	J85003
MARRONE	J87955	J87765	J86021	J85846	J85010	J84995	J85000	J85005
NOCE	J87956	J87766	J86022	J85950	J85011	J84996	J85001	J85006
SPESSORE THICKNESS	9,5 mm	9,5 mm	9,5 mm	9 mm	9,5 mm	9,5 mm	9,5 mm	9,5 mm
KG/M²	19,81	21,46	21,46	16,84	19,91	19,91	19,91	19,91
PZ/BOX	3	6	8	30	2	1	2	2
M²/BOX	1,07	1,23	1,23	13,5 m	-	-	-	-
BOX/PALLET	36	36	42	42	-	-	-	-
M²/PALLET	38,52	44,28	51,66	567 m	-	-	-	-
KG/PALLET	763,2	950,4	1108	722	-	-	-	-
€ <1 PALLET	60,00/m²	55,80/m²	55,80/m²	5,40/ml	50,00 pz/pce	150,00 pz/pce	195,00 pz/pce	195,00 pz/pce
€ >1 PALLET	50,00/m²	46,50/m²	46,50/m²	5,40/ml	50,00 pz/pce	150,00 pz/pce	195,00 pz/pce	195,00 pz/pce

NERO	-	J86351	-	-	-	-
CENERE	J86151	J86356	J85948	J85014	J85019	J85024
TORTORA	J86155	J86348	J85949	J85017	J85022	J85027
BIANCO	J86152	J86347	J85033	J85013	J85018	J85023
MARRONE	J86153	J86349	J85846	J85015	J85020	J85025
NOCE	J86154	J86350	J85950	J85016	J85021	J85026
SPESSORE THICKNESS	9 mm	9,5 mm	9 mm	9 mm	9 mm	9 mm
KG/M²	19,34	20,22	16,84	16,84	16,84	16,84
PZ/BOX	13	26	30	8	2	2
M²/BOX	1,2	0,9	13,5 m	-	-	-
BOX/PALLET	48	42	42	-	-	-
M²/PALLET	57,6	37,8	567 m	-	-	-
KG/PALLET	1113,6	764,3	722	-	-	-
€ <1 PALLET	42,00/m²	55,70/m²	5,40/ml	21,40 pz/pce	52,00 pz/pce	52,00 pz/pce
€ >1 PALLET	35,00/m²	46,40/m²	5,40/ml	21,40 pz/pce	52,00 pz/pce	52,00 pz/pce

Contributo spese imballo € 10,00/pal (netto). - Packing charges € 10,00/pal (net)



floor
Renaissance - Azul 24x150

[Back to Index](#)

RENAISSANCE



AZUL



GREEN

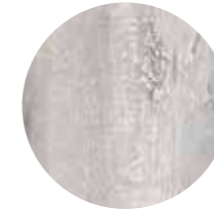

GREY



WHITE



BEIGE



NUT



GRES PORCELLANATO SMALTATO
GLAZED PORCELAIN STONWARE
GRES CERAME EMAILLE
GLASIERTESFEINSTEINZEUG

8,5 mm



24x150
9 1/2"x59"



ASOO
SHOP

wall
Loft - White 80x80

floor
Renaissance - Green 24x150

azul



J89458
24x150 (9 1/2"x59")

green



J89460
24x150 (9 1/2"x59")



grey



J89461
24x150 (9 1/2"x59")

white



J89463
24x150 (9 1/2"x59")



J89682 Mosaico a Spina
32x28,5 (12 1/2"x11 1/5")



J89684 Mosaico a Spina
32x28,5 (12 1/2"x11 1/5")



J89685 Mosaico a Spina
32x28,5 (12 1/2"x11 1/5")

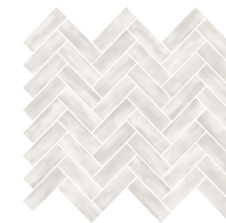

J89687 Mosaico a Spina
32x28,5 (12 1/2"x11 1/5")

beige



J89459
24x150 (9 1/2"x59")



J89683 Mosaico a Spina
32x28,5 (12 1/2"x11 1/8")

nut



J89462
24x150 (9 1/2"x59")



J89686 Mosaico a Spina
32x28,5 (12 1/2"x11 1/8")



floor
Renaissance - Nut Mosaico a Spina 32x28,5

nut sviluppo grafico 24x150 (9 1/2"x59")

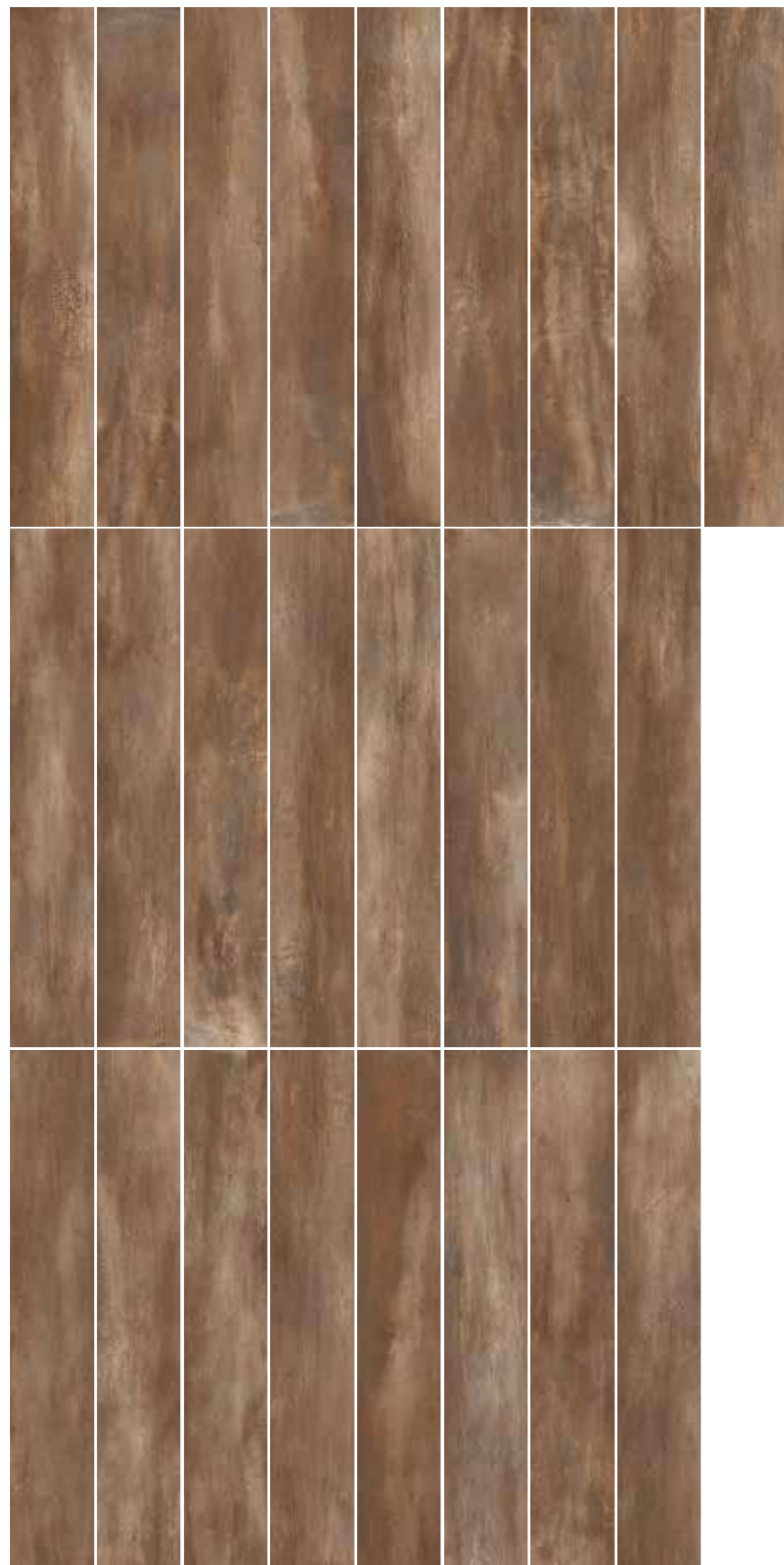

25 24x150

GRAFICHE DIVERSE

DIFFERENT PATTERNS
DIFFÉRENTS MOTIFS
VERSCHIEDENE MUSTER

	24x150 (9 1/2"x59")	Mosaico a Spina 32x28,5 (12 1/2"x11 1/8")	Battiscopa 6x150 (9 1/2"x59")
AZUL	J89458	J89682	J89688
GREEN	J89460	J89684	J89690
GREY	J89461	J89685	J89691
WHITE	J89463	J89687	J89693
BEIGE	J89459	J89683	J89689
NUT	J89462	J89686	J89692
SPESSORE THICKNESS	8,5 mm	8,5 mm	8,5 mm
KG/M²	19,21	20,00	-
PZ/BOX	3	6	6
M²/BOX	1,08	1,81	-
BOX/PALLET	36	60	-
M²/PALLET	38,88	33	-
KG/PALLET	747	660	-
€ <1 PALLET	59,30/m²	154,50/m²	19,90 pz/pce
€ >1 PALLET	51,50/m²	154,50/m²	19,90 pz/pce

Contributo spese imballo € 10,00/pal (netto). - Packing charges € 10,00/pal (net)



<0,1%



A · HA · LA



OK



>45 N/mm²



7



5

Azul, Green,
Nut



Classe IV

Beige, Grey,
White



Classe V



Dcof: >0,42

Pendulum:
Dry > 36; Wet 25 < x < 35



V2



floor
Tabula - Fog 15x100

[Back to Index](#)

TABULA

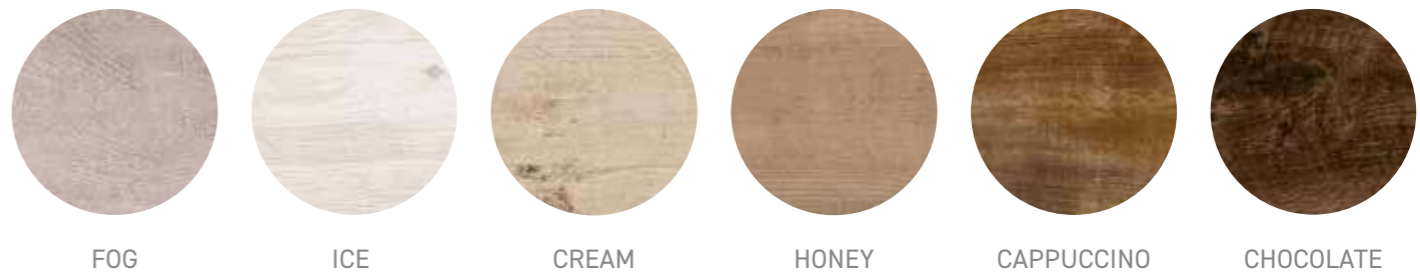

GRES PORCELLANATO SMALTATO
GLAZED PORCELAIN STONWARE
GRES CERAME EMAILLE
GLASIERTESFEINSTEINZEUG

15x100 e 15x61 DA PRESSA
6"x39 1/2" & 6"x24" MOULDED

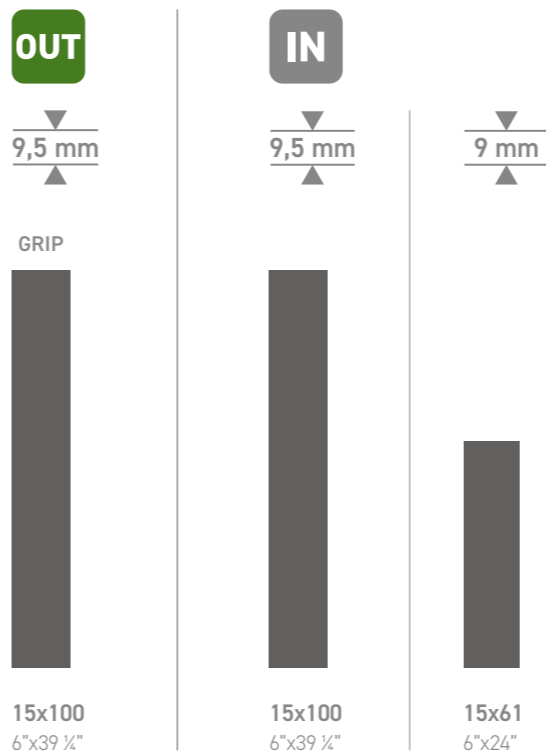

IN R10
A

fog



J84616
15x100 (6"x39 1/4")



J84576
15x61 (6"x24")

OUT GRIP
R11
B



J85347 GRIP
15x100 (6"x39 1/4")

IN R10
A

ice



J84618
15x100 (6"x39 1/4")



J84577
15x61 (6"x24")

IN R10
A

cream



J84615
15x100 (6"x39 1/4")



J84312
15x61 (6"x24")

IN R10
A

honey



J84617
15x100 (6"x39 1/4")



J84311
15x61 (6"x24")

OUT GRIP
R11
B



J85348 GRIP
15x100 (6"x39 1/4")

IN R10
A

cappuccino



J84613
15x100 (6"x39 1/4")



J84310
15x61 (6"x24")

OUT GRIP
R11
B

chocolate



J85344 GRIP
15x100 (6"x39 1/4")



J84614
15x100 (6"x39 1/4")



J84309
15x61 (6"x24")

IN R10
A

IN

R10
A

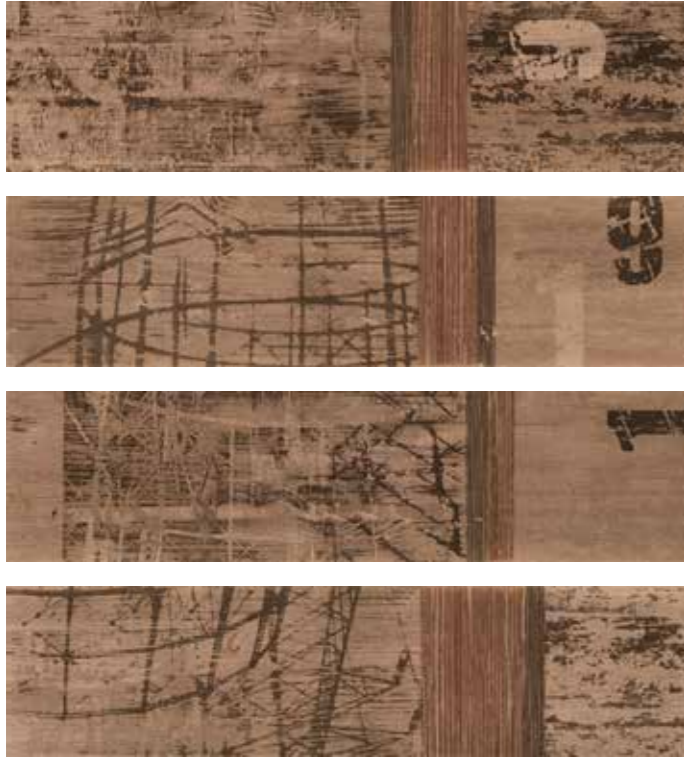

J84384 Tracce Marron Listone
15x61 (6"x24")



J84386 Tracce Marron Tozzetto
15x15 (6"x6")

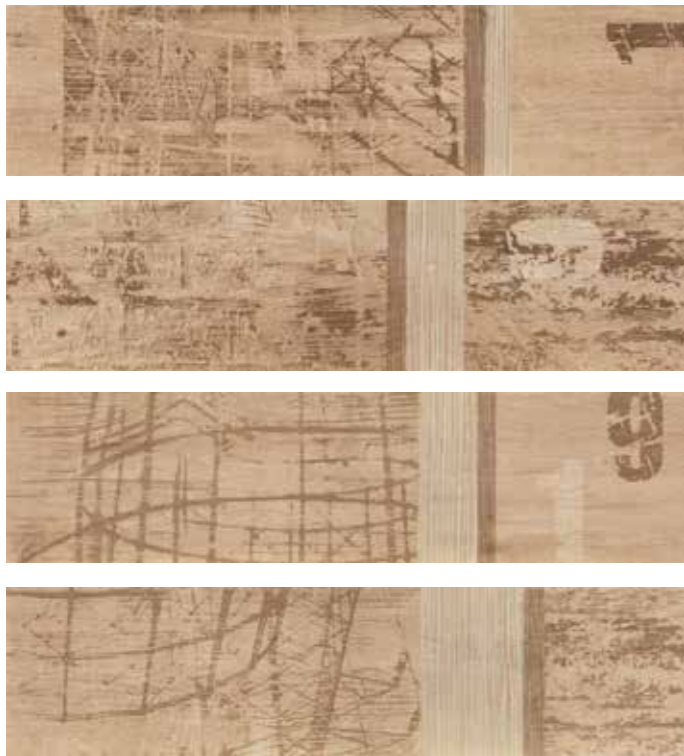

J84383 Tracce Beige Listone
15x61 (6"x24")



J84385 Tracce Beige Tozzetto
15x15 (6"x6")

IN

R10
A



J84578 Tracce Bianco Listone
15x61 (6"x24")



J84579 Tracce Bianco Tozzetto
15x15 (6"x6")



cappuccino sviluppo grafico 15x100 (6"x39 1/4")



20 15x100

GRAFICHE DIVERSE

DIFFERENT PATTERNS
DIFFÉRENTS MOTIFS
VERSCHIEDENE MUSTER

36 15x61

GRAFICHE DIVERSE

DIFFERENT PATTERNS
DIFFÉRENTS MOTIFS
VERSCHIEDENE MUSTER

	15x100 (6"x39 1/4")	GRIP 15x100 (6"x39 1/4")	15x61 (6"x24")	Beige Tracce Listone 15x61 (6"x24")	Beige Tracce Tozzetto 15x15 (6"x6")	Marron Tracce Listone 15x61 (6"x24")	Marron Tracce Tozzetto 15x15 (6"x6")	Bianco Tracce Listone 15x61 (6"x24")	Bianco Tracce Tozzetto 15x15 (6"x6")
FOG	J84616	J85347	J84576	-	-	-	-	J84578	J84579
ICE	J84618	-	J84577	-	-	-	-	J84578	J84579
CREAM	J84615	-	J84312	J84383	J84385	-	-	-	-
HONEY	J84617	J85348	J84311	J84383	J84385	-	-	-	-
CAPPUCCINO	J84613	J85344	J84310	-	-	J84384	J84386	-	-
CHOCOLATE	J84614	-	J84309	-	-	J84384	J84386	-	-
SPESSORE THICKNESS	9,5 mm	9,5 mm	9 mm	9 mm	9 mm	9 mm	9 mm	9 mm	9 mm
KG/M²	20,52	20,48	18,25	18,25	-	18,25	-	18,25	-
PZ/BOX	8	8	13	4	4	4	4	4	4
M²/BOX	1,23	1,23	1,2	-	-	-	-	-	-
BOX/PALLET	42	42	48	-	-	-	-	-	-
M²/PALLET	51,66	51,66	57,6	-	-	-	-	-	-
KG/PALLET	1060	1058,9	1051,2	-	-	-	-	-	-
€ <1 PALLET	51,60/m²	55,80/m²	39,60/m²	19,40 pz/pce	9,40 pz/pce	19,40 pz/pce	9,40 pz/pce	19,40 pz/pce	9,40 pz/pce
€ >1 PALLET	43,00/m²	46,50/m²	33,00/m²	19,40 pz/pce	9,40 pz/pce	19,40 pz/pce	9,40 pz/pce	19,40 pz/pce	9,40 pz/pce

	Battiscopa 8x45 (3 1/4"x18")	Gradino+Toro 100x15x4 (39 1/4"x6"x1 1/4")	Gradino+Toro 30x100x4 (12"x39 1/4"x1 1/4")	Angolo+Toro Dx 15x100x4 (6"x39 1/4"x1 1/4")	Angolo+Toro Sx 15x100x4 (6"x39 1/4"x1 1/4")	Gradino+Toro 15x30 (6"x12")	Angolo+Toro Dx 15x30 (6"x12")	Angolo+Toro Sx 15x30 (6"x12")
FOG	J84586	J84844	J84741	J84747	J84753	J84580	J84582	J84584
ICE	J84587	J84846	J84743	J84749	J84755	J84581	J84583	J84585
CREAM	J84328	J84843	J84740	J84746	J84752	J84316	J84320	J84324
HONEY	J84327	J84845	J84742	J84748	J84754	J84315	J84319	J84323
CAPPUCCINO	J84326	J84841	J84738	J84744	J84750	J84314	J84318	J84322
CHOCOLATE	J84325	J84842	J84739	J84745	J84751	J84313	J84317	J84321
PZ/BOX	30	2	1	2	2	8	2	2
€ /UM	5,40/ml	50,00 pz/pce	150,00 pz/pce	195,00 pz/pce	195,00 pz/pce	21,40 pz/pce	52,00 pz/pce	52,00 pz/pce

Contributo spese imballo € 10,00/pal (netto). - Packing charges € 10,00/pal (net)

Capucino Honey, Chocolate Ice, Fog GRIP

0,1% A · HA · LA OK 52,5 N/mm² 8 5 Classe IV Classe V Dcof: Wet 0,57 Dcof: Wet 0,70 Pendulum: Dry 52 · Wet 43



wall
Timeless - Tendina Ivory 24x150

floor
Timeless - Ivory 20x120+30x120

[Back to Index](#)

TIMELESS

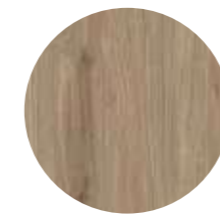

GREIGE



ECRÙ



IVORY



HONEY

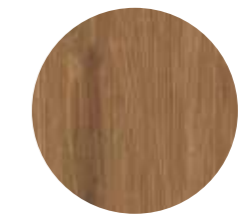

NUT



GRES PORCELLANATO SMALTATO
GLAZED PORCELAIN STONWARE
GRES CERAME EMAILLE
GLASIERTESFEINSTEINZEUG

Coordinato con:
Coordinated with:
TIMELESS 3D
SEZ. 3D
PG. 149

OUT

20 mm

h20

40x120 rett.
16"x48" rect.

8,5 mm

GRIP

24x150
9 1/2"x59"

IN

8,5 mm

24x150
9 1/2"x59"



60x120 rett.
24"x48" rect.



30x120 rett.
12"x48" rect.



20x120 rett.
8"x48" rect.



floor
Timeless - Ecrù 24x150

greige



J89454
24x150 (9 1/2"x59")



J89658 Tendina
24x150 (9 1/2"x59")



J89643
30x120 rett. (12"x48") rett.



J89648
20x120 rett. (8"x48") rett.



J89891 Chevron
60x120 rett. (24"x48") rett.

60x120 Chevron non presenta continuità grafica su nessun lato.

60x120 chevron has no graphic continuity on any side



h20



J89466 GRIP
24x150 (9 1/2"x59")



J89735 H20
40x120 rett. (16"x48") rett.

Disponibili pezzi speciali H20 a pag. 680

ecrù



J89453
24x150 (9 1/2"x59")



J89657 Tendina
24x150 (9 1/2"x59")



J89642
30x120 rett. (12"x48") rect.



J89647
20x120 rett. (8"x48") rect.



J89890 Chevron
60x120 rett. (24"x48") rect.

60x120 Chevron non presenta continuità grafica su nessun lato.

60x120 chevron has no graphic continuity on any side



J89465 GRIP
24x150 (9 1/2"x59")

h20



J89734 H20
40x120 rett. (16"x48") rect.

Disponibili pezzi speciali H20 a pag. 680



ivory



J89456
24x150 (9 1/2"x59")



J89660 Tendina
24x150 (9 1/2"x59")



J89645
30x120 rett. (12"x48") rect.



J89650
20x120 rett. (8"x48") rect.



J89893 Chevron
60x120 rett. (24"x48") rect.

60x120 Chevron non presenta continuità grafica su nessun lato.

60x120 chevron has no graphic continuity on any side



J89468 GRIP
24x150 (9 1/2"x59")

h20



J89737 H20
40x120 rett. (16"x48") rect.

Disponibili pezzi speciali H20 a pag. 680





honey



J89455
24x150 (9 1/2"x59")



J89659 Tendina
24x150 (9 1/2"x59")



J89644
30x120 rett. (12"x48") rect.



J89649
20x120 rett. (8"x48") rect.



J89892 Chevron
60x120 rett. (24"x48") rect.

60x120 Chevron non presenta continuità grafica su nessun lato.

60x120 chevron has no graphic continuity on any side



J89467 GRIP
24x150 (9 1/2"x59")

h20



J89736 H20
40x120 rett. (16"x48") rect.

Disponibili pezzi speciali H20 a pag. 680



nut



J89457
24x150 (9 1/2"x59")



J89661 Tendina
24x150 (9 1/2"x59")



J89646
30x120 rett. (12"x48") rect.



J89651
20x120 rett. (8"x48") rect.



J89894 Chevron
60x120 rett. (24"x48") rect.

60x120 Chevron non presenta continuità grafica su nessun lato.

60x120 chevron has no graphic continuity on any side



J89469 GRIP
24x150 (9 1/2"x59")

h20



J89738 H20
40x120 rett. (16"x48") rect.

Disponibili pezzi speciali H20 a pag. 680

nut sviluppo grafico 24x150 (9 1/2"x59")



10 40x120 h20

GRAFICHE DIVERSE
DIFFERENT PATTERNS
DIFFÉRENTS MOTIFS
VERSCHIEDENE MUSTER

24 24x150

GRAFICHE DIVERSE
DIFFERENT PATTERNS
DIFFÉRENTS MOTIFS
VERSCHIEDENE MUSTER

14 60x120

GRAFICHE DIVERSE
DIFFERENT PATTERNS
DIFFÉRENTS MOTIFS
VERSCHIEDENE MUSTER

24 30x120

GRAFICHE DIVERSE
DIFFERENT PATTERNS
DIFFÉRENTS MOTIFS
VERSCHIEDENE MUSTER

36 20x120

GRAFICHE DIVERSE
DIFFERENT PATTERNS
DIFFÉRENTS MOTIFS
VERSCHIEDENE MUSTER

	h20 40x120 rett. (16"x48") rect.	24x150 (9 1/2"x59")	GRIP 24x150 (9 1/2"x59")	Tendina 24x150 (9 1/2"x59")	Chevron 60x120 (24"x48")	30x120 (12"x48")	20x120 (8"x48")
GREIGE	J89735	J89454	J89466	J89658	J89891	J89643	J89648
ECRÛ	J89734	J89453	J89465	J89657	J89890	J89642	J89647
IVORY	J89737	J89456	J89468	J89660	J89893	J89645	J89650
HONEY	J89736	J89455	J89467	J89659	J89892	J89644	J89649
NUT	J89738	J89457	J89469	J89661	J89894	J89646	J89651
SPESSORE THICKNESS	20 mm	8,5 mm	8,5 mm	8,5 mm	8,5 mm	8,5 mm	8,5 mm
KG/M²	46,45	19,21	19,21	-	20,79	21,05	18,40
PZ/BOX	1	3	3	3	2	3	4
M²/BOX	0,48	1,08	1,08	-	1,44	1,08	0,96
BOX/PALLET	48	36	36	-	32	45	60
M²/PALLET	23,04	38,88	38,88	-	46,08	48,60	57,60
KG/PALLET	1070,4	747	747	-	958,08	947,25	1104
€ <1 PALLET	107,00/m²	59,30/m²	63,30/m²	140,20/m²	65,00/m²	68,70/m²	68,70/m²
€ >1 PALLET	93,00/m²	51,50/m²	55,00/m²	140,20/m²	56,50/m²	59,70/m²	59,70/m²

	Battiscopa 8x45 (3 1/2"x18")	Gradino+Toro 33x120x4 (13"x48"x1 1/2")	Angolo+Toro Dx 33x120x4 (13"x48"x1 1/2")	Angolo+Toro Sx 33x120x4 (13"x48"x1 1/2")	Gradone 40x120 rett. (16"x48") rect.
GREIGE	J89489	J89663	J89668	J89673	J89982
ECRÛ	J89488	J89662	J89667	J89672	J89981
IVORY	J89491	J89665	J89670	J89675	J89984
HONEY	J89490	J89664	J89669	J89674	J89983
NUT	J89492	J89666	J89671	J89676	J89985
PZ/BOX	30	2	1	1	1
€ /UM	5,40/ml	179,00 pz/pce	239,00 pz/pce	239,00 pz/pce	139,00 pz/pce

Contributo spese imballo € 10,00/pal (netto). - Packing charges € 10,00/pal (net)

Greige, Nut
Ecrû, Honey, Ivory
NATURALE
GRIP

< 0,1% A · HA · LA OK sp.8,5 mm > 45 N/mm² 5 Classe IV Classe V 7 Dcof: > 0,42 Pendulum: Dry > 36; Wet 25 < x < 35 8 Dcof: > 0,42 Pendulum: Dry/Wet: > 36

VINTAGE

[Back to Index](#)

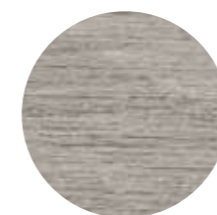

CENDRE



DORÈ



BRUNE



GRES PORCELLANATO SMALTATO
GLAZED PORCELAIN STONEWARE
GRES CERAME EMAILLE
GLASIERTESFEINSTEINZEUG

9,5 mm



7,5x45
3"x18"



7,5x40,7 CHEVRON
3"x16"



wall
Vintage - Cendre 7,5x40x7 Chevron

VINTAGE

R9
A



cendre



J86580
7,5x45 (3"x18")

J86583 Chevron
7,5x40,7 (3"x16")

dorè



J86581
7,5x45 (3"x18")

J86584 Chevron
7,5x40,7 (3"x16")

brune



J86579
7,5x45 (3"x18")

J86582 Chevron
7,5x40,7 (3"x16")

floor
Vintage - Brune 7,5x40,7 Chevron
Vintage - Dorè 7,5x45

brune sviluppo grafico 7,5x45 (3"x18")



96 7,5x45

GRAFICHE DIVERSE
DIFFERENT PATTERNS
DIFFÉRENTS MOTIFS
VERSCHIEDENE MUSTER

96 7,5x40,7

GRAFICHE DIVERSE
DIFFERENT PATTERNS
DIFFÉRENTS MOTIFS
VERSCHIEDENE MUSTER

	7,5x45 (3"x18")	Chevron 7,5x40,7 (3"x16")	Battiscopa 8x45 (3 1/4"x18")
CENDRE	J86580	J86583	J86917
DORÈ	J86581	J86584	J86918
BRUNE	J86579	J86582	J86916
SPESSORE THICKNESS	9,5 mm	9,5 mm	9,5 mm
KG/M²	20,22	20,12	-
PZ/BOX	26	26	30
M²/BOX	0,9	0,82	-
BOX/PALLET	42	42	-
M²/PALLET	37,8	34,44	-
KG/PALLET	764,4	693	-
€ <1 PALLET	58,20/m²	72,50/m²	5,40/ml
€ >1 PALLET	48,50/m²	63,00/m²	5,40/ml

Contributo spese imballo € 10,00/pal (netto). - Packing charges € 10,00/pal (net)



floor
Vintage - Dorè 7,5x40,7 Chevron
Vintage - Dorè 7,5x45



0,2%



A • HA • LA



OK



51,4 N/mm²



6



5



Brune
Classe IV



Dorè
Cendré
Classe V



Dcof: Wet 0,44
Pendulum:
Dry 45 • Wet 28



WOODIE

[Back to Index](#)



GREEN



BLUE



WHITE



BEIGE



BROWN



GRES PORCELLANATO SMALTATO
GLAZED PORCELAIN STONEWARE
GRES CERAME EMAILLE
GLASIERTESFEINSTEINZEUG

DESIGN BY

Andrea Castignano

9,5 mm



24x120
9 1/2"x48"



7,5x45
3"x18"



7,5x40,7 CHEVRON
3"x16"

wall
Woodie - White 7,5x40,7 Chevron

floor
Woodie - Green 24x120



green



J86576
24x120 (9 1/2"x48")

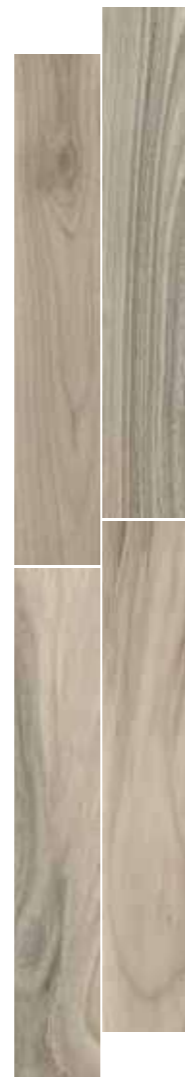

J86588
7,5x45 (3"x18")



J86593 Chevron
7,5x40,7 (3"x16")

blue



J86578
24x120 (9 1/2"x48")



J86586
7,5x45 (3"x18")



J86591 Chevron
7,5x40,7 (3"x16")



WOODIE



white



J86577
24x120 (9 1/2"x48")

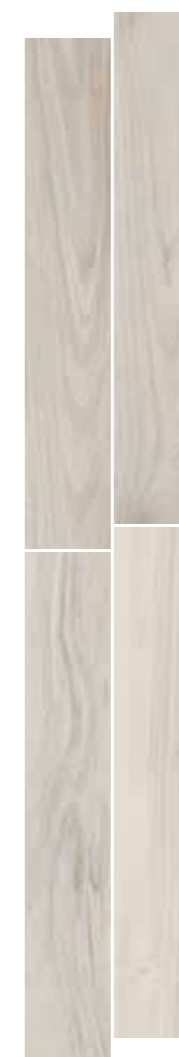

J86589
7,5x45 (3"x18")



J86594 Chevron
7,5x40,7 (3"x16")

floor
Woodie - White 7,5x45



beige



J86574
24x120 (9 1/2"x48")



J86585
7,5x45 (3"x18")



J86590 Chevron
7,5x40,7 (3"x16")

brown



J86575
24x120 (9 1/2"x48")



J86587
7,5x45 (3"x18")



J86592 Chevron
7,5x40,7 (3"x16")



beige sviluppo grafico 24x120 (9 1/2"x48")



240 7,5x45

GRAFICHE DIVERSE
DIFFERENT PATTERNS
DIFFÉRENTS MOTIFS
VERSCHIEDENE MUSTER

240 7,5x40,7

GRAFICHE DIVERSE
DIFFERENT PATTERNS
DIFFÉRENTS MOTIFS
VERSCHIEDENE MUSTER

23 24x120

GRAFICHE DIVERSE
DIFFERENT PATTERNS
DIFFÉRENTS MOTIFS
VERSCHIEDENE MUSTER

	24x120 (9 1/2"x48")	7,5x45 (3"x18")	Chevron 7,5x40,7 (3"x16")
GREEN	J86576	J86588	J86593
BLUE	J86578	J86586	J86591
WHITE	J86577	J86589	J86594
BEIGE	J86574	J86585	J86590
BROWN	J86575	J86587	J86592
SPESSORE THICKNESS	9,5 mm	9,5 mm	9,5 mm
KG/M²	20,17	20,22	20,12
PZ/BOX	4	26	26
M²/BOX	1,16	0,9	0,82
BOX/PALLET	45	42	42
M²/PALLET	52,20	37,8	34,44
KG/PALLET	1053	764,4	693
€ <1 PALLET	61,00/m²	60,00/m²	74,80/m²
€ >1 PALLET	53,00/m²	50,00/m²	65,00/m²

	Battiscopa 8x45 (3 1/2"x18")	Gradino+Toro 33x120x4 (13"x48"x1 1/2")	Angolo+Toro Dx 33x120x4 (13"x48"x1 1/2")	Angolo+Toro Sx 33x120x4 (13"x48"x1 1/2")
GREEN	J86899	J86904	J86909	J86914
BLUE	J86897	J86902	J86907	J86912
WHITE	J86900	J86905	J86910	J86915
BEIGE	J86896	J86901	J86906	J86911
BROWN	J86898	J86903	J86908	J86913
PZ/BOX	30	1	1	1
€/UM	5,40/ml	179,00 pz/pce	239,00 pz/pce	239,00 pz/pce

Contributo spese imballo € 10,00/pal (netto). - Packing charges € 10,00/pal (net)

 0,09%
  A · HA · LA
  OK
  51,4N/mm²
  7
  5
  Green
Classe IV
  Blue, White
Beige, Brown
Classe V
  R10
A
  V4
 Dcof: Wet 0,54
Pendulum:
Dry 42 · Wet 33

PIETRE & MARMI

// Le Pietre e i Marmi di Rondine ricreano, attraverso la più evoluta tecnologia ceramica, l'eleganza senza tempo di un elemento della natura che, con le sue infinite sfumature, sa essere versatile e intenso. Sono 17 le collezioni che Rondine ha dedicato alle pietre, con un'ampia gamma di colori e formati, per personalizzare ogni spazio architettonico, compreso l'outdoor. //

Through the most advanced ceramic technology, Pietre e Marmi di Rondine recreates the timeless elegance of an element of nature which, with its infinite shades, knows how to be versatile and intense. Rondine has dedicated 17 collections to stone, with a wide range of colours and sizes, to customise any architectural space, even outside.

Les Pierres et les Marbres de Rondine recréent, à travers la technologie céramique la plus évoluée, l'élégance atemporelle d'un élément de la nature qui, avec ses nuances infinies, sait être versatile et intense. Les collections que Rondine a consacrées aux pierres sont au nombre de 17 et se déclinent dans une vaste gamme de couleurs et de formats afin de personnaliser chaque espace architectural, y compris l'extérieur.

Eine hochentwickelte Keramiktechnik lässt die Steine und Marmor von Rondine mit der zeitlosen Eleganz eines Naturelements erscheinen, vielseitig und intensiv mit seinen unzähligen Nuancen. Rondine hat seinen Steinen 17 Kollektionen gewidmet, die in einer reichen Farbpalette und zahlreichen Formen präsentiert werden, um jedem Innen- und auch Außenraum eine persönliche Note zu verleihen.

Ardesie	323	Pietra di Panama	395
Aurelia	333	Pietre di Fiume	405
Baltic	339	Provence	413
Bluestone	351	Quarzi	427
Canova	355	Sandstones	435
Contract	367	Terre d'Otranto	441
Emilia	375	Valeria	449
Le Cave	381	Valsertal Stone	457
Piasentina	391		



wall
 Ardesie - Grey 30x60
 Ardesie - Mosaico Trapezi White 30x30

floor
 Ardesie - Grey 30x60

[Back to Index](#)

ARDESIE



GRES PORCELLANATO A IMPASTO COLORATO
 FULL BODY PORCELAIN STONEWARE
 GRES CERAME A PATE COLOREE
 DURCHGEFÄRBTES FEINSTEINZEUG

OUT		IN			
▼ 20 mm ▲	▼ 9,5 mm ▲	▼ 9,5 mm ▲			
h20			NATURALE / NATURAL LAPPATO / SEMIPOLISHED	NATURALE / NATURAL LAPPATO / SEMIPOLISHED	NATURALE / NATURAL LAPPATO / SEMIPOLISHED
[Grey Tile]	STRONG [Grey Tile]	[Grey Tile]	[Grey Tile]	[Grey Tile]	[Grey Tile]
40x120 rett. 16"x48" rect.	30,5x60,5 12"x24"	60x120 rett. 24"x48" rect.	60x60 rett. 24"x24" rect.	30x60 rett. 12"x24" rect.	30,5x60,5 12"x24"

IN R10
B

OUT STRONG
R11
C

dark



J86977
60x120 rett. (24"x48") rect.

J87188 Lappato/Semipolished
60x120 rett. (24"x48") rect.

3



J86989
60x60 rett. (24"x24") rect.

J87233 Lappato/Semipolished
60x60 rett. (24"x24") rect.

3



J87001
30x60 rett. (12"x24") rect.

J87194 Lappato/Semipolished
30x60 rett. (12"x24") rect.

3

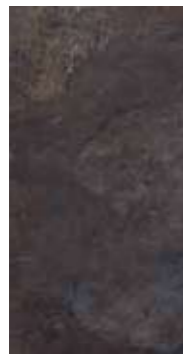

J86995
30,5x60,5 (12"x24")



J87145 Mosaico
30x30 (12"x12")

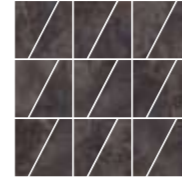

J87176 Mosaico Trapezio
30x30 (12"x12")



J87130 STRONG
30,5x60,5 (12"x24")

IN R10
B

OUT STRONG
h20
R11
C

grey



J86978
60x120 rett. (24"x48") rect.

J87189 Lappato/Semipolished
60x120 rett. (24"x48") rect.

4



J86990
60x60 rett. (24"x24") rect.

J87234 Lappato/Semipolished
60x60 rett. (24"x24") rect.

4



J87002
30x60 rett. (12"x24") rect.

J87195 Lappato/Semipolished
30x60 rett. (12"x24") rect.

4



J86996
30,5x60,5 (12"x24")

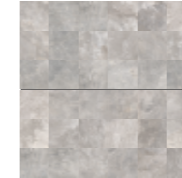

J87146 Mosaico
30x30 (12"x12")

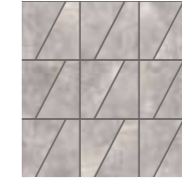

J87177 Mosaico Trapezio
30x30 (12"x12")

h20



J87162
40x120 rett. (16"x48") rect.

Disponibili pezzi speciali H20
a pag. 680



J87131 STRONG
30,5x60,5 (12"x24")

IN R10
B

OUT STRONG
R11
C

white



J86981
60x120 rett. (24"x48") rect.



J86993
60x60 rett. (24"x24") rect.



J87005
30x60 rett. (12"x24") rect.

J87192 Lappato/Semipolished
60x120 rett. (24"x48") rect.

4

J87237 Lappato/Semipolished
60x60 rett. (24"x24") rect.

4

J87198 Lappato/Semipolished
30x60 rett. (12"x24") rect.

4



J86999
30,5x60,5 (12"x24")



J87149 Mosaico
30x30 (12"x12")



J87180 Mosaico Trapezio
30x30 (12"x12")



J87134 STRONG
30,5x60,5 (12"x24")

beige



J86976
60x120 rett. (24"x48") rect.



J86988
60x60 rett. (24"x24") rect.



J87000
30x60 rett. (12"x24") rect.

J87187 Lappato/Semipolished
60x120 rett. (24"x48") rect.

4

J87232 Lappato/Semipolished
60x60 rett. (24"x24") rect.

4

J87193 Lappato/Semipolished
30x60 rett. (12"x24") rect.

4



J86994
30,5x60,5 (12"x24")

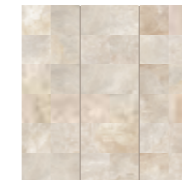

J87144 Mosaico
30x30 (12"x12")



J87175 Mosaico Trapezio
30x30 (12"x12")

h20

OUT STRONG
h20
R11
C



J87160
40x120 rett. (16"x48") rect.

Disponibili pezzi speciali H20
a pag. 680



J87129 STRONG
30,5x60,5 (12"x24")

IN R10
B

taupe



J86980
60x120 rett. (24"x48") rect.

J87191 Lappato/Semipolished
60x120 rett. (24"x48") rect.

3



J86992
60x60 rett. (24"x24") rect.

J87236 Lappato/Semipolished
60x60 rett. (24"x24") rect.

3



J87004
30x60 rett. (12"x24") rect.

J87197 Lappato/Semipolished
30x60 rett. (12"x24") rect.

3



J86998
30,5x60,5 (12"x24")



J87148 Mosaico
30x30 (12"x12")



J87179 Mosaico Trapezio
30x30 (12"x12")

h20



J87164
40x120 rett. (16"x48") rect.

Disponibili pezzi speciali H20
a pag. 680



J87133 STRONG
30,5x60,5 (12"x24")

OUT R11
C

STRONG
h20

multicolor



J86979
60x120 rett. (24"x48") rect.

J87190 Lappato/Semipolished
60x120 rett. (24"x48") rect.

3



J86991
60x60 rett. (24"x24") rect.

J87235 Lappato/Semipolished
60x60 rett. (24"x24") rect.

3



J87003
30x60 rett. (12"x24") rect.

J87196 Lappato/Semipolished
30x60 rett. (12"x24") rect.

3



J86997
30,5x60,5 (12"x24")



J87147 Mosaico
30x30 (12"x12")



J87178 Mosaico Trapezio
30x30 (12"x12")

h20



J87163
40x120 rett. (16"x48") rect.

Disponibili pezzi speciali H20
a pag. 680



J87132 STRONG
30,5x60,5 (12"x24")

IN R10
B

OUT R11
C

STRONG
h20

grey sviluppo grafico 60x60 rett. (24"x24") rett.



13 60x120

GRAFICHE DIVERSE
DIFFÉRENTS MOTIFS
VERSCHIEDENE MUSTER

25 60x60

GRAFICHE DIVERSE
DIFFÉRENTS MOTIFS
VERSCHIEDENE MUSTER

50 30x60

GRAFICHE DIVERSE
DIFFÉRENTS MOTIFS
VERSCHIEDENE MUSTER

10 40x120 h20

GRAFICHE DIVERSE
DIFFÉRENTS MOTIFS
VERSCHIEDENE MUSTER

	60x120 rett. (24"x48") rett.	Lappato/Semipol. 60x120 rett. (24"x48") rett.	60x60 rett. (24"x24") rett.	Lappato/Semipol. 60x60 rett. (24"x24") rett.	STRONG 30,5x60,5 (12"x24")	30,5x60,5 (12"x24")	30x60 rett. (12"x24") rett.	Lappato/Semipol. 30x60 rett. (12"x24") rett.	h20 40x120 rett. (16"x48") rett.
DARK	J86977	J87188	J86989	J87233	J87130	J86995	J87001	J87194	-
GREY	J86978	J87189	J86990	J87234	J87131	J86996	J87002	J87195	J87162
WHITE	J86981	J87192	J86993	J87237	J87134	J86999	J87005	J87198	-
BEIGE	J86976	J87187	J86988	J87232	J87129	J86994	J87000	J87193	J87160
TAUPE	J86980	J87191	J86992	J87236	J87133	J86998	J87004	J87197	J87164
MULTICOLOR	J86979	J87190	J86991	J87235	J87132	J86997	J87003	J87196	J87163
SPESSORE THICKNESS	9,5 mm	9,5 mm	9,5 mm	9,5 mm	9,5 mm	9,5 mm	9,5 mm	9,5 mm	20 mm
KG/M²	21,35	23,47	20,93	20,93	19,25	19,51	19,78	19,35	46,46
PZ/BOX	2	2	3	3	6	6	6	6	1
M²/BOX	1,44	1,44	1,08	1,08	1,11	1,11	1,08	1,08	0,48
BOX/PALLET	32	32	40	40	48	48	48	48	48
M²/PALLET	46,08	46,08	43,20	43,20	53,28	53,28	51,84	51,84	23,04
KG/PALLET	984	1081	904	904	1025,8	1039,7	1025,3	1003,2	1070,4
€ <1 PALLET	65,00/m²	88,00/m²	54,00/m²	63,30/m²	46,10/m²	42,00/m²	46,10/m²	61,50/m²	107,00/m²
€ >1 PALLET	56,50/m²	76,50/m²	45,00/m²	55,00/m²	38,40/m²	35,00/m²	38,40/m²	53,40/m²	93,00/m²

	Mosaico 30x30 (12"x12")	Mosaico Trapezio 30x30 (12"x12")	Battiscopa 7,5x60 (3"x24")	Gradino 40x120 rett. (16"x48") rett.	Gradino+Toro 33x120x4 (13"x48"x1 1/2")	Angolo+Toro Dx 33x120x4 (13"x48"x1 1/2")	Angolo+Toro Sx 33x120x4 (13"x48"x1 1/2")
DARK	J87145	J87176	J87244	-	J87250	J87256	J87262
GREY	J87146	J87177	J87245	J87269	J87251	J87257	J87263
WHITE	J87149	J87180	J87248	-	J87254	J87260	J87266
BEIGE	J87144	J87175	J87243	J87267	J87249	J87255	J87261
TAUPE	J87148	J87179	J87247	J87271	J87253	J87259	J87265
MULTICOLOR	J87147	J87178	J87246	J87270	J87252	J87258	J87264
PZ/BOX	6	6	12	1	2	1	1
€/UM	122,20/m²	179,00/m²	9,30 pz/pce	139,00 pz/pce	179,00 pz/pce	239,00 pz/pce	239,00 pz/pce

Contributo spese imballo € 10,00/pal (netto). - Packing charges € 10,00/pal (net)

< 0,2 %
 A · HA · LA
 OK
 > 40 N/mm²
 6
 5
 Classe IV
 Classe V
 R10 B
 R11 C
 R11 C
 V4

Taupe, Dark, Multicolor
 White, Beige, Grey
 STRONG
 h20

Dcof: Wet 0,74 Pendulum: Dry 49 · Wet 34
 Dcof: Wet 0,76 Pendulum: Dry 54 · Wet 46
 Dcof: Wet 0,64 Pendulum: Dry 53 · Wet 44



floor
Aurelia - Grigio Lineare 60x60

[Back to Index](#)

AURELIA

Designed and registered by Rondine

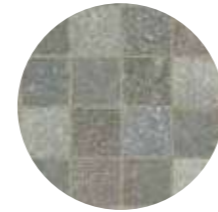

GRIGIO

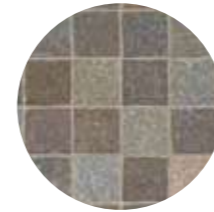

BRUNO



PIETRE & MARMI

GRES PORCELLANATO A IMPASTO COLORATO
 FULL BODY PORCELAIN STONWARE
 GRES CERAME A PATE COLOREE
 DURCHGEFÄRBTES FEINSTEINZEUG

Coordinato con:
 Coordinated with:
LE CAVE
 SEZ. PIETRE E MARMI
 PG. 381



20 mm

h20

SMART
EDGE



60x60 rett.
24"x24" rect.



60,5x60,5
24"x24"

9,5 mm



60,5x60,5
24"x24"



grigio lineare



9,5 mm **J88243** 60,5x60,5 (24"x24")

20 mm **J88185** 60x60 rett. (24"x24") rect.

20 mm **J88298** 60,5x60,5 (24"x24") Smart Edge

Disponibili pezzi speciali H20 a pag. 683

bruno lineare



9,5 mm **J88240** 60,5x60,5 (24"x24")

20 mm **J88182** 60x60 rett. (24"x24") rect.

20 mm **J88295** 60,5x60,5 (24"x24") Smart Edge

Disponibili pezzi speciali H20 a pag. 683

grigio arco



9,5 mm **J88241** 60,5x60,5 (24"x24")

20 mm **J88183** 60x60 rett. (24"x24") rect.

20 mm **J88296** 60,5x60,5 (24"x24") Smart Edge

Disponibili pezzi speciali H20 a pag. 683

bruno arco



9,5 mm **J88238** 60,5x60,5 (24"x24")

20 mm **J88180** 60x60 rett. (24"x24") rect.

20 mm **J88293** 60,5x60,5 (24"x24") Smart Edge

Disponibili pezzi speciali H20 a pag. 683

grigio arco bianco



9,5 mm **J88242** 60,5x60,5 (24"x24")

20 mm **J88184** 60x60 rett. (24"x24") rect.

20 mm **J88297** 60,5x60,5 (24"x24") Smart Edge

Disponibili pezzi speciali H20 a pag. 683

bruno arco bianco



9,5 mm **J88239** 60,5x60,5 (24"x24")

20 mm **J88181** 60x60 rett. (24"x24") rect.

20 mm **J88294** 60,5x60,5 (24"x24") Smart Edge

Disponibili pezzi speciali H20 a pag. 683

bruno lineare sviluppo grafico 60,5x60,5 (24"x24")

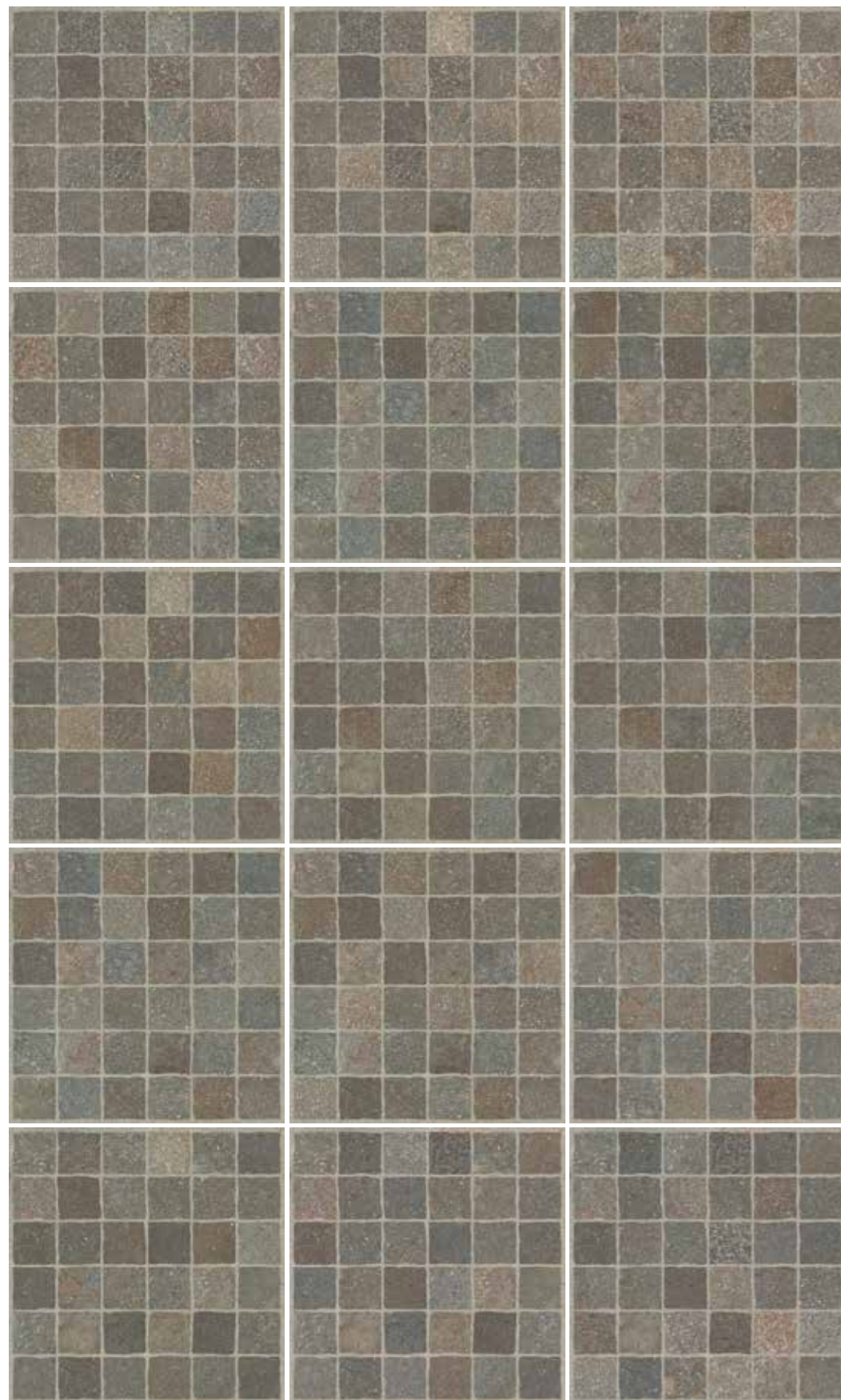

540 TOZZETTI







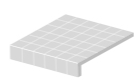

GRAFICHE DIVERSE

DIFFERENT PATTERNS
DIFFÉRENTS MOTIFS
VERSCHIEDENE MUSTER

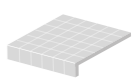
15 60x60

GRAFICHE DIVERSE

DIFFERENT PATTERNS
DIFFÉRENTS MOTIFS
VERSCHIEDENE MUSTER

	 60,5x60,5 (24"x24")	 60,5x60,5x10 (24"x24"x4")	 60,5x60,5 Smart Edge (24"x24") Smart Edge	 60x60 rett. (24"x24") rect.	 60x60x10 rett. (24"x24"x4") rect.
GRIGIO					
 ARCO	J88241	-	J88296	J88183	-
 ARCO BIANCO	J88242	-	J88297	J88184	-
 LINEARE	J88243	J88353	J88298	J88185	J88354
BRUNO					
 ARCO	J88238	-	J88293	J88180	-
 ARCO BIANCO	J88239	-	J88294	J88181	-
 LINEARE	J88240	J88351	J88295	J88182	J88352
SPESSORE THICKNESS	9,5 mm	9,5 mm	20 mm	20 mm	20 mm
KG/M²	20,45	-	43,15	43,19	-
PZ/BOX	3	1	2	2	1
M²/BOX	1,10	-	0,73	0,72	-
BOX/PALLET	40	-	32	32	-
M²/PALLET	44,00	-	23,36	23,04	-
KG/PALLET	900	-	1008	995,2	-
€ <1 PALLET	54,00/m²	50,00 pz/pce	80,00/m²	84,00/m²	88,00 pz/pce
€ >1 PALLET	45,00/m²	50,00 pz/pce	69,50/m²	73,00/m²	88,00 pz/pce

Contributo spese imballo € 10,00/pal (netto). - Packing charges € 10,00/pal (net)



0,1%



A • HA • LA



OK



sp.10 mm > 45 N/mm²
sp.20 mm > 55 N/mm²



8



5

h20



>150 N/mm²



Dcof: Wet 0,72
Pendulum:
Dry 55 • Wet 47



V3



floor
Baltic - Grey 60x120

[Back to Index](#)

BALTIC

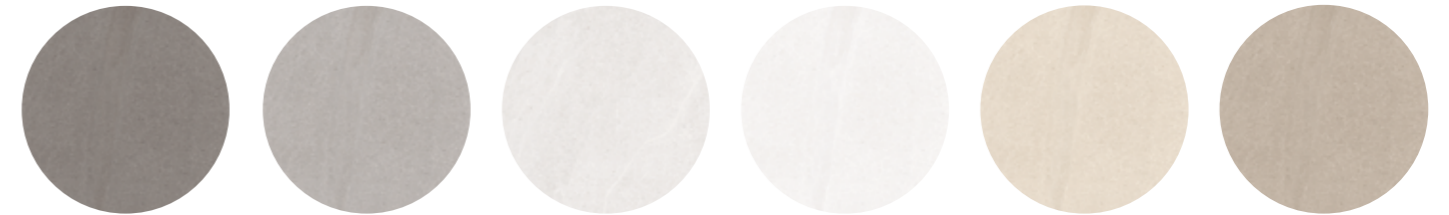

DARK GREY

GREY

LIGHT GREY

WHITE

BEIGE

TAUPE



GRES PORCELLANATO A IMPASTO COLORATO
 FULL BODY PORCELAIN STONEWARE
 GRES CERAME A PATE COLOREE
 DURCHGEFÄRBTES FEINSTEINZEUG

OUT 8,5 mm

IN 8,5 mm

GRIP



60x120 rett.
24"x48" rect.



60x120 rett.
24"x48" rect.



100x100 rett.
39 1/4"x39 1/4" rect.



60x60 rett.
24"x24" rect.



30x60 rett.
12"x24" rect.



floor
Baltic - Grey 60x120

IN R10
B

dark grey



J89758
60x120 rett. (24"x48") rect.



J90368
100x100 rett. (39 1/4"x39 1/4") rect.



J89770
60x60 rett. (24"x24") rect.



J89782
30x60 rett. (12"x24") rect.

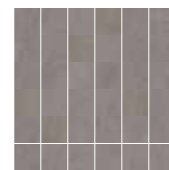

J89848 Mosaico
30x30 (12"x12")

OUT R11
C



J89794 GRIP
60x120 rett. (24"x48") rect.

grey



J89759
60x120 rett. (24"x48") rect.



J89771
60x60 rett. (24"x24") rect.



J90369
100x100 rett. (39 1/4"x39 1/4") rect.



J89783
30x60 rett. (12"x24") rect.

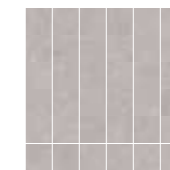

J89849 Mosaico
30x30 (12"x12")

IN R10
B

OUT R11
C



J89795 GRIP
60x120 rett. (24"x48") rect.

IN R10
B

light grey



J89760
60x120 rett. (24"x48") rect.



J90370
100x100 rett. (39 1/4"x39 1/4") rect.



J89772
60x60 rett. (24"x24") rect.

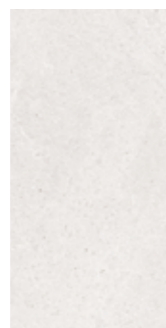

J89784
30x60 rett. (12"x24") rect.

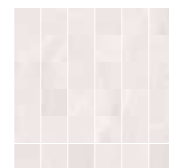

J89850 Mosaico
30x30 (12"x12")

OUT R11
C



J89796 GRIP
60x120 rett. (24"x48") rect.

white

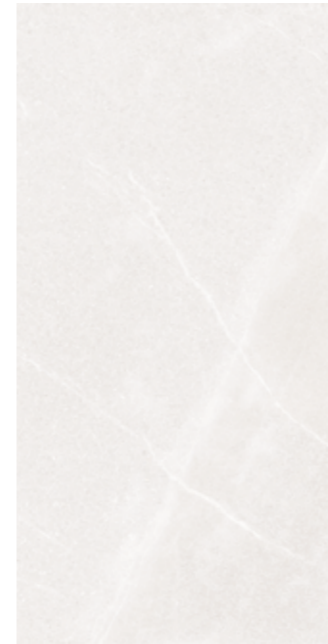

J89762
60x120 rett. (24"x48") rect.



J90372
100x100 rett. (39 1/4"x39 1/4") rect.



J89774
60x60 rett. (24"x24") rect.



J89786
30x60 rett. (12"x24") rect.

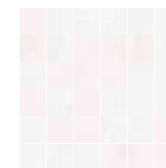

J89852 Mosaico
30x30 (12"x12")

IN R10
B

OUT R11
C



J89798 GRIP
60x120 rett. (24"x48") rect.

IN R10
B

beige



J89757
60x120 rett. (24"x48") rect.



J90367
100x100 rett. (39 1/4"x39 1/4") rect.

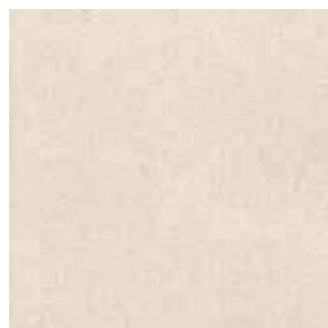

J89769
60x60 rett. (24"x24") rect.

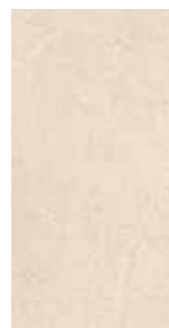

J89781
30x60 rett. (12"x24") rect.

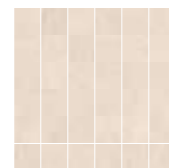

J89847 Mosaico
30x30 (12"x12")

OUT R11
C

taupe



J89793 GRIP
60x120 rett. (24"x48") rect.



J89761
60x120 rett. (24"x48") rect.



J90371
100x100 rett. (39 1/4"x39 1/4") rect.



J89773
60x60 rett. (24"x24") rect.

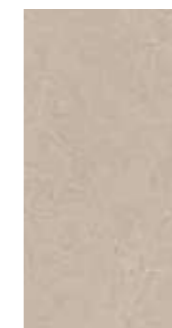

J89785
30x60 rett. (12"x24") rect.

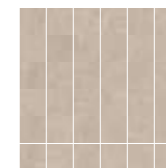

J89851 Mosaico
30x30 (12"x12")

IN R10
B

OUT R11
C



J89797 GRIP
60x120 rett. (24"x48") rect.

grey sviluppo grafico 60x120 rett. (24"x48") rett.



13 100x100

GRAFICHE DIVERSE
DIFFERENT PATTERNS
DIFFÉRENTS MOTIFS
VERSCHIEDENE MUSTER

18 60x120

GRAFICHE DIVERSE
DIFFERENT PATTERNS
DIFFÉRENTS MOTIFS
VERSCHIEDENE MUSTER





36 60x60

GRAFICHE DIVERSE
DIFFERENT PATTERNS
DIFFÉRENTS MOTIFS
VERSCHIEDENE MUSTER

72 30x60

GRAFICHE DIVERSE
DIFFERENT PATTERNS
DIFFÉRENTS MOTIFS
VERSCHIEDENE MUSTER

	100x100 rett. (39 1/4"x39 1/4") rect.	60x120 rett. (24"x48") rect.	GRIP 60x120 rett. (24"x48") rect.	60x60 rett. (24"x24") rect.	30x60 rett. (12"x24") rect.
DARK GREY	J90368	J89758	J89794	J89770	J89782
GREY	J90369	J89759	J89795	J89771	J89783
LIGHT GREY	J90370	J89760	J89796	J89772	J89784
WHITE	J90372	J89762	J89798	J89774	J89786
BEIGE	J90367	J89757	J89793	J89769	J89781
TAUPE	J90371	J89761	J89797	J89773	J89785
SPESSORE THICKNESS	8,5 mm	8,5 mm	8,5 mm	8,5 mm	8,5 mm
KG/M²	20,00	19,32	19,32	19,07	19,04
PZ/BOX	2	2	2	3	7
M²/BOX	2,00	1,44	1,44	1,08	1,26
BOX/PALLET	24	32	32	40	48
M²/PALLET	48,00	46,08	46,08	43,20	60,48
KG/PALLET	960	890,56	890,56	824	1152
€ <1 PALLET	69,00/m²	65,00 / m²	68,50 / m²	54,00 / m²	46,10 / m²
€ >1 PALLET	60,00/m²	56,50 / m²	59,50 / m²	45,00 / m²	38,40 / m²

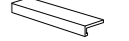
	 Mosaico 30x30 (12"x12")	 Battiscopa 7,5x60 (3"x24")	 Gradino + Toro 33x120x4 (13"x48"x1 1/2")	 Angolo + Toro Dx 33x120x4 (13"x48"x1 1/2")	 Angolo + Toro Sx 33x120x4 (13"x48"x1 1/2")	 Elemento a L incollato GRIP 30x120x5 (12"x48"x2")
DARK GREY	J89848	J89824	J89830	J89836	J89842	J89872
GREY	J89849	J89825	J89831	J89837	J89843	J89873
LIGHT GREY	J89850	J89826	J89832	J89838	J89844	J89874
WHITE	J89852	J89828	J89834	J89840	J89846	J89876
BEIGE	J89847	J89823	J89829	J89835	J89841	J89871
TAUPE	J89851	J89827	J89833	J89839	J89845	J89875
PZ/BOX	6	12	2	1	1	2
€ /UM	122,20 / m²	9,30 pz / pce	179,00 pz / pce	239,00 pz / pce	239,00 pz / pce	120,00 pz / pce

Contributo spese imballo € 10,00/pal (netto). - Packing charges € 10,00/pal (net)

Contributo spese imballo € 20,00/pal (netto) per formato 100x100 sp. 8,5 mm - Packing charges € 20,00/pal (net) for size 100x100 th. 8,5 mm

Dark Grey, Grey, Taupe Beige, Light Grey, White **NATURALE** **GRIP**

 0,1%
  A · HA · LA
  OK
  sp,8,5 mm > 45 N/mm²
  5
  Classe IV
  Classe V
  7
  Dcof: > 0,42
Pendulum:
Dry/Wet > 36
  8
  Dcof: > 0,42
Pendulum:
Dry/Wet > 36
  V1

BLUESTONE

[Back to Index](#)

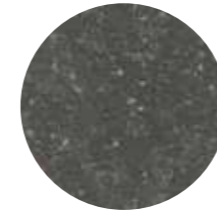

BLACK

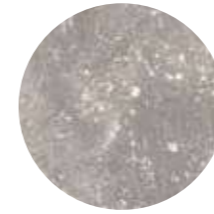

GREY



**PIETRE
&
MARM**

GRES PORCELLANATO A IMPASTO COLORATO
FULL BODY PORCELAIN STONEWARE
GRES CERAME A PATE COLOREE
DURCHGEFÄRBTES FEINSTEINZEUG



SMART
EDGE



20x30
8"x12"

SMART
EDGE



20x20
8"x8"

Bluestone - 20x30 - 20x20

OUT R11
C

black



J88851
20x30 (8"x12") Smart Edge



J88849
20x20 (8"x8") Smart Edge

grey



J88852
20x30 (8"x12") Smart Edge



J88850
20x20 (8"x8") Smart Edge

grey sviluppo grafico 20x20 (8"x8")



60 20x20
GRAFICHE DIVERSE
DIFFERENT PATTERNS
DIFFÉRENTS MOTIFS
VERSCHIEDENE MUSTER

50 20x30
GRAFICHE DIVERSE
DIFFERENT PATTERNS
DIFFÉRENTS MOTIFS
VERSCHIEDENE MUSTER

	h20 20x30 Smart Edge (8"x12") Smart Edge	h20 20x20 Smart Edge (8"x8") Smart Edge	h20 Griglia 20x30 (8"x12")
● BLACK	J88851	J88849	J89158
● GREY	J88852	J88850	J89159
SPESSORE THICKNESS	20 mm	20 mm	20 mm
KG/M ²	40,37	40,77	-
PZ/BOX	9	13	6
M ² /BOX	0,54	0,52	-
BOX/PALLET	64	68	-
M ² /PALLET	34,56	35,36	-
KG/PALLET	1395,2	1441,6	-
€ <1 PALLET	114,50/m ²	114,50/m ²	65,00 pz/pce
€ >1 PALLET	99,50/m ²	99,50/m ²	65,00 pz/pce

Contributo spese imballo € 10,00/pal (netto). - Packing charges € 10,00/pal (net)



0,10%



A • HA • LA



OK



>35 N/mm²



8



5



<140 N/mm²



Dcof: Wet 0,42
Pendulum:
Dry 69 • Wet 60



CANOVA

[Back to Index](#)



EMPERADOR



STATUARIO



ARABESCATO

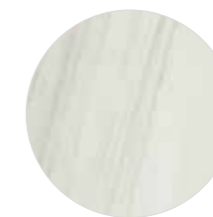

LASA WHITE



CARNICO

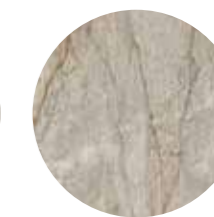

OXFORD GREY



**PIETRE
&
MARM**

GRES PORCELLANATO A IMPASTO COLORATO
FULL BODY PORCELAIN STONEWARE
GRES CERAME A PATE COLOREE
DURCHGEFÄRBTES FEINSTEINZEUG

9,5 mm

NATURALE / NATURAL
FULL LAPPATO / POLISHED



60x120 rett.
24"x48" rect.

NATURALE / NATURAL
FULL LAPPATO / POLISHED



60x60 rett.
24"x24" rect.

NATURALE / NATURAL
FULL LAPPATO / POLISHED



30x60 rett.
12"x24" rect.

wall
Canova - Statuario 60x120
Canova - B&W Prestige 30x30

floor
Canova - Statuario 60x120



emperador

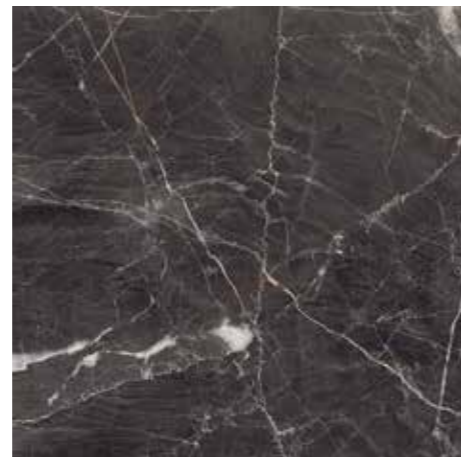

J88478
60x120 rett. (24"x48") rect.

J88518 Full Lap./Polished
60x120 rett. (24"x48") rect.

J88494
60x60 rett. (24"x24") rect.

J88888 Full Lap./Polished
60x60 rett. (24"x24") rect.

J88510
30x60 rett. (12"x24") rect.

J88894 Full Lap./Polished
30x60 rett. (12"x24") rect.

b&w prestige

b&w 01

b&w 02

b&w 03

mosaico

esagona

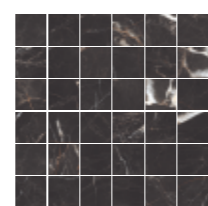
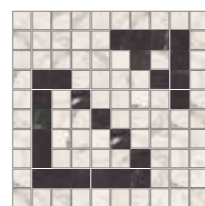
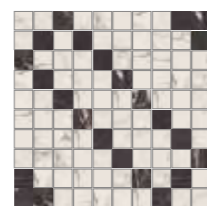
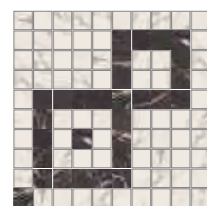

J88565 Full Lap./Polished
30x30 (12"x12")

J88566 Full Lap./Polished
30x30 (12"x12")

J88567 Full Lap./Polished
30x30 (12"x12")

J88568 Full Lap./Polished
30x30 (12"x12")

J88573
30x30 (12"x12")

J88578 Full Lap./Polished
35x30,3 (14"x12")



statuario



J88474
60x120 rett. (24"x48") rect.

J88514 Full Lap./Polished
60x120 rett. (24"x48") rect.

J88490
60x60 rett. (24"x24") rect.

J88891 Full Lap./Polished
60x60 rett. (24"x24") rect.

J88506
30x60 rett. (12"x24") rect.

J88897 Full Lap./Polished
30x60 rett. (12"x24") rect.

b&w prestige

b&w 01

b&w 02

b&w 03

mosaico

esagona

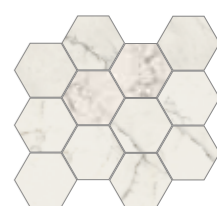
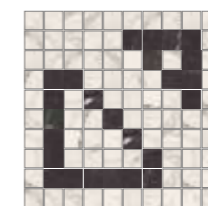
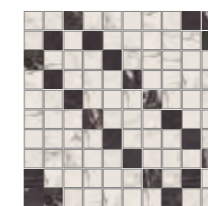
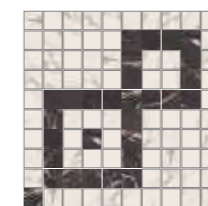

J88565 Full Lap./Polished
30x30 (12"x12")

J88566 Full Lap./Polished
30x30 (12"x12")

J88567 Full Lap./Polished
30x30 (12"x12")

J88568 Full Lap./Polished
30x30 (12"x12")

J88569
30x30 (12"x12")

J88574 Full Lap./Polished
35x30,3 (14"x12")



arabescato



J88476
60x120 rett. (24"x48") rect.

J88516 Full Lap./Polished
60x120 rett. (24"x48") rect.

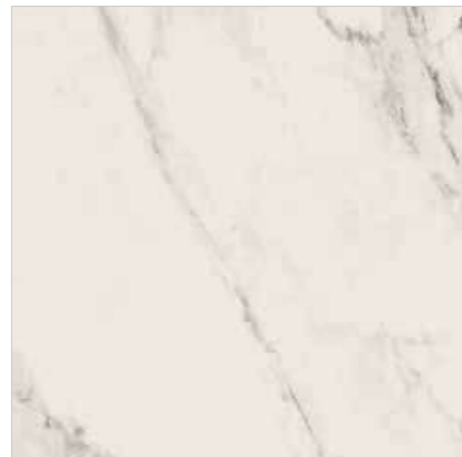

J88492
60x60 rett. (24"x24") rect.

J88886 Full Lap./Polished
60x60 rett. (24"x24") rect.



J88508
30x60 rett. (12"x24") rect.

J88892 Full Lap./Polished
30x60 rett. (12"x24") rect.

lasa white



J88555
60x120 rett. (24"x48") rect.

J88859 Full Lap./Polished
60x120 rett. (24"x48") rect.



J88857
60x60 rett. (24"x24") rect.

J88889 Full Lap./Polished
60x60 rett. (24"x24") rect.



J88858
30x60 rett. (12"x24") rect.

J88895 Full Lap./Polished
30x60 rett. (12"x24") rect.

mosaico

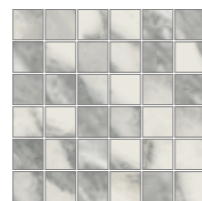

J88571
30x30 (12"x12")

esagona



J88576 Full Lap./Polished
35x30,3 (14"x12")

mosaico



J88860
30x30 (12"x12")

esagona



J88861 Full Lap./Polished
35x30,3 (14"x12")



carnico



J88475
60x120 rett. (24"x48") rett.

J88515 Full Lap./Polished
60x120 rett. (24"x48") rett.



J88491
60x60 rett. (24"x24") rett.

J88887 Full Lap./Polished
60x60 rett. (24"x24") rett.



J88507
30x60 rett. (12"x24") rett.

J88893 Full Lap./Polished
30x60 rett. (12"x24") rett.

oxford grey



J88871
60x120 rett. (24"x48") rett.

J88875 Full Lap./Polished
60x120 rett. (24"x48") rett.



J88873
60x60 rett. (24"x24") rett.

J88890 Full Lap./Polished
60x60 rett. (24"x24") rett.



J88874
30x60 rett. (12"x24") rett.

J88896 Full Lap./Polished
30x60 rett. (12"x24") rett.

mosaico

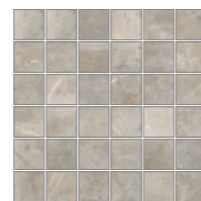

J88570
30x30 (12"x12")

esagona



J88575 Full Lap./Polished
35x30,3 (14"x12")

mosaico

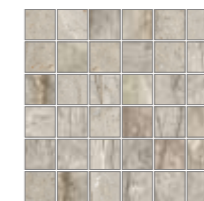

J88876
30x30 (12"x12")

esagona



J88877 Full Lap./Polished
35x30,3 (14"x12")

b&w prestige



J88565 Full Lap./Polished
30x30 (12"x12")

solution A

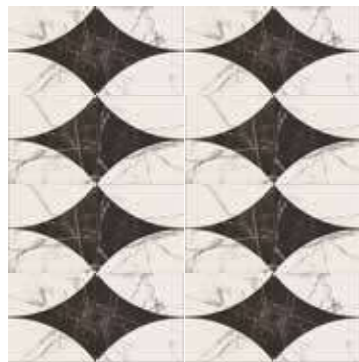

solution B

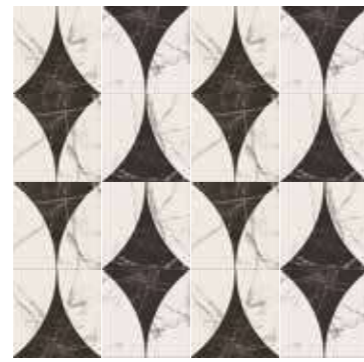

solution C

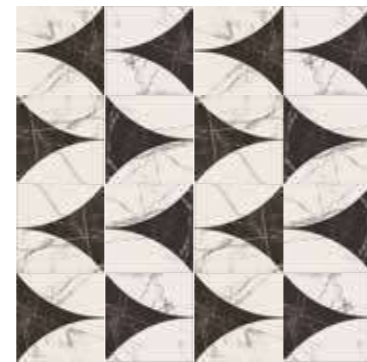

mosaico b&w 02



J88567 Full Lap./Polished
30x30 (12"x12")

solution A



solution B

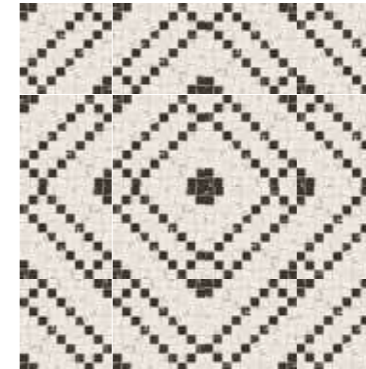

solution C



mosaico b&w 01



J88566 Full Lap./Polished
30x30 (12"x12")

solution A

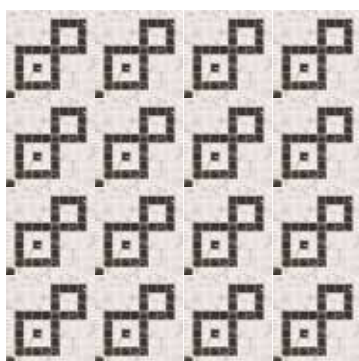

solution B

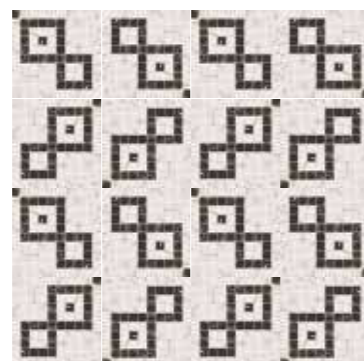

solution C

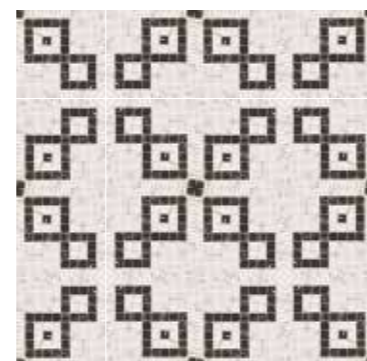

mosaico b&w 03

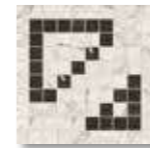

J88568 Full Lap./Polished
30x30 (12"x12")

solution A

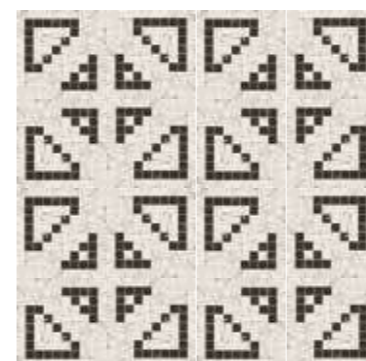

solution B



solution C

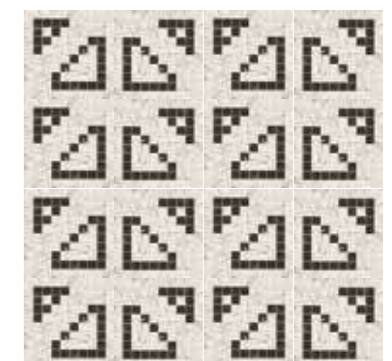

arabescato sviluppo grafico 60x120 rett. (24"x48") rett.



18 60x120

GRAFICHE DIVERSE
DIFFERENT PATTERNS
DIFFÉRENTS MOTIFS
VERSCHIEDENE MUSTER

36 60x60

GRAFICHE DIVERSE
DIFFERENT PATTERNS
DIFFÉRENTS MOTIFS
VERSCHIEDENE MUSTER

72 30x60

GRAFICHE DIVERSE
DIFFERENT PATTERNS
DIFFÉRENTS MOTIFS
VERSCHIEDENE MUSTER

	60x120 rett. (24"x48") rett.	Full Lappato 60x120 rett. (24"x48") rett.	60x60 rett. (24"x24") rett.	Full Lappato 60x60 rett. (24"x24") rett.	30x60 rett. (12"x24") rett.	Full Lappato 30x60 rett. (12"x24") rett.	B&W Prestige 30x30 (12"x12")	B&W 01 30x30 (12"x12")	B&W 02 30x30 (12"x12")	B&W 03 30x30 (12"x12")
EMPERADOR	J88478	J88518	J88494	J88888	J88510	J88894	J88565	J88566	J88567	J88568
STATUARIO	J88474	J88514	J88490	J88891	J88506	J88897	J88565	J88566	J88567	J88568
ARABESCATO	J88476	J88516	J88492	J88886	J88508	J88892	-	-	-	-
CARNICO	J88475	J88515	J88491	J88887	J88507	J88893	-	-	-	-
LASA WHITE	J88855	J88859	J88857	J88889	J88858	J88895	-	-	-	-
OXFORD GREY	J88871	J88875	J88873	J88890	J88874	J88896	-	-	-	-
SPESSORE THICKNESS	9,5 mm	9,5 mm	9,5 mm	9,5 mm	9,5 mm	9,5 mm	9,5 mm	9,5 mm	9,5 mm	9,5 mm
KG/M²	21,15	21,38	21,60	21,38	21,47	21,38	-	-	-	-
PZ/BOX	2	2	3	3	6	6	6	6	6	6
M²/BOX	1,44	1,44	1,08	1,08	1,08	1,08	-	-	-	-
BOX/PALLET	32	30	40	40	48	40	-	-	-	-
M²/PALLET	46,08	43,20	43,20	43,20	51,84	43,20	-	-	-	-
KG/PALLET	974,7	924	932,80	924	1113,12	924	-	-	-	-
€ <1 PALLET	65,00/m²	92,00/m²	60,00/m²	84,00/m²	56,10/m²	80,00/m²	435,00/m²	191,00/m²	191,00/m²	191,00/m²
€ >1 PALLET	56,50/m²	80,00/m²	50,00/m²	73,00/m²	46,70/m²	69,50/m²	435,00/m²	191,00/m²	191,00/m²	191,00/m²

	Mosaico 30x30 (12"x12")	Esagona Full Lap. 35x30,3 (14"x12")	Battiscopa 7,5x60 rett. (3"x24") rett.	Gradino+Toro 33x120 (13"x48")	Angolo+Toro Dx 33x120 (13"x48")	Angolo+Toro Sx 33x120 (13"x48")	Battiscopa Lapp. 7,5x60 rett. (3"x24") rett.	Gradino+Toro Lapp. 33x120 (13"x48")	Angolo+Toro Dx Lapp. 33x120 (13"x48")	Angolo+Toro Sx Lapp. 33x120 (13"x48")
EMPERADOR	J88573	J88578	J88583	J88593	J88598	J88603	J88588	J88608	J88672	J88677
STATUARIO	J88569	J88574	J88579	J88589	J88594	J88599	J88584	J88604	J88668	J88673
ARABESCATO	J88571	J88576	J88581	J88591	J88596	J88601	J88586	J88606	J88670	J88675
CARNICO	J88570	J88575	J88580	J88590	J88595	J88600	J88585	J88605	J88669	J88674
LASA WHITE	J88860	J88861	J88862	J88864	J88865	J88866	J88863	J88867	J88868	J88869
OXFORD GREY	J88876	J88877	J88878	J88880	J88881	J88882	J88879	J88883	J88884	J88885
PZ/BOX	6	6	12	2	1	1	12	2	1	1
€ /UM	122,20/m²	225,00/m²	9,30 pz/pce	179,00 pz/pce	239,00 pz/pce	239,00 pz/pce	12,00 pz/pce	195,00 pz/pce	254,00 pz/pce	254,00 pz/pce

Contributo spese imballo € 10,00/pal (netto). - Packing charges € 10,00/pal (net)

<0,1%	A · HA · LA A · HB · LB Full Lappato	OK	>45 N/mm²	7 6 Full Lappato	5	<150 mm³	Classe IV	Classe V	Dcof: Wet 0,65 Pendulum: Dry >36 · Wet 25-35	



floor
Contract - Anthracite 60x60

[Back to Index](#)

CONTRACT



ANTHRACITE



GREY



SILVER



WHITE



IVORY



**PIETRE
&
MARM**

GRES PORCELLANATO A IMPASTO COLORATO
FULL BODY PORCELAIN STONEWARE
GRES CERAME A PATE COLOREE
DURCHGEFÄRBTES FEINSTEINZEUG

9,5 mm

NATURALE / NATURAL
LAPPATO / SEMIPOLISHED



60x60 rett.
24"x24" rect.

NATURALE / NATURAL
LAPPATO / SEMIPOLISHED



30x60 rett.
12"x24" rect.



60,5x60,5
24"x24"



30,5x60,5
12"x24"

anthracite



J84028
60,5x60,5 (24"x24")



J83700
30,5x60,5 (12"x24")



J84031
60x60 rett. (24"x24") rect.



J83704
30x60 rett. (12"x24") rect.



J84034 Lappato/Semipolished
60x60 rett. (24"x24") rect.



J83759 Lappato/Semipolished
30x60 rett. (12"x24") rect.

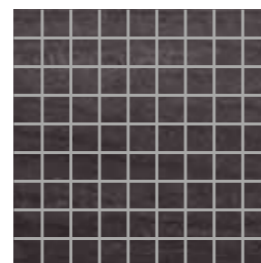

J83766 - Mos. Anthracite
30x30 (12"x12")

grey



J84029
60,5x60,5 (24"x24")



J83701
30,5x60,5 (12"x24")



J84032
60x60 rett. (24"x24") rect.



J83705
30x60 rett. (12"x24") rect.



J84035 Lappato/Semipolished
60x60 rett. (24"x24") rect.



J83760 Lappato/Semipolished
30x60 rett. (12"x24") rect.

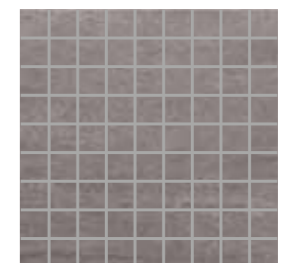

J83767 - Mosaico Grey
30x30 (12"x12")

silver



J84030
60,5x60,5 (24"x24")



J83703
30,5x60,5 (12"x24")



J84033
60x60 rett. (24"x24") rect.



J83706
30x60 rett. (12"x24") rect.



J84036 Lappato/Semipolished
60x60 rett. (24"x24") rect.



J83761 Lappato/Semipolished
30x60 rett. (12"x24") rect.

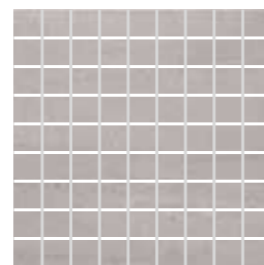

J83768 - Mosaico Silver
30x30 (12"x12")

white



J85127
60,5x60,5 (24"x24")



J84569
30,5x60,5 (12"x24")



J85128
60x60 rett. (24"x24") rect.



J84570
30x60 rett. (12"x24") rect.



J85151 Lappato/Semipolished
60x60 rett. (24"x24") rect.



J84571 Lappato/Semipolished
30x60 rett. (12"x24") rect.

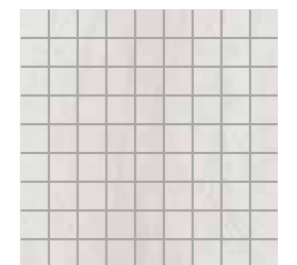

J84572 - Mosaico White
30x30 (12"x12")

ivory



J83702
30,5x60,5 (12"x24")

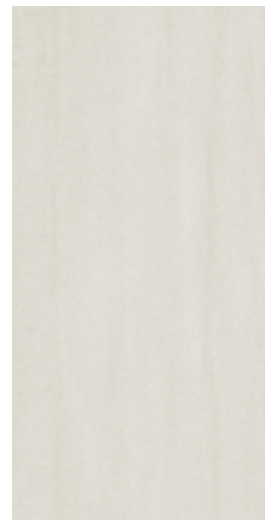

J83707
30x60 rett. (12"x24") rett.



J83762 Lappato/Semipolished
30x60 rett. (12"x24") rett.

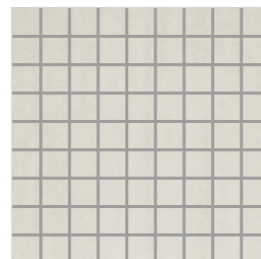

J83769 - Mosaico Ivory
30x30 (12"x12")

	60,5x60,5 (24"x24")	60x60 rett. (24"x24") rett.	60x60 rett. (24"x24") rett. Lappato/Semipol.	30,5x60,5 (12"x24")	30x60 rett. (12"x24") rett.	30x60 rett. (12"x24") rett. Lappato/Semipol.
● ANTHRACITE	J84028	J84031	J84034	J83700	J83704	J83759
● GREY	J84029	J84032	J84035	J83701	J83705	J83760
● SILVER	J84030	J84033	J84036	J83703	J83706	J83761
● WHITE	J85127	J85128	J85151	J84569	J84570	J84571
● IVORY	-	-	-	J83702	J83707	J83762
SPESSORE THICKNESS	9,5 mm	9,5 mm	9,5 mm	9,5 mm	9,5 mm	9,5 mm
KG/M²	21,82	21,85	21,85	20,00	20,37	20,37
PZ/BOX	3	3	3	6	6	6
M²/BOX	1,10	1,08	1,08	1,11	1,08	1,08
BOX/PALLET	40	40	40	48	48	48
M²/PALLET	44	43,20	43,20	53,28	51,84	51,84
KG/PALLET	960	944	944	1065,6	1056	1056
€ < 1 PALLET	48,00/m²	54,00/m²	63,30/m²	42,00/m²	48,00/m²	60,00/m²
€ > 1 PALLET	40,00/m²	45,00/m²	55,00/m²	35,00/m²	40,00/m²	50,00/m²

	Mosaico 30x30 (12"x12")	Battiscopa 7x30,5 (2 1/8"x12")	Gradino+Toro 30,5x30,5 (12"x12")	Angolo+Toro 30,5x30,5 (12"x12")
● ANTHRACITE	J83766	J83716	J83708	J83712
● GREY	J83767	J83717	J83709	J83713
● SILVER	J83768	J83718	J83710	J83714
● WHITE	J84572	J84575	J84573	J84574
● IVORY	J83769	J83719	J83711	J83715
PZ/BOX	6	12	6	2
€/UM	154,50/m²	4,50 pz/pce	31,30 pz/pce	60,20 pz/pce

Contributo spese imballo € 10,00/pal (netto). - Packing charges € 10,00/pal (net)





floor
Emilia - Multicolor Arco Bianco 60x60

[Back to Index](#)

EMILIA

Designed and registered by Rondine

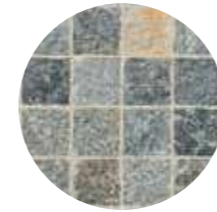

MULTICOLOR



PIETRE & MARMI

GRES PORCELLANATO A IMPASTO COLORATO
FULL BODY PORCELAIN STONEWARE
GRES CERAME A PATE COLOREE
DURCHGEFÄRBTES FEINSTEINZEUG

Coordinato con:
Coordinated with:
LE CAVE
SEZ. PIETRE E MARMI
PG. 381



20 mm

h20

SMART
EDGE



60x60 rett.
24"x24" rect.



60,5x60,5
24"x24"

9,5 mm



60,5x60,5
24"x24"

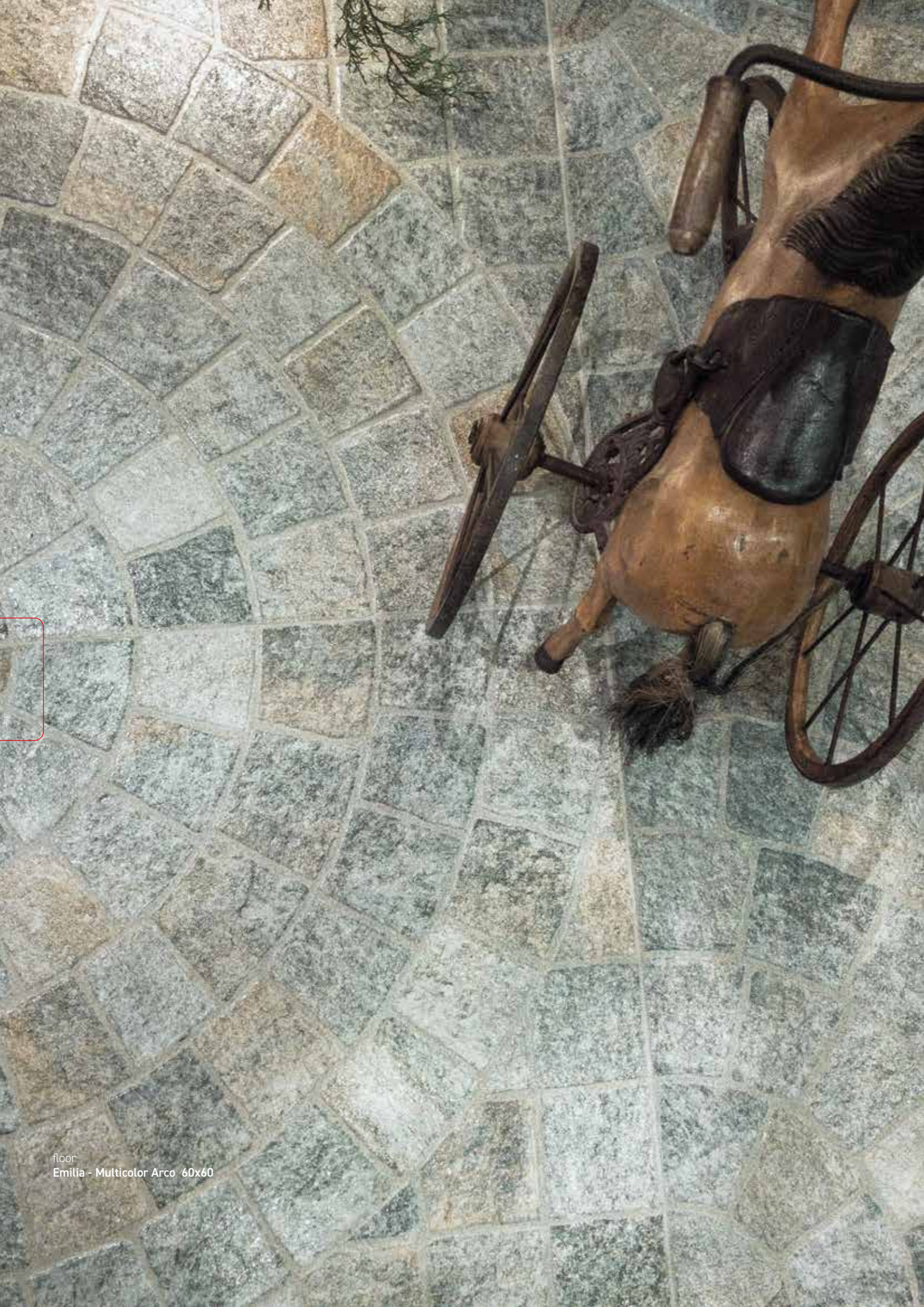

floor
Emilia - Multicolor Arco 60x60

multicolor lineare



9,5 mm **J88234** 60,5x60,5 (24"x24")

20 mm **J88169** 60x60 rett.(24"x24") rect. [h20](#)

20 mm **J88301** 60,5x60,5 (24"x24") Smart Edge [h20](#)

Disponibili pezzi speciali H20 a pag. 683

multicolor arco



9,5 mm **J88232** 60,5x60,5 (24"x24")

20 mm **J88167** 60x60 rett.(24"x24") rect. [h20](#)

20 mm **J88299** 60,5x60,5 (24"x24") Smart Edge [h20](#)

Disponibili pezzi speciali H20 a pag. 683

multicolor arco bianco



9,5 mm **J88233** 60,5x60,5 (24"x24")

20 mm **J88168** 60x60 rett.(24"x24") rect. [h20](#)

20 mm **J88300** 60,5x60,5 (24"x24") Smart Edge [h20](#)

Disponibili pezzi speciali H20 a pag. 683

multicolor lineare sviluppo grafico 60,5x60,5 (24"x24")





720 TOZZETTI

GRAFICHE DIVERSE
DIFFERENT PATTERNS
DIFFÉRENTS MOTIFS
VERSCHIEDENE MUSTER

20 60x60

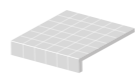
GRAFICHE DIVERSE
DIFFERENT PATTERNS
DIFFÉRENTS MOTIFS
VERSCHIEDENE MUSTER

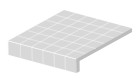
		 SP	 h20	 h20	 h20 SP
	60,5x60,5 (24"x24")	Elemento a L incollato 60,5x60,5x10 (24"x24"x4")	60,5x60,5 Smart Edge (24"x24") Smart Edge	60x60 rett. (24"x24") rect.	Elemento a L incollato - h20 60x60x10 rett. (24"x24"x4") rect.
MULTICOLOR					
ARCO	J88232	-	J88299	J88167	-
ARCO BIANCO	J88233	-	J88300	J88168	-
LINEARE	J88234	J88355	J88301	J88169	J88356
SPESSORE THICKNESS	9,5 mm	9,5 mm	20 mm	20 mm	20 mm
KG/M²	20,18	-	43,15	43,19	-
PZ/BOX	3	1	2	2	1
M²/BOX	1,10	-	0,73	0,72	-
BOX/PALLET	40	-	32	32	-
M²/PALLET	44,00	-	23,36	23,04	-
KG/PALLET	888	-	1008	995,2	-
€ <1 PALLET	54,00/m²	50,00 pz/pce	80,00/m²	84,00/m²	88,00 pz/pce
€ >1 PALLET	45,00/m²	50,00 pz/pce	69,50/m²	73,00/m²	88,00 pz/pce

Contributo spese imballo € 10,00/pal (netto). - Packing charges € 10,00/pal (net)



0,1%



A • HA • LA



OK



sp.10 mm > 45 N/mm²
sp.20 mm > 55 N/mm²



8



5

h20



>150 N/mm²



Dcof: Wet 0,72
Pendulum:
Dry 55 • Wet 47



V3



[Back to Index](#)

LE CAVE

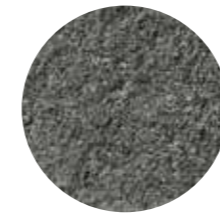

GRANITO
GRAFITE

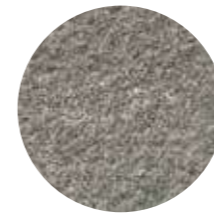

ONSERNONE
GRIGIO



LUSERNA
MULTICOLOR



BARGE
BEIGE



PORFIDO
BRUNO



**PIETRE
&
MARM**

GRES PORCELLANATO A IMPASTO COLORATO
FULL BODY PORCELAIN STONEWARE
GRES CERAME A PATE COLOREE
DURCHGEFÄRBTES FEINSTEINZEUG

Coordinato con:
Coordinated with:
ASIAGO
SEZ. 3D
PG. 93

AURELIA PG. 333
EMILIA PG. 375
VALERIA PG. 449
SEZ. PIETRE E MARM



20 mm

h20

9,5 mm

9 mm



40x120 rett.
16"x48" rect.

SMART
EDGE



20x30
8"x12"

SMART
EDGE



20x20
8"x8"



30,5x60,5
12"x24"



40,6x40,6
16"x16"



20,3x40,6
8"x16"



20,3x20,3
8"x8"

floor
Le Cave - Granito Grafite 20x30 - 20x20



onsernone grigio

9,5 mm



J88537
30,5x60,5 (12"x24")

9 mm



J88917
40,6x40,6 (16"x16")



J88534
20,3x40,6 (8"x16")



J88531
20,3x20,3 (8"x8")

granito grafite

20 mm



J88527
40x120 rett. (16"x48") rect.

Disponibili pezzi speciali H20 a pag. 680

h20



J88806
20x30 (8"x12") Smart Edge

h20



J88802
20x20 (8"x8") Smart Edge

20 mm



J88528
40x120 rett. (16"x48") rect.

Disponibili pezzi speciali H20 a pag. 680

h20



J88807
20x30 (8"x12") Smart Edge

h20



J88803
20x20 (8"x8") Smart Edge

luserna multicolor

OUT R11
c

9,5 mm



J88538
30,5x60,5 (12"x24")

9 mm



J88916
40,6x40,6 (16"x16")



J88535
20,3x40,6 (8"x16")



J88532
20,3x20,3 (8"x8")

barge beige

OUT R11
c

9,5 mm

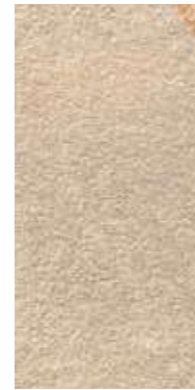

J88536
30,5x60,5 (12"x24")

9 mm



J88915
40,6x40,6 (16"x16")



J88533
20,3x40,6 (8"x16")



J88530
20,3x20,3 (8"x8")

20 mm



J88529
40x120 rett. (16"x48") rect.

Disponibili pezzi speciali H20 a pag. 680

h20



J88808
20x30 (8"x12") Smart Edge

h20



J88804
20x20 (8"x8") Smart Edge

20 mm



J88526
40x120 rett. (16"x48") rect.

Disponibili pezzi speciali H20 a pag. 680

h20



J88805
20x30 (8"x12") Smart Edge

h20



J88801
20x20 (8"x8") Smart Edge

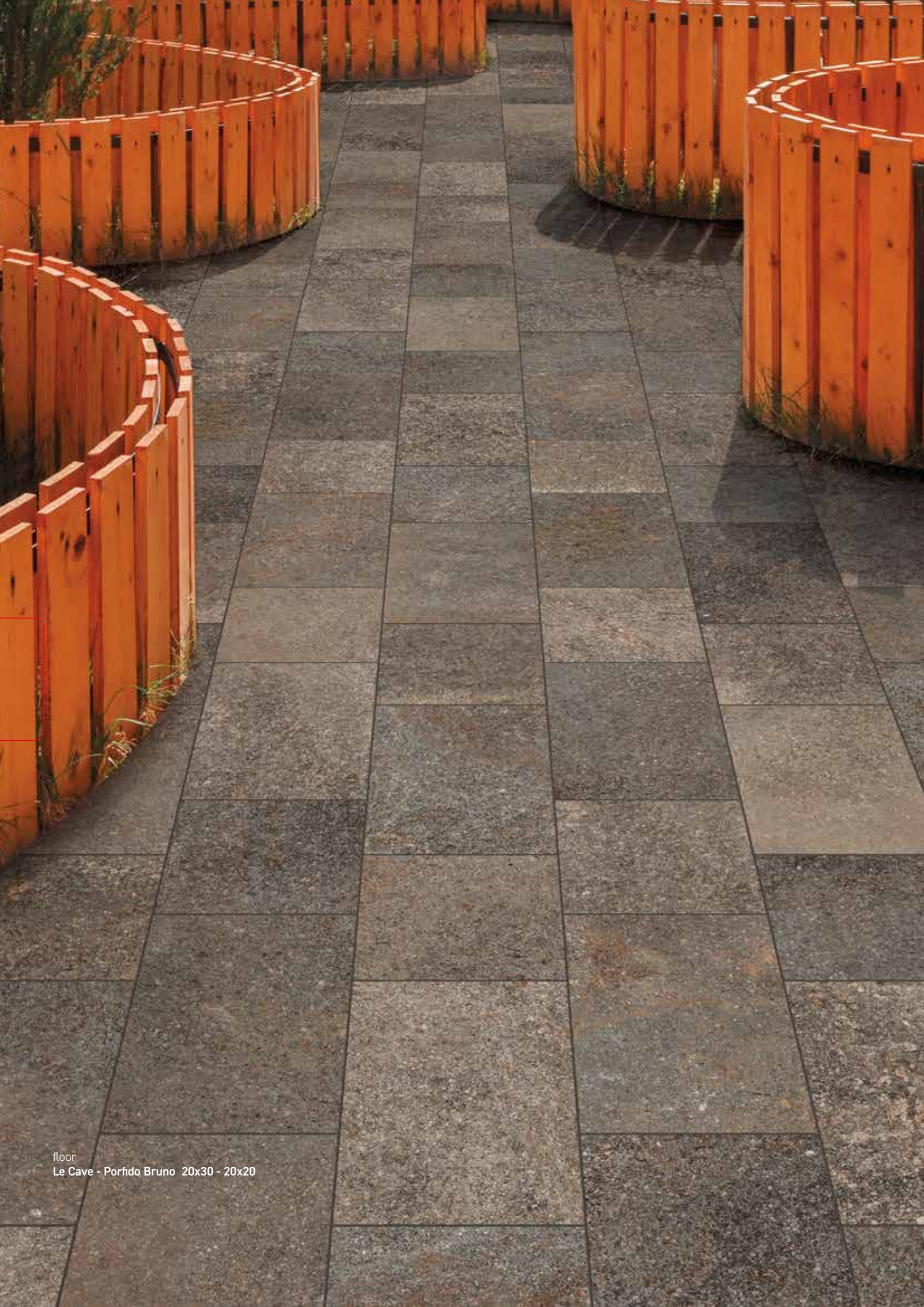

floor
Le Cave - Porfido Bruno 20x30 - 20x20

porfido bruno

h20

20 mm



J88539
40x120 rett. (16"x48") rect.

Disponibili pezzi speciali H20 a pag. 680

h20



J88810
20x30 (8"x12") Smart Edge

h20

















J88809
20x20 (8"x8") Smart Edge

barge beige lineare sviluppo grafico 40x120 rett. (16"x48") rett.



- 100** 20x20 h20
GRAFICHE DIVERSE
DIFFERENT PATTERNS
DIFFÉRENTS MOTIFS
VERSCHIEDENE MUSTER
- 70** 20x30 h20
GRAFICHE DIVERSE
DIFFERENT PATTERNS
DIFFÉRENTS MOTIFS
VERSCHIEDENE MUSTER
- 24** 40x120 h20
GRAFICHE DIVERSE
DIFFERENT PATTERNS
DIFFÉRENTS MOTIFS
VERSCHIEDENE MUSTER
- 150** 20,3x20,3
GRAFICHE DIVERSE
DIFFERENT PATTERNS
DIFFÉRENTS MOTIFS
VERSCHIEDENE MUSTER
- 75** 20,3x40,6
GRAFICHE DIVERSE
DIFFERENT PATTERNS
DIFFÉRENTS MOTIFS
VERSCHIEDENE MUSTER
- 75** 40,6x40,6
GRAFICHE DIVERSE
DIFFERENT PATTERNS
DIFFÉRENTS MOTIFS
VERSCHIEDENE MUSTER
- 50** 30,5x60,5
GRAFICHE DIVERSE
DIFFERENT PATTERNS
DIFFÉRENTS MOTIFS
VERSCHIEDENE MUSTER

							
	30,5x60,5 (12"x24")	40,6x40,6 (16"x16")	20,3x40,6 (8"x16")	20,3x20,3 (8"x8")	h20 40x120 rett. (16"x48") rett.	h20 20x30 Smart Edge (8"x12") Smart Edge	h20 20x20 Smart Edge (8"x8") Smart Edge
GRANITO GRAFITE	-	-	-	-	J88527	J88806	J88802
ONSERNONE GRIGIO	J88537	J88917	J88534	J88531	J88528	J88807	J88803
LUSERNA MULTICOLOR	J88538	J88916	J88535	J88532	J88529	J88808	J88804
BARGE BEIGE	J88536	J88915	J88533	J88530	J88526	J88805	J88801
PORFIDO BRUNO	-	-	-	-	J88539	J88810	J88809
SPESSORE THICKNESS	9,5 mm	9 mm	9 mm	9 mm	20 mm	20 mm	20 mm
KG/M²	17,93	17,37	19,00	18,10	46,46	40,37	40,77
PZ/BOX	6	6	13	30	1	9	13
M²/BOX	1,11	0,99	1,07	1,24	0,48	0,54	0,52
BOX/PALLET	48	72	72	60	48	64	68
M²/PALLET	53,28	71,28	77,04	74,40	23,04	34,56	35,36
KG/PALLET	955,68	1238,4	1463,76	1347	1070,4	1395,2	1441,6
€ <1 PALLET	42,00/m²	42,00/m²	42,00/m²	42,00/m²	107,00/m²	114,50/m²	114,50/m²
€ >1 PALLET	35,00/m²	35,00/m²	35,00/m²	35,00/m²	93,00/m²	99,50/m²	99,50/m²

							
	Battiscopa 8x45 (3 1/2"x18")	Elem. a L incollato 20,3x40,6x5 (8"x16"x2")	Elem. a L monolitico 15x30,5x4 (6"x12"x1 1/2")	Gradino+Toro 40,6x40,6 (16"x16")	Angolo+Toro 40,6x40,6 (16"x16")	Elem. a L incollato 40x120x5 rett. (16"x48"x2") rett.	Griglia 20x30 (8"x12")
GRANITO GRAFITE	-	-	-	-	-	J88966	J89154
ONSERNONE GRIGIO	J88925	J88928	J89201	J88931	J88934	J88968	J89156
LUSERNA MULTICOLOR	J88924	J88927	J89200	J88930	J88933	J88967	J89155
BARGE BEIGE	J88923	J88926	J89199	J88929	J88932	J88965	J89153
PORFIDO BRUNO	-	-	-	-	-	J88969	J89157
PZ/BOX	30	8	8	6	2	1	6
€/UM	5,40/ml	16,40 pz/pce	16,40 pz/pce	45,00 pz/pce	86,50 pz/pce	225,00 pz/pce	65,00 pz/pce

Contributo spese imballo € 10,00/pal (netto). - Packing charges € 10,00/pal (net)



0,10%



A • HA • LA



OK



sp.9 mm > 40 N/mm²
sp.20 mm > 45 N/mm²



7



5



h20
<140 N/mm²



R11
C

Dcof: Wet 0,55
Pendulum:
Dry 56 • Wet 37



h20
R11
C

Dcof: Wet 0,72
Pendulum:
Dry 55 • Wet 47



V3



floor
Piasentina - Naturale 30,5x60,5

PIASENTINA

[Back to Index](#)

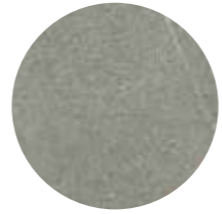

NATURALE

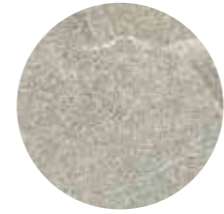

FIAMMATA



GRES PORCELLANATO A IMPASTO COLORATO
FULL BODY PORCELAIN STONEWARE
GRES CERAME A PATE COLOREE
DURCHGEFÄRBTES FEINSTEINZEUG



30,5x60,5
12"x24"

IN OUT R10
B

naturale



J88228
30,5x60,5 (12"x24")

fiammata







J88227
30,5x60,5 (12"x24")

naturale sviluppo grafico 60x120 (24"x48")

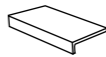
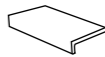

30 30,5x60,5

GRAFICHE DIVERSE
DIFFERENT PATTERNS
DIFFÉRENTS MOTIFS
VERSCHIEDENE MUSTER

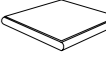
			 SP	 SP	 SP	 SP
	30,5x60,5 (12"x24")	Battiscopa 7,5x60,5 (3"x24")	Elemento a L incollato 15x30,5x5 (6"x12"x2")	Elemento a L monolitico 15x30,5x4 (6"x12"x1 1/2")	Gradino+Toro 30,5x30,5 (12"x12")	Angolo+Toro 30,5x30,5 (12"x12")
NATURALE	J88228	J88338	J88340	J88342	J88344	J88346
FIAMMATA	J88227	J88337	J88339	J88341	J88343	J88345
SPESSORE THICKNESS	9,5 mm	-	-	9,5 mm	-	-
KG/M²	18,93	-	-	-	-	-
PZ/BOX	6	12	8	8	6	2
M²/BOX	1,11	-	-	-	-	-
BOX/PALLET	48	-	-	-	-	-
M²/PALLET	53,28	-	-	-	-	-
KG/PALLET	1009	-	-	-	-	-
€ <1 PALLET	42,00/m²	9,30 pz/pce	14,40 pz/pce	16,40 pz/pce	31,30 pz/pce	60,20 pz/pce
€ >1 PALLET	35,00/m²	9,30 pz/pce	14,40 pz/pce	16,40 pz/pce	31,30 pz/pce	60,20 pz/pce

Contributo spese imballo € 10,00/pal (netto). - Packing charges € 10,00/pal (net)



0,06%



A · HA · LA



OK



56,6 N/mm²



8



5



Classe V



Dcof: Wet 0,61
Pendulum:
Dry 53 · Wet 34



V3



wall
Pietra di Panama - Mosaico Dark 30x30

floor
Pietra di Panama - Dark 60x120 Full Lapp.

[Back to Index](#)

PIETRA DI PANAMA

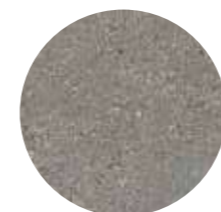

DARK



GREY

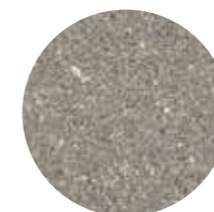

TAUPE

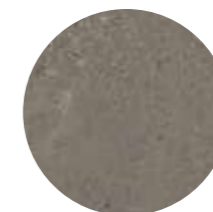

BROWN



PIETRE & MARMI

GRES PORCELLANATO A IMPASTO COLORATO
FULL BODY PORCELAIN STONEWARE
GRES CERAME A PATE COLOREE
DURCHGEFÄRBTES FEINSTEINZEUG

OUT 9,5 mm

IN 9,5 mm

NATURALE / NATURAL
LAPPATO / SEMIPOLISHED

STRONG



30,5x60,5
12"x24"



60x120 rett.
24"x48" rect.



20x120 rett.
8"x48" rect.



30x60 rett.
12"x24" rect.

dark

IN R10
B

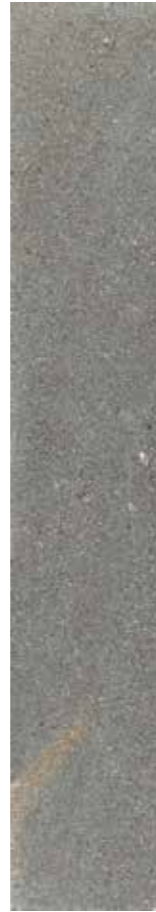

J87703
60x120 rett. (24"x48") rect.

J87707
20x120 rett. (8"x48") rect.

J88224 Full Lappato/Polished
60x120 rett. (24"x48") rect.

3



J87723
30x60 rett. (12"x24") rect.



J87719
30,5x60,5 (12"x24")

OUT STRONG
R11
C



J87711 STRONG
30,5x60,5 (12"x24")

grey

IN R10
B



J87704
60x120 rett. (24"x48") rect.

J87708
20x120 rett. (8"x48") rect.

J88225 Full Lappato/Polished
60x120 rett. (24"x48") rect.

4



J87724
30x60 rett. (12"x24") rect.



J87720
30,5x60,5 (12"x24")

OUT STRONG
R11
C



J87712 STRONG
30,5x60,5 (12"x24")

taupe

IN R10
B



J87705
60x120 rett. (24"x48") rect.

J87709
20x120 rett. (8"x48") rect.

J88226 Full Lappato/Polished
60x120 rett. (24"x48") rect.

4



J87725
30x60 rett. (12"x24") rect.



J87721
30,5x60,5 (12"x24")

OUT STRONG
R11
C



J87713 STRONG
30,5x60,5 (12"x24")

brown

IN R10
B



J87797
60x120 rett. (24"x48") rect.

J87798
20x120 rett. (8"x48") rect.

J88223 Full Lappato/Polished
60x120 rett. (24"x48") rect.

3



J87802
30x60 rett. (12"x24") rect.



J87801
30,5x60,5 (12"x24")

OUT STRONG
R11
C



J87799 STRONG
30,5x60,5 (12"x24")

PIETRA DI PANAMA



floor
Pietra di Panama - Grey 60x120

dark

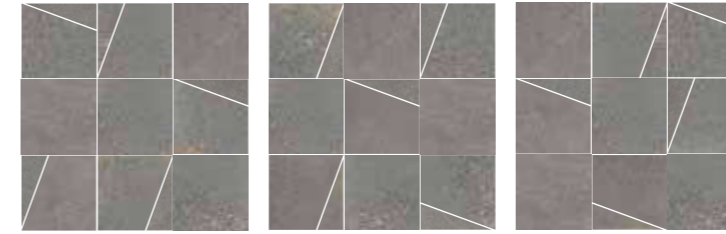

J88109 Mosaico Trapezi
30x30 (12"x12")

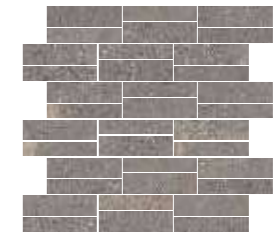

J88113 Mosaico
30x30 (12"x12")

grey

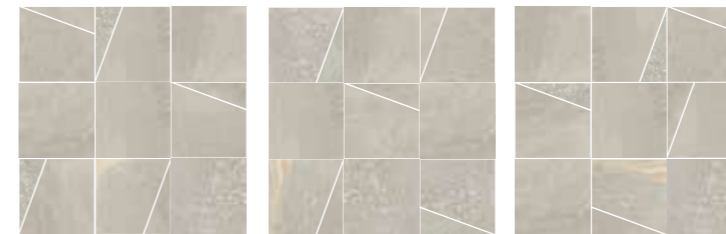

J88110 Mosaico Trapezi
30x30 (12"x12")



J88114 Mosaico
30x30 (12"x12")

taupe

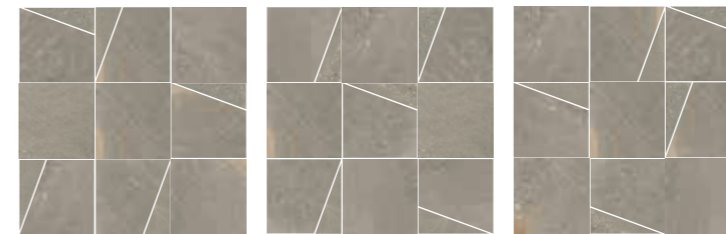

J88111 Mosaico Trapezi
30x30 (12"x12")

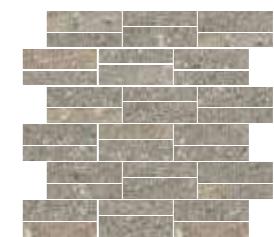

J88115 Mosaico
30x30 (12"x12")

brown

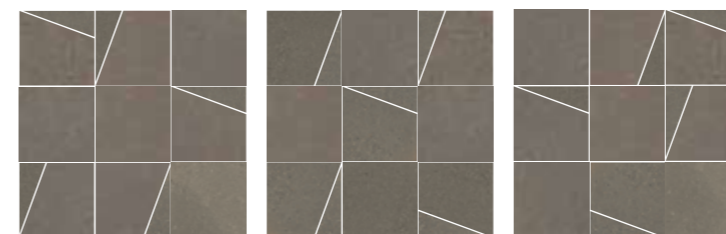

J88108 Mosaico Trapezi
30x30 (12"x12")



J88112 Mosaico
30x30 (12"x12")

brown sviluppo grafico 30x60 rett. (12"x24") rect.



10 60x120

GRAFICHE DIVERSE
DIFFERENT PATTERNS
DIFFÉRENTS MOTIFS
VERSCHIEDENE MUSTER

30 20x120

GRAFICHE DIVERSE
DIFFERENT PATTERNS
DIFFÉRENTS MOTIFS
VERSCHIEDENE MUSTER

30 30x60

GRAFICHE DIVERSE
DIFFERENT PATTERNS
DIFFÉRENTS MOTIFS
VERSCHIEDENE MUSTER

	60x120 rett. (24"x48") rect.	Full Lappato/Polished 60x120 rett. (24"x48") rect.	20x120 rett. (8"x48") rect.	30x60 rett. (12"x24") rect.	30,5x60,5 (12"x24")	STRONG 30,5x60,5 (12"x24")	Mosaico Trapezi 30x30 (12"x12")	Mosaico 30x30 (12"x12")
DARK	J87703	J88224	J87707	J87723	J87719	J87711	J88109	J88113
GREY	J87704	J88225	J87708	J87724	J87720	J87712	J88110	J88114
TAUPE	J87705	J88226	J87709	J87725	J87721	J87713	J88111	J88115
BROWN	J87797	J88223	J87798	J87802	J87801	J87799	J88108	J88112
SPESSORE THICKNESS	9,5 mm	9,5 mm	9,5 mm	9,5 mm	9,5 mm	9,5 mm	-	-
KG/M²	21,54	21,39	21,48	19,69	18,99	18,99	-	-
PZ/BOX	2	2	4	6	6	6	6	6
M²/BOX	1,44	1,44	0,96	1,08	1,11	1,11	-	-
BOX/PALLET	32	36	48	48	48	48	-	-
M²/PALLET	46,08	51,84	46,08	51,84	53,28	53,28	-	-
KG/PALLET	992,64	1108,8	990,24	1020,96	1011,8	1011,8	-	-
€ <1 PALLET	65,00/m²	92,00/m²	68,70/m²	46,10/m²	42,00/m²	46,10/m²	171,00/m²	191,00/m²
€ >1 PALLET	56,50/m²	80,00/m²	59,70/m²	38,40/m²	35,00/m²	38,40/m²	171,00/m²	191,00/m²

	Battiscopa 7,5x60 (3"x24")	Gradino+Toro 33x120x4 (13"x48"x1 1/2")	Angolo+Toro Dx 33x120x4 (13"x48"x1 1/2")	Angolo+Toro Sx 33x120x4 (13"x48"x1 1/2")	Battiscopa Lappato 7,5x60 (3"x24")	Gradino+Toro Lapp. 33x120x4 (13"x48"x1 1/2")	Angolo+Toro Dx Lapp. 33x120x4 (13"x48"x1 1/2")	Angolo+Toro Sx Lapp. 33x120x4 (13"x48"x1 1/2")
DARK	J88270	J88723	J88727	J88731	J88274	J88735	J88739	J88743
GREY	J88271	J88725	J88728	J88732	J88275	J88736	J88740	J88744
TAUPE	J88272	J88725	J88729	J88733	J88276	J88737	J88741	J88745
BROWN	J88269	J88722	J88726	J88730	J88273	J88734	J88738	J88742
PZ/BOX	12	2	1	1	12	2	1	1
€/UM	9,30 pz/pce	179,00 pz/pce	239,00 pz/pce	239,00 pz/pce	12,00 pz/pce	195,00 pz/pce	254,00 pz/pce	254,00 pz/pce

Contributo spese imballo € 10,00/pal (netto). - Packing charges € 10,00/pal (net)

0,10%
 A • HA • LA
 OK
 > 45 N/mm²
 6
 5
 Classe IV
 Classe V
 R10 B
 R11 C
 V4

 Dcof: Wet 0,65 Pendulum: Dry 45 • Wet 36
 Dcof: Wet 0,72 Pendulum: Dry 59 • Wet 37



wall
Pietre di Fiume - Mosaico Mix Antracite 30x30

floor
Pietre di Fiume - Grigio 60x120

[Back to Index](#)

PIETRE DI FIUME



ANTRACITE



GRIGIO



BEIGE

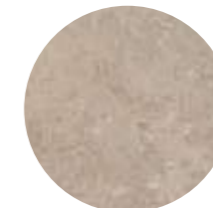

TORTORA



GRES PORCELLANATO A IMPASTO COLORATO
FULL BODY PORCELAIN STONEWARE
GRES CERAME A PATE COLOREE
DURCHGEFÄRBTES FEINSTEINZEUG

OUT 9,5 mm

IN 9,5 mm



60x60 rett.
24"x24" rect.



60x120 rett.
24"x48" rect.

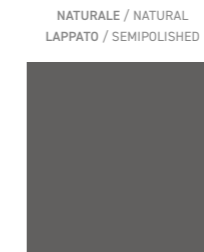

60x60 rett.
24"x24" rect.



30x60 rett.
12"x24" rect.



30,5x60,5
12"x24"

antracite

IN R10
A



J86314
60x120 rett. (24"x48") rect.



J86322
30x60 rett. (12"x24") rect.



J86318
30,5x60,5 (12"x24")



J86306
60x60 rett. (24"x24") rect.



J86661 Lappato/Semipolished
60x60 rett. (24"x24") rect. 4



J86874 Mosaico
30x30 (12"x12")

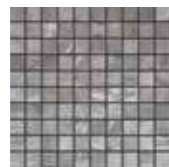

J86882 Mosaico Mix
30x30 (12"x12")



J86878 Muretto
30x60 (12"x24")

OUT STRONG
R11
C



J86866 STRONG
60x60 rett. (24"x24") rect.

grigio

IN R10
A



J86313
60x120 rett. (24"x48") rect.



J86321
30x60 rett. (12"x24") rect.



J86317
30,5x60,5 (12"x24")



J86305
60x60 rett. (24"x24") rect.



J86660 Lappato/Semipolished
60x60 rett. (24"x24") rect. 4



J86873 Mosaico
30x30 (12"x12")



J86881 Mosaico Mix
30x30 (12"x12")



J86877 Muretto
30x60 (12"x24")

OUT STRONG
R11
C



J86865 STRONG
60x60 rett. (24"x24") rect.

beige

IN R10/A



J86312
60x120 rett. (24"x48") rect.



J86320
30x60 rett. (12"x24") rect.



J86316
30,5x60,5 (12"x24")

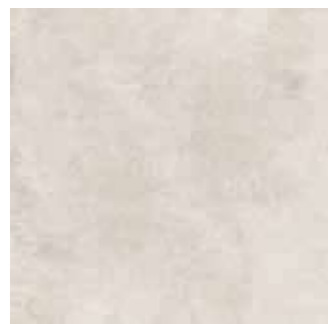

J86303
60x60 rett. (24"x24") rect.



J86659 Lappato/Semipolished 4
60x60 rett. (24"x24") rect.



J86872 Mosaico
30x30 (12"x12")



J86880 Mosaico Mix
30x30 (12"x12")



J86876 Muretto
30x60 (12"x24")

OUT STRONG R11/C

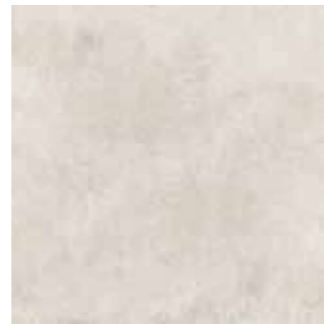

J86864 STRONG
60x60 rett. (24"x24") rect.

tortora

IN R10/A



J86315
60x120 rett. (24"x48") rect.



J86323
30x60 rett. (12"x24") rect.



J86319
30,5x60,5 (12"x24")



J86307
60x60 rett. (24"x24") rect.



J86662 Lappato/Semipolished 4
60x60 rett. (24"x24") rect.

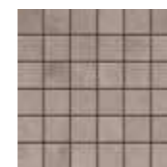

J86875 Mosaico
30x30 (12"x12")



J86883 Mosaico Mix
30x30 (12"x12")



J86879 Muretto
30x60 (12"x24")

OUT STRONG R11/C



J86867 STRONG
60x60 rett. (24"x24") rect.

tortora sviluppo grafico 60x60 rett. (12"x12") rett.



12 60x120

GRAFICHE DIVERSE
DIFFERENT PATTERNS
DIFFÉRENTS MOTIFS
VERSCHIEDENE MUSTER

24 60x60

GRAFICHE DIVERSE
DIFFERENT PATTERNS
DIFFÉRENTS MOTIFS
VERSCHIEDENE MUSTER

48 30x60

GRAFICHE DIVERSE
DIFFERENT PATTERNS
DIFFÉRENTS MOTIFS
VERSCHIEDENE MUSTER

	60x120 rett. (24"x48") rect.	60x60 rett. (24"x24") rect.	Lappato/Semipolished 60x60 rett. (24"x24") rect.	STRONG 60x60 rett. (24"x24") rect.	30x60 rett. (12"x24") rect.	30,5x60,5 (12"x24")
ANTRACITE	J86314	J86306	J86661	J86866	J86322	J86318
GRIGIO	J86313	J86305	J86660	J86865	J86321	J86317
BEIGE	J86312	J86303	J86659	J86864	J86320	J86316
TORTORA	J86315	J86307	J86662	J86867	J86323	J86319
SPESSORE THICKNESS	9,5 mm	9,5 mm	9,5 mm	9,5 mm	9,5 mm	9,5 mm
KG/M²	23,47	20,9	20,9	20,9	19,37	19,37
PZ/BOX	2	3	3	3	6	6
M²/BOX	1,44	1,08	1,08	1,08	1,08	1,11
BOX/PALLET	32	40	40	40	48	48
M²/PALLET	46,08	43,20	43,20	43,20	51,84	53,28
KG/PALLET	1081,5	904	904	904	1004	1032
€ <1 PALLET	65,00/m²	54,00/m²	86,30/m²	57,60/m²	46,10/m²	42,00/m²
€ >1 PALLET	56,50/m²	45,00/m²	75,00/m²	48,00/m²	38,40/m²	35,00/m²

	Mosaico 30x30 (12"x12")	Mosaico Mix 30x30 (12"x12")	Muretto 30x60 (12"x24")	Battiscopa 7,5x60 (3"x24")	Gradino+Toro 33x120x4 (13"x48"x1 ½")	Angolo+Toro Dx 33x120x4 (13"x48"x1 ½")	Angolo+Toro Sx 33x120x4 (13"x48"x1 ½")
ANTRACITE	J86874	J86882	J86878	J86565	J86886	J86890	J86894
GRIGIO	J86873	J86881	J86877	J86564	J86885	J86889	J86893
BEIGE	J86872	J86880	J86876	J86563	J86884	J86888	J86892
TORTORA	J86875	J86883	J86879	J86566	J86887	J86891	J86895
PZ/BOX	6	6	4	12	2	1	1
€/UM	122,20/m²	245,00/m²	109,00/m²	9,30 pz/pce	179,00 pz/pce	239,00 pz/pce	239,00 pz/pce

Contributo spese imballo € 10,00/pal (netto). - Packing charges € 10,00/pal (net)

< 0,2% A · HA · LA OK > 45 N/mm² 6 5 Classe IV Classe V R10 A R11 C Dcof: Wet 0,54 Pendulum: Dry 56 · Wet 25 Dcof: Wet 0,66 Pendulum: Dry 46 · Wet 42 Antracite, Beige, Grigio, Tortora

PROVENCE

[Back to Index](#)

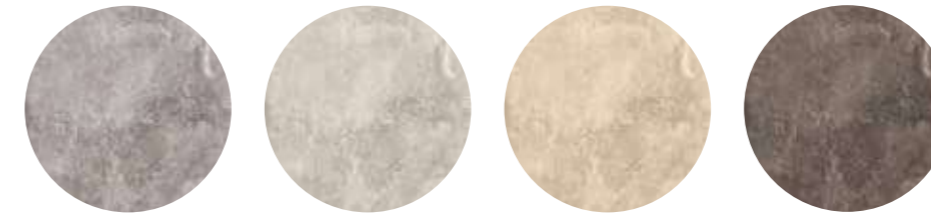

GREY

LIGHT GREY

CREAM

MULTICOLOR



GRES PORCELLANATO SMALTATO
GLAZED PORCELAIN STONEWARE
GRES CERAME EMAILLE
GLASIERTESFEINSTEINZEUG



60x100 rett.
24"x39 1/2" rect.



30,5x60,5
12"x24"

STRONG



20,3x40,6
8"x16"



20,3x20,3
8"x8"



100x100 rett.
39 1/2"x39 1/2" rect.



60x120 rett.
24"x48" rect.



60x60 rett.
24"x24" rect.



30x60 rett.
12"x24" rect.



floor
Provence - Grey 60x120

grey



J89578
100x100 rett. (39 1/4"x39 1/4") rect.



J89408
60x120 rett. (24"x48") rect.



J89416
60x60 rett. (24"x24") rect.



J89420
30x60 rett. (12"x24") rect.



J89586 Muretto
30x60 (12"x24")



J89582 Spaccatella
30x30 (12"x12")

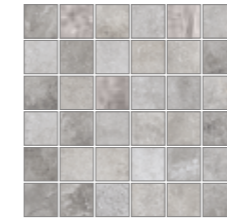

J89590 Mosaico
30x30 (12"x12")

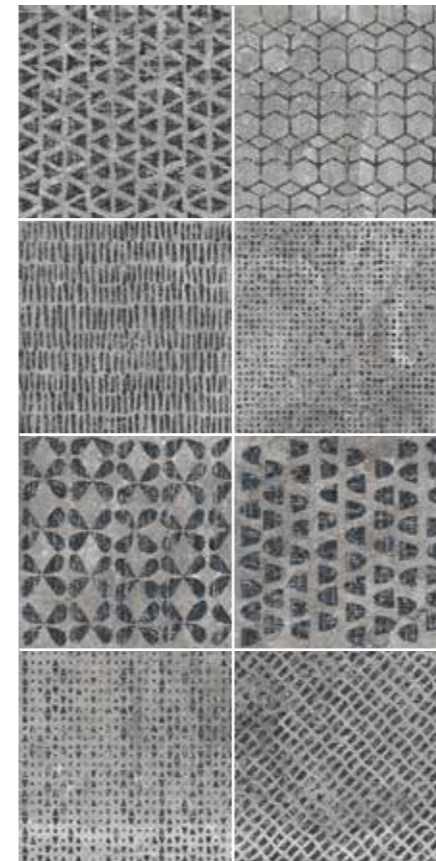

J89594 Metal Chic 8 pz.
30x30 (12"x12")



h20



J89542
60x100 rett. (24"x39 1/4") rect.

Disponibili pezzi speciali H20 a pag. 683



J89555 STRONG
30,5x60,5 (12"x24")



J89546 STRONG
20,3x40,6 (8"x16")



J89550 STRONG
20,3x20,3 (8"x8")

light grey



J89579
100x100 rett. (39 1/4"x39 1/4") rect.



J89409
60x120 rett. (24"x48") rect.



J89417
60x60 rett. (24"x24") rect.

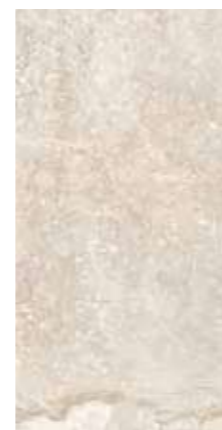

J89421
30x60 rett. (12"x24") rect.



J89587 Muretto
30x60 (12"x24")



J89583 Spaccatella
30x30 (12"x12")

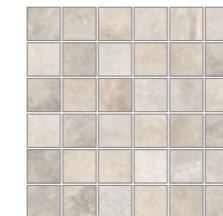

J89591 Mosaico
30x30 (12"x12")

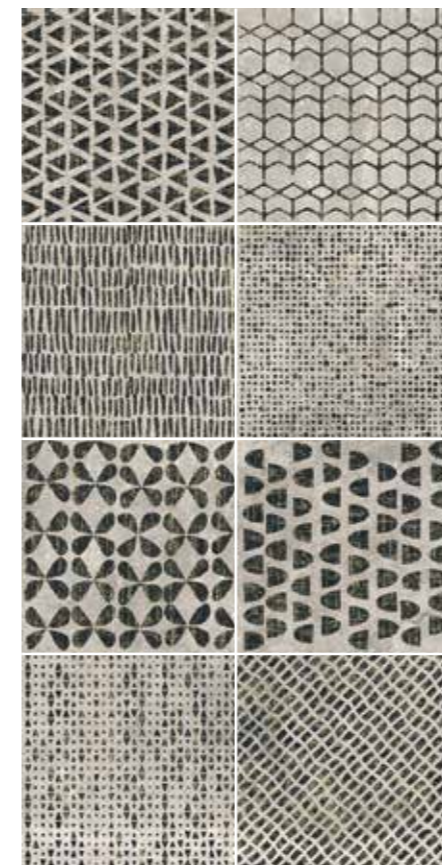

J89595 Metal Chic 8 pz.
30x30 (12"x12")



h20



J89543
60x100 rett. (24"x39 1/4") rect.
Disponibili pezzi speciali H20 a pag. 683



J89556 STRONG
30,5x60,5 (12"x24")



J89547 STRONG
20,3x40,6 (8"x16")



J89551 STRONG
20,3x20,3 (8"x8")

cream



J89577
100x100 rett. (39 1/4"x39 1/4") rect.



J89407
60x120 rett. (24"x48") rect.



J89415
60x60 rett. (24"x24") rect.

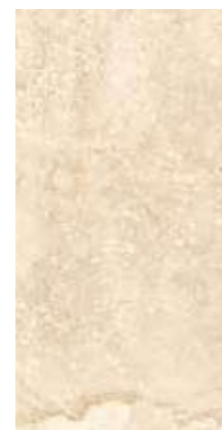

J89419
30x60 rett. (12"x24") rect.



J89585 Muretto
30x60 (12"x24")



J89581 Spaccatella
30x30 (12"x12")



J89589 Mosaico
30x30 (12"x12")

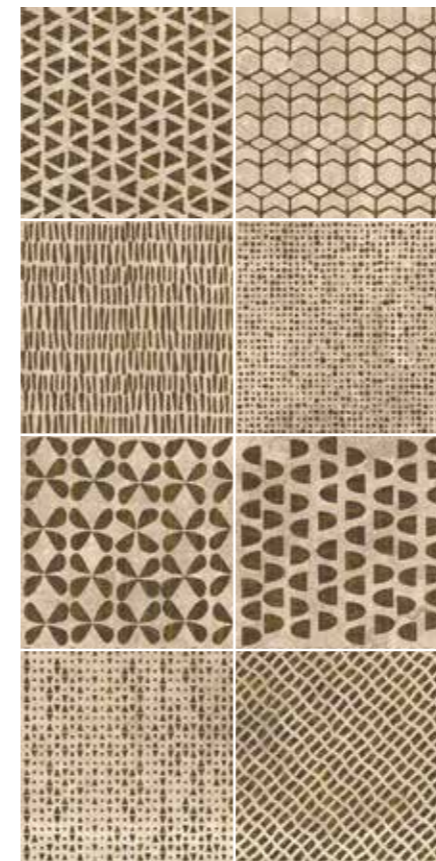

J89593 Metal Chic 8 pz.
30x30 (12"x12")



h20



J89541
60x100 rett. (24"x39 1/4") rect.
Disponibili pezzi speciali H20 a pag. 683



J89554 STRONG
30,5x60,5 (12"x24")



J89545 STRONG
20,3x40,6 (8"x16")



J89549 STRONG
20,3x20,3 (8"x8")

multicolor



J89580
100x100 rett. (39 1/4"x39 1/4") rect.



J89410
60x120 rett. (24"x48") rect.



J89418
60x60 rett. (24"x24") rect.



J89422
30x60 rett. (12"x24") rect.



J89588 Muretto
30x60 (12"x24")



J89584 Spaccatella
30x30 (12"x12")

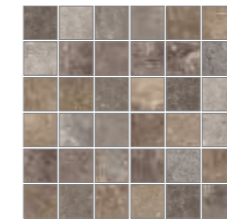

J89592 Mosaico
30x30 (12"x12")

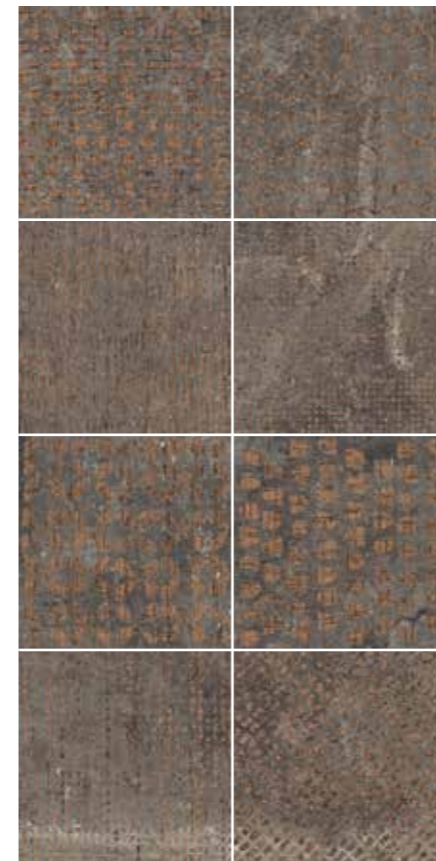

J89596 Metal Chic 8 pz.
30x30 (12"x12")



h20



J89544
60x100 rett. (24"x39 1/4") rect.
Disponibili pezzi speciali H20 a pag. 683



J89557 STRONG
30,5x60,5 (12"x24")

multicolor sviluppo grafico 60x120 (24"x48")



12 100x100

GRAFICHE DIVERSE
DIFFERENT PATTERNS
DIFFÉRENTS MOTIFS
VERSCHIEDENE MUSTER

17 60x120

GRAFICHE DIVERSE
DIFFERENT PATTERNS
DIFFÉRENTS MOTIFS
VERSCHIEDENE MUSTER

34 60x60

GRAFICHE DIVERSE
DIFFERENT PATTERNS
DIFFÉRENTS MOTIFS
VERSCHIEDENE MUSTER

68 30x60

GRAFICHE DIVERSE
DIFFERENT PATTERNS
DIFFÉRENTS MOTIFS
VERSCHIEDENE MUSTER

25 20,3x40,6

GRAFICHE DIVERSE
DIFFERENT PATTERNS
DIFFÉRENTS MOTIFS
VERSCHIEDENE MUSTER

50 20,3x20,3

GRAFICHE DIVERSE
DIFFERENT PATTERNS
DIFFÉRENTS MOTIFS
VERSCHIEDENE MUSTER

17 60x100 h20

GRAFICHE DIVERSE
DIFFERENT PATTERNS
DIFFÉRENTS MOTIFS
VERSCHIEDENE MUSTER

	60x100 rett. (24"x39 1/2") rect.	100x100 rett. (39 1/2"x39 1/2") rect.	60x120 rett. (24"x48") rect.	60x60 rett. (24"x24") rect.	30x60 rett. (12"x24") rect.	STRONG 30,5x60,5 (12"x24")	STRONG 20,3x40,6 rett. (8"x16") rect.	STRONG 20,3x20,3 (8"x8")
GREY	J89542	J89578	J89408	J89416	J89420	J89555	J89546	J89550
LIGHT GREY	J89543	J89579	J89409	J89417	J89421	J89556	J89547	J89551
CREAM	J89541	J89577	J89407	J89415	J89419	J89554	J89545	J89549
MULTICOLOR	J89544	J89580	J89410	J89418	J89422	J89557	-	-
SPESSORE THICKNESS	20 mm	8,5 mm	8,5 mm	8,5 mm	8,5 mm	8,5 mm	8,5 mm	8,5 mm
KG/M²	40,00	20,00	19,32	19,07	19,04	19,04	18,97	18,10
PZ/BOX	1	2	2	3	7	7	13	30
M²/BOX	0,60	2,00	1,44	1,08	1,26	1,29	1,07	1,24
BOX/PALLET	48	24	32	40	48	48	72	60
M²/PALLET	28,80	48,00	46,08	43,20	60,48	60,48	77,04	74,40
KG/PALLET	1152	960	890,56	824	1152	1152	1461,6	1347
€ <1 PALLET	107,00/m²	69,00/m²	65,00/m²	54,00/m²	46,10/m²	46,10/m²	39,60/m²	39,60/m²
€ >1 PALLET	93,00/m²	60,00/m²	56,50/m²	45,00/m²	38,40/m²	38,40/m²	33,00/m²	33,00/m²

	Mosaico 30x30 (12"x12")	Spaccatella 30x60 (12"x24")	Muretto 30x60 (12"x24")	Metal chic 8 pezzi 30x30 (12"x12")	Battiscopa 7,5x60 rett. (3"x24") rect.	Gradino + Toro 33x120x4 (13"x48"x1 1/2")	Angolo + Toro Dx 33x120x4 (13"x48"x1 1/2")	Angolo + Toro Sx 33x120 (13"x48")	Elem. a L monolitico 15,5x30x4 (6"x12"x1 1/2")
GREY	J89590	J89582	J89586	J89594	J89598	J89602	J89606	J89610	J89878
LIGHT GREY	J89591	J89583	J89587	J89595	J89599	J89603	J89607	J89611	J89879
CREAM	J89589	J89581	J89585	J89593	J89597	J89601	J89605	J89609	J89877
MULTICOLOR	J89592	J89584	J89588	J89596	J89600	J89604	J89608	J89612	-
SPESSORE THICKNESS	8,5 mm	8,5 mm	8,5 mm	8,5 mm	8,5 mm	8,5 mm	8,5 mm	8,5 mm	8,5 mm
KG/M²	17,60	-	-	-	-	-	-	-	-
PZ/BOX	6	6	4	8	12	2	1	1	8
M²/BOX	0,54	-	-	-	-	-	-	-	-
BOX/PALLET	60	-	-	-	-	-	-	-	-
M²/PALLET	32,40	-	-	-	-	-	-	-	-
KG/PALLET	570	-	-	-	-	-	-	-	-
€ <1 PALLET	140,20/m²	154,50/m²	122,20/m²	320,00 cp	9,30 pz/pce	179,00 pz/pce	239,00 pz/pce	239,00 pz/pce	16,40 pz/pce
€ >1 PALLET	140,20/m²	154,50/m²	122,20/m²	320,00 cp	9,30 pz/pce	179,00 pz/pce	239,00 pz/pce	239,00 pz/pce	16,40 pz/pce

Contributo spese imballo € 10,00/pal (netto). - Packing charges € 10,00/pal (net)

Contributo spese imballo € 20,00/pal (netto) per formato 100x100 sp. 8,5 mm - Packing charges € 20,00/pal (net) for size 100x100 th. 8,5 mm

0,1% A+ HA+ LA OK >45 N/mm² 7 5 Classe IV Classe V R10 B R11 C V4

Dcof: > 0,42 Pendulum: 25 < x < 35 Dcof: > 0,42 Pendulum: Dry/Wet > 36

QUARZI

[Back to Index](#)

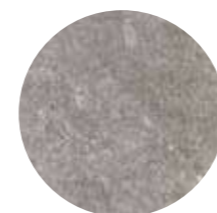

GREY



LIGHT GREY



WHITE

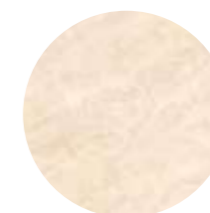

BEIGE



GRES PORCELLANATO A IMPASTO COLORATO
 FULL BODY PORCELAIN STONEWARE
 GRES CERAME A PATE COLOREE
 DURCHGEFÄRBTES FEINSTEINZEUG

Coordinato con:
 Coordinated with:
QUARZI 3D
 SEZ. 3D
 PG. 137



floor
 Quarzi - Light Grey 60x60
 Quarzi - Light Grey 20,3x40,6

OUT

9,5 mm

GRIP



30,5x60,5
 12"x24"

9 mm



20,3x40,6
 8"x16"



20,3x20,3
 8"x8"

IN

9,5 mm



60x60 rett.
 24"x24" rect.



60,5x60,5
 24"x24"



30x60 rett.
 12"x24" rect.



30,5x60,5
 12"x24"

grey

IN R10
C



J87287
60,5x60,5 (24"x24")



J87295
30,5x60,5 (12"x24")



J87291
60x60 rett. (24"x24") rect.



J87299
30x60 rett. (12"x24") rect.

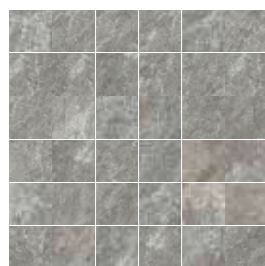

J87319 Mosaico
30x30 (12"x 12")



J87323 Muretto
30x60 (12"x 24")

OUT R11
C



J87616 GRIP
30,5x60,5 (12"x24")



J87315
20,3x40,6 (8"x16")



J87386
20,3x20,3 (8"x8")

light grey

IN R10
C



J87288
60,5x60,5 (24"x24")



J87296
30,5x60,5 (12"x24")



J87292
60x60 rett. (24"x24") rect.



J87300
30x60 rett. (12"x24") rect.



J87320 Mosaico
30x30 (12"x 12")

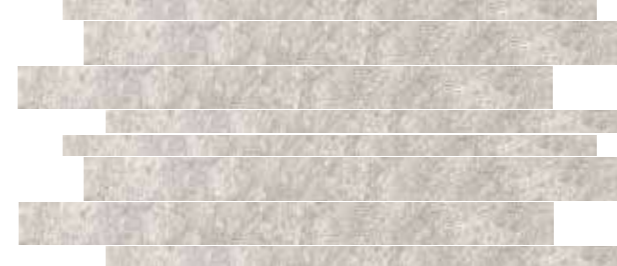

J87324 Muretto
30x60 (12"x 24")

OUT R11
C



J87617 GRIP
30,5x60,5 (12"x24")



J87316
20,3x40,6 (8"x16")



J87387
20,3x20,3 (8"x8")

white

IN R10
C



J87289
60,5x60,5 (24"x24")



J87297
30,5x60,5 (12"x24")



J87293
60x60 rett. (24"x24") rect.

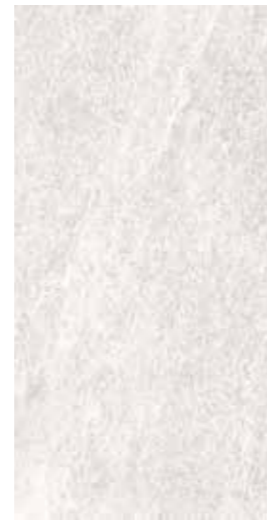

J87301
30x60 rett. (12"x24") rect.



J87321 Mosaico
30x30 (12"x 12")

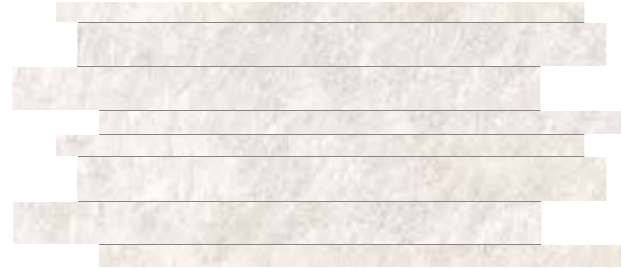

J87325 Muretto
30x60 (12"x 24")

OUT R11
C



J87618 GRIP
30,5x60,5 (12"x24")

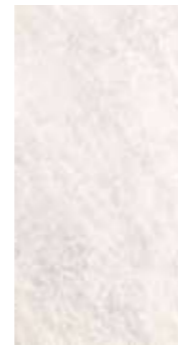

J87317
20,3x40,6 (8"x16")

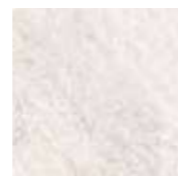

J87388
20,3x20,3 (8"x8")

beige

IN R10
C



J87286
60,5x60,5 (24"x24")

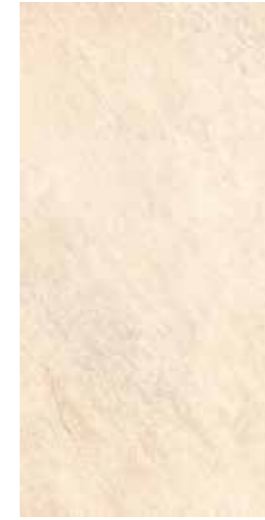

J87294
30,5x60,5 (12"x24")



J87290
60x60 rett. (24"x24") rect.

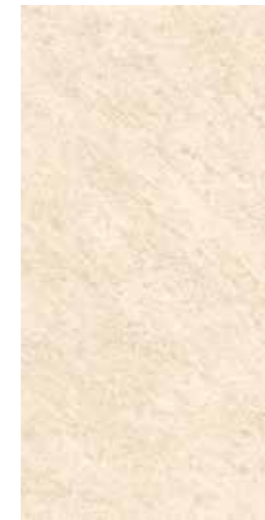

J87298
30x60 rett. (12"x24") rect.



J87318 Mosaico
30x30 (12"x 12")

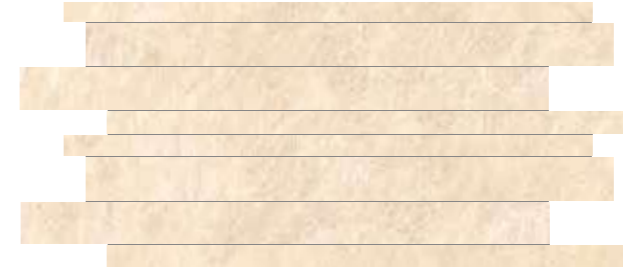

J87322 Muretto
30x60 (12"x 24")

OUT R11
C



J87615 GRIP
30,5x60,5 (12"x24")



J87314
20,3x40,6 (8"x16")

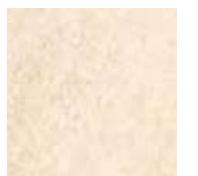

J87385
20,3x20,3 (8"x8")

grey sviluppo grafico 60x60 rett. (12"x12") rect.



15 60x60

GRAFICHE DIVERSE
DIFFERENT PATTERNS
DIFFÉRENTS MOTIFS
VERSCHIEDENE MUSTER

45 20,3x40,6

GRAFICHE DIVERSE
DIFFERENT PATTERNS
DIFFÉRENTS MOTIFS
VERSCHIEDENE MUSTER

30 30x60

GRAFICHE DIVERSE
DIFFERENT PATTERNS
DIFFÉRENTS MOTIFS
VERSCHIEDENE MUSTER

90 20,3x20,3

GRAFICHE DIVERSE
DIFFERENT PATTERNS
DIFFÉRENTS MOTIFS
VERSCHIEDENE MUSTER

	60,5x60,5 (24"x24")	60x60 rett. (24"x24") rect.	30,5x60,5 (12"x24")	GRIP 30,5x60,5 (12"x24")	30x60 rett. (12"x24") rect.	20,3x40,6 (8"x16")	20,3x20,3 (8"x8")
GREY	J87287	J87291	J87295	J87616	J87299	J87315	J87386
LIGHT GREY	J87288	J87292	J87296	J87617	J87300	J87316	J87387
WHITE	J87289	J87293	J87297	J87618	J87301	J87317	J87388
BEIGE	J87286	J87290	J87294	J87615	J87298	J87314	J87385
SPESSORE THICKNESS	9,5 mm	9,5 mm	9,5 mm	9,5 mm	9,5 mm	9 mm	9 mm
KG/M ²	21,32	21	19,78	19,78	19,2	19,00	18,10
PZ/BOX	3	3	6	6	6	13	30
M ² /BOX	1,10	1,08	1,11	1,11	1,08	1,07	1,24
BOX/PALLET	40	40	48	48	48	72	60
M ² /PALLET	44	43,20	53,28	53,28	51,84	77,04	74,40
KG/PALLET	924	907,2	1012,3	1012,3	995,3	1463,8	1347
€ <1 PALLET	48,00/m ²	54,00/m ²	42,00/m ²	43,80/m ²	46,10/m ²	39,60/m ²	39,60/m ²
€ >1 PALLET	40,00/m ²	45,00/m ²	35,00/m ²	36,50/m ²	38,40/m ²	33,00/m ²	33,00/m ²

	Mosaico 30x30 (12"x12")	Muretto 30x60 (12"x24")	Battiscopa 7,5x60 (3"x24")	Battiscopa 8x45 (3 1/4"x18")	Elem. a L monolitico 10x40,6x5 (4"x16"x2")	Elem. a L monolitico 15x30,5x4 (6"x12"x1 1/2")	Gradino+Toro 30,5x30,5 (12"x12")	Angolo+Toro 30,5x30,5 (12"x12")
GREY	J87319	J87323	J87407	J89188	J87327	J89380	J87411	J87415
LIGHT GREY	J87320	J87324	J87408	J89189	J87328	J89381	J87412	J87416
WHITE	J87321	J87325	J87409	J89190	J87329	J89382	J87413	J87417
BEIGE	J87318	J87322	J87406	J89187	J87326	J89379	J87410	J87414
PZ/BOX	6	4	12	30	8	8	6	2
€ /UM	122,20/m ²	109,00/m ²	9,30 pz/pce	5,40 ml	23,00 pz/pce	16,4 pz/pce	31,30 pz/pce	60,20 pz/pce

Contributo spese imballo € 10,00/pal (netto). - Packing charges € 10,00/pal (net)

< 0,2%
 A • HA • LA
 OK
 > 42 N/mm²
 8
 5
 Classe V
 R10_C
 R11_C
 V3

Dcof: Wet 0,60 Dcof: Wet 0,72
 Pendulum: Pendulum:
 Dry/Wet > 36 Dry 59 • Wet 37



floor
Sandstones - Citron Stone 60x100 H20

SANDSTONES

[Back to Index](#)



CITRON STONE



FOSSIL STONE



**PIETRE
&
MARM**

GRES PORCELLANATO SMALTATO
GLAZED PORCELAIN STONEWARE
GRES CERAME EMAILLE
GLASIERTESFEINSTEINZEUG



60x100 rett.
24"x39 1/4" rect.



floor
Sandstones - Fossil Stone 60x100 H20

citron stone **h20**



J89445
60x100 rett. (24"x39 1/4") rect.

fossil stone **h20**



J89378
60x100 rett. (24"x39 1/4") rect.



citron stone sviluppo grafico 60x100 rett. (24"x39 1/4") rect.



17 60x100

GRAFICHE DIVERSE
DIFFERENT PATTERNS
DIFFÉRENTS MOTIFS
VERSCHIEDENE MUSTER

fossil stone sviluppo grafico 60x100 rett. (24"x39 1/4") rect.



	60x100 (24"x39 1/4")
CITRON STONE	J89445
FOSSIL STONE	J89378
SPESSORE THICKNESS	20 mm
KG/M²	40,00
PZ/BOX	1
M²/BOX	0,60
BOX/PALLET	48
M²/PALLET	28,80
KG/PALLET	1152
€ < 1 PALLET	107,00/m²
€ > 1 PALLET	93,00/m²

Contributo spese imballo € 10,00/pal (netto)
Packing charges € 10,00/pal (net)





floor
 Terre d'Otranto - Blend
 60,5x60,5 - 30,5x60,5 - 40,6x40,6

[Back to Index](#)

TERRE D'OTRANTO



GRES PORCELLANATO A IMPASTO COLORATO
 FULL BODY PORCELAIN STONEWARE
 GRES CERAME A PATE COLOREE
 DURCHGEFÄRBTES FEINSTEINZEUG

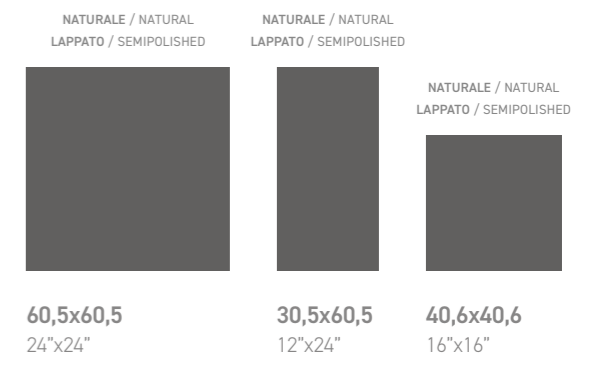
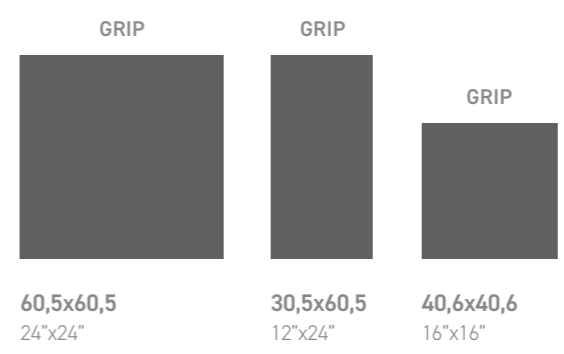
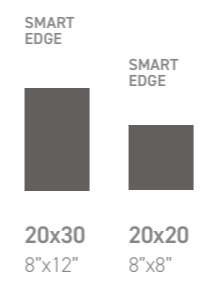

TERRE D'OTRANTO

IN

R9
A

OUT

R11
C
GRIP

cream



J88823
60,5x60,5 (24"x24")

J88983 Lappato/Semipolished
60,5x60,5 (24"x24")



J88903
30,5x60,5 (12"x24")

J88986 Lappato/Semipolished
30,5x60,5 (12"x24")

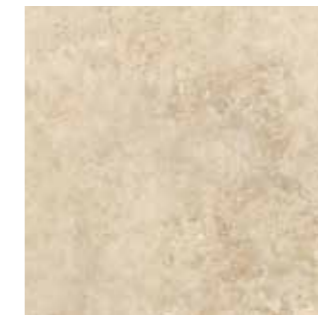

J88839
40,6x40,6 (16"x16")

J88989 Lappato/Semipolished
40,6x40,6 (16"x16")

h20



J88848
20x30 (8"x12") SMART EDGE

h20



J88847
20x20 (8"x8") SMART EDGE

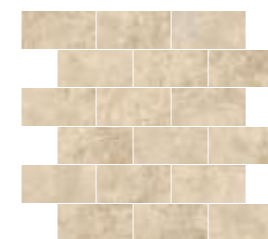

J89150 Mosaico Mattoncino
30x30 (12"x12")



J89152 Mosaico Opus Incertum
30x30 (12"x12")

floor
Terre d'Otranto - Cream 20x30 - 20x20

ivory



J88825
60,5x60,5 (24"x24")

J88984 Lappato/Semipolished
60,5x60,5 (24"x24")



J88904
30,5x60,5 (12"x24")

J88987 Lappato/Semipolished
30,5x60,5 (12"x24")



J88841
40,6x40,6 (16"x16")

J88990 Lappato/Semipolished
40,6x40,6 (16"x16")

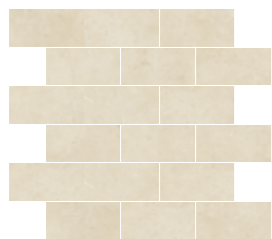

J89151 Mosaico Mattoncino
30x30 (12"x12")



J89152 Mosaico Opus Incertum
30x30 (12"x12")

blend



J88906
60,5x60,5 (24"x24")

J88982 Lappato/Semipolished
60,5x60,5 (24"x24")



J88905
30,5x60,5 (12"x24")

J88985 Lappato/Semipolished
30,5x60,5 (12"x24")



J88907
40,6x40,6 (16"x16")

J88988 Lappato/Semipolished
40,6x40,6 (16"x16")



J89149 Mosaico Mattoncino
30x30 (12"x12")



J89152 Mosaico Opus Incertum
30x30 (12"x12")



J89203 GRIP
60,5x60,5 (24"x24")



J89205 GRIP
30,5x60,5 (12"x24")



J89204 GRIP
40,6x40,6 (16"x16")

cream sviluppo grafico 60,5x60,5 (24"x24")

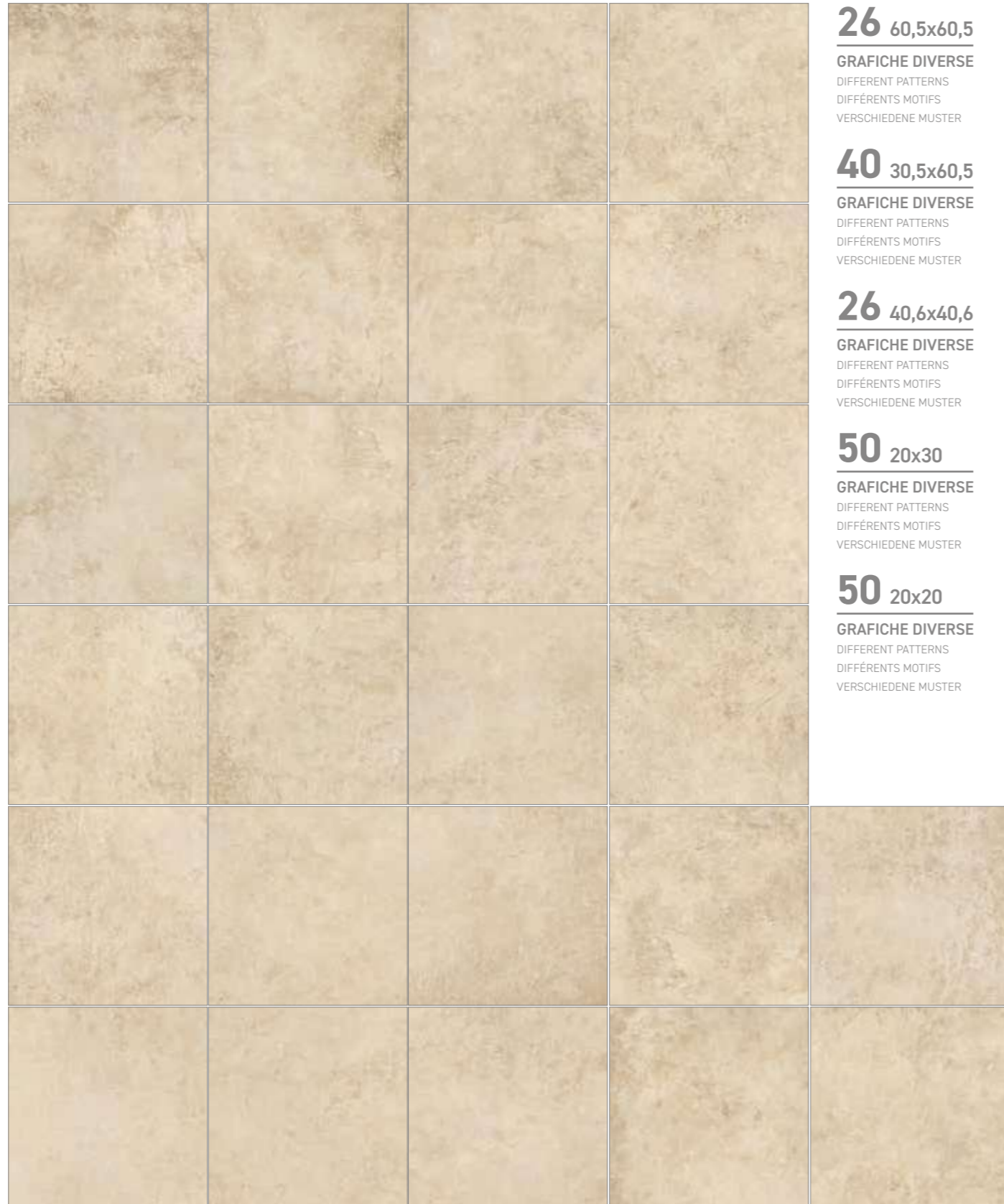

26 60,5x60,5

GRAFICHE DIVERSE
DIFFERENT PATTERNS
DIFFÉRENTS MOTIFS
VERSCHIEDENE MUSTER

40 30,5x60,5

GRAFICHE DIVERSE
DIFFERENT PATTERNS
DIFFÉRENTS MOTIFS
VERSCHIEDENE MUSTER

26 40,6x40,6

GRAFICHE DIVERSE
DIFFERENT PATTERNS
DIFFÉRENTS MOTIFS
VERSCHIEDENE MUSTER

50 20x30

GRAFICHE DIVERSE
DIFFERENT PATTERNS
DIFFÉRENTS MOTIFS
VERSCHIEDENE MUSTER

50 20x20

GRAFICHE DIVERSE
DIFFERENT PATTERNS
DIFFÉRENTS MOTIFS
VERSCHIEDENE MUSTER

									
	60,5x60,5 (24"x24")	30,5x60,5 (12"x24")	40,6x40,6 (16"x16")	Lappato/Semipol. 60,5x60,5 (24"x24")	Lappato/Semipol. 30,5x60,5 (12"x24")	Lappato/Semipol. 40,6x40,6 (16"x16")	GRIP 60,5x60,5 (24"x24")	GRIP 30,5x60,5 (12"x24")	GRIP 40,6x40,6 (16"x16")
CREAM	J88823	J88903	J88839	J88983	J88986	J88989	-	-	-
IVORY	J88825	J88904	J88841	J88984	J88987	J88990	-	-	-
BLEND	J88906	J88905	J88907	J88982	J88985	J88988	J89203	J89205	J89204
SPESSORE THICKNESS	9,5 mm	9,5 mm	9,5 mm	9,5 mm	9,5 mm	9,5 mm	9,5 mm	9,5 mm	9,5 mm
KG/M²	20,64	19,54	17,37	20,64	19,54	17,37	20,82	18,56	17,37
PZ/BOX	3	6	6	3	6	6	3	6	6
M²/BOX	1,10	1,11	1,00	1,10	1,11	1,00	1,10	1,11	1,00
BOX/PALLET	40	48	72	40	48	72	40	48	72
M²/PALLET	44,00	53,28	71,28	44,00	53,28	71,28	44,00	53,28	71,28
KG/PALLET	908,4	1041,12	1238,4	908,4	1041,12	1238,4	916,4	989,28	1238,4
€ <1 PALLET	48,00/m²	48,00/m²	48,00/m²	60,00/m²	60,00/m²	60,00/m²	51,60/m²	51,60/m²	51,60/m²
€ >1 PALLET	40,00/m²	40,00/m²	40,00/m²	50,00/m²	50,00/m²	50,00/m²	43,00/m²	43,00/m²	43,00/m²

						
	Mosaico Mattoncino 30x30 (12"x12")	Mosaico Opus Incertum 30x30 (12"x12")	h20 20x30 Smart Edge (8"x12") Smart Edge	h20 20x20 Smart Edge (8"x8") Smart Edge	Griglia 20x30 (8"x12")	Battiscopa 8x45 (3 1/2"x18")
CREAM	J89150	J89152	J88848	J88847	J89160	J89224
IVORY	J89151	J89152	-	-	-	J89225
BLEND	J89149	J89152	-	-	-	J89223
SPESSORE THICKNESS	9,5 mm	9,5 mm	20 mm	20 mm	20 mm	-
KG/M²	-	-	40,37	40,77	-	-
PZ/BOX	6	6	9	13	6	30
M²/BOX	-	-	0,54	0,52	-	-
BOX/PALLET	-	-	64	68	-	42
M²/PALLET	-	-	34,56	35,36	-	-
KG/PALLET	-	-	1395,2	1441,6	-	-
€ <1 PALLET	195,00/m²	225,00/m²	114,50/m²	114,50/m²	65,00 pz/pce	5,40 ml
€ >1 PALLET	195,00/m²	225,00/m²	99,50/m²	99,50/m²	65,00 pz/pce	5,40 ml

Contributo spese imballo € 10,00/pal (netto). - Packing charges € 10,00/pal (net)

										
0,15%	A • HA • LA	OK	>45 N/mm²	6	5	Classe V	Dcof: > 0,42 Pendulum: > 36	Dcof: Wet > 0,42 Pendulum: Dry 25 • Wet 35	V2	V3



floor
 Valeria - Beige Lineare 60x60
 Valeria - Beige Arco Bruno 60x60

[Back to Index](#)

VALERIA

Designed and registered by Rondine

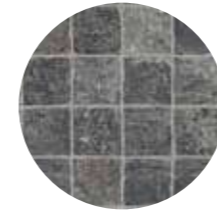

GRAFITE

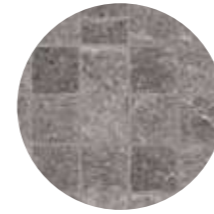

GRIGIO



CENERE



MANDORLA



BEIGE



PIETRE & MARMI

GRES PORCELLANATO A IMPASTO COLORATO
 FULL BODY PORCELAIN STONWARE
 GRES CERAME A PATE COLOREE
 DURCHGEFÄRBTES FEINSTEINZEUG

Coordinato con:
 Coordinated with:
ASIAGO
 SEZ. 3D
 PG. 93

LE CAVE
 SEZ. PIETRE E MARMI
 PG. 381



20 mm

h20

SMART
EDGE



60x60 rett.
 24"x24" rect.



60,5x60,5
 24"x24"

9,5 mm



60,5x60,5
 24"x24"



grafite lineare



J88408 60,5x60,5 (24"x24")

grafite arco

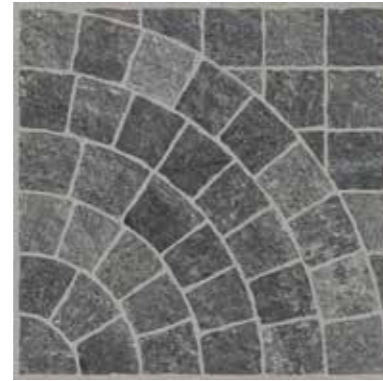

J88406 60,5x60,5 (24"x24")

grafite arco bianco



J88407 60,5x60,5 (24"x24")

mandorla lineare



J88414 60,5x60,5 (24"x24")

mandorla arco



J88412 60,5x60,5 (24"x24")

mandorla arco bianco



J88413 60,5x60,5 (24"x24")

grigio lineare



J88411 60,5x60,5 (24"x24")

grigio arco



J88409 60,5x60,5 (24"x24")

grigio arco bianco

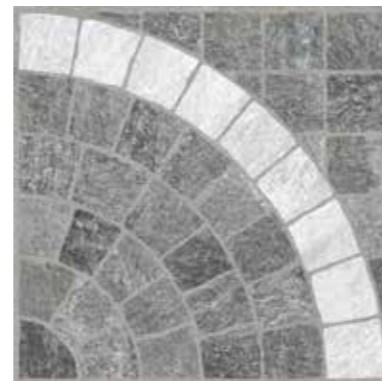

J88410 60,5x60,5 (24"x24")

beige lineare



J88402 60,5x60,5 (24"x24")

beige arco



J88400 60,5x60,5 (24"x24")

beige arco bianco



J88401 60,5x60,5 (24"x24")

cenere lineare



J88405 60,5x60,5 (24"x24")

cenere arco



J88403 60,5x60,5 (24"x24")

cenere arco bianco



J88404 60,5x60,5 (24"x24")



grafite lineare



J88377 60,5x60,5 (24"x24") Smart Edge
J88392 60x60 rett. (24"x24") rect.

grafite arco

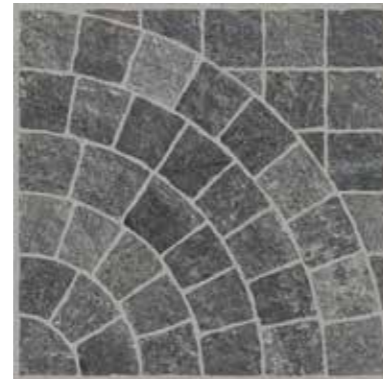

J88375 60,5x60,5 (24"x24") Smart Edge
J88390 60x60 rett. (24"x24") rect.

grafite arco bianco



J88376 60,5x60,5 (24"x24") Smart Edge
J88391 60x60 rett. (24"x24") rect.

beige lineare



J88371 60,5x60,5 (24"x24") Smart Edge
J88386 60x60 rett. (24"x24") rect.

beige arco



J88369 60,5x60,5 (24"x24") Smart Edge
J88384 60x60 rett. (24"x24") rect.

beige arco bianco



J88370 60,5x60,5 (24"x24") Smart Edge
J88385 60x60 rett. (24"x24") rect.

grigio lineare



J88380 60,5x60,5 (24"x24") Smart Edge
J88395 60x60 rett. (24"x24") rect.

grigio arco



J88378 60,5x60,5 (24"x24") Smart Edge
J88393 60x60 rett. (24"x24") rect.

grigio arco bianco

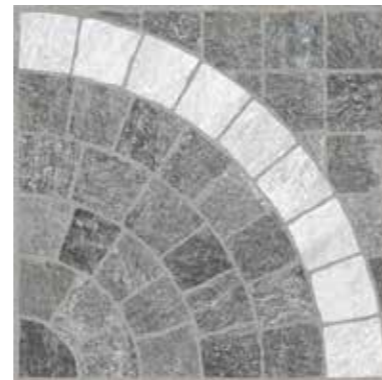

J88379 60,5x60,5 (24"x24") Smart Edge
J88394 60x60 rett. (24"x24") rect.

beige lineare sviluppo grafico 60,5x60,5 (24"x24")



720 TOZZETTI

GRAFICHE DIVERSE
DIFFERENT PATTERNS
DIFFÉRENTS MOTIFS
VERSCHIEDENE MUSTER

20 60x60

GRAFICHE DIVERSE
DIFFERENT PATTERNS
DIFFÉRENTS MOTIFS
VERSCHIEDENE MUSTER

	60,5x60,5 (24"x24")	Elemento a L incollato 60,5x60,5x10 (24"x24"x4")	60,5x60,5 Smart Edge (24"x24") Smart Edge	60x60 rett. (24"x24") rect.	Elemento a L incollato 60x60x10 rett. (24"x24"x4") rect.
GRAFITE					
ARCO	J88406	-	J88375	J88390	-
ARCO BIANCO	J88407	-	J88376	J88391	-
LINEARE	J88408	J88419	J88377	J88392	J88420
GRIGIO					
ARCO	J88409	-	J88378	J88393	-
ARCO BIANCO	J88410	-	J88379	J88394	-
LINEARE	J88411	J88421	J88380	J88395	J88422
CENERE					
ARCO	J88403	-	-	-	-
ARCO BIANCO	J88404	-	-	-	-
LINEARE	J88405	J88417	-	-	-
MANDORLA					
ARCO	J88412	-	-	-	-
ARCO BIANCO	J88413	-	-	-	-
LINEARE	J88414	J88423	-	-	-
BEIGE					
ARCO	J88400	-	J88369	J88384	-
ARCO BRUNO	J88401	-	J88370	J88385	-
LINEARE	J88402	J88415	J88371	J88386	J88416
SPESSORE THICKNESS	9,5 mm	9,5 mm	20 mm	20 mm	20 mm
KG/M²	21,23	-	43,15	43,19	-
PZ/BOX	3	1	2	2	1
M²/BOX	1,10	-	0,73	0,72	-
BOX/PALLET	40	-	32	32	-
M²/PALLET	44,00	-	23,36	23,04	-
KG/PALLET	934,4	-	1008	995,2	-
€ < 1 PALLET	54,00/m²	50,00 pz/pce	80,00/m²	84,00/m²	88,00 pz/pce
€ > 1 PALLET	45,00/m²	50,00 pz/pce	69,50/m²	73,00/m²	88,00 pz/pce

Contributo spese imballo € 10,00/pal (netto). - Packing charges € 10,00/pal (net)



0,10%



A • HA • LA



OK



sp.9,5 mm > 45 N/mm²
sp.20 mm > 55 N/mm²



8



5

h20



>150 N/mm²



Dcof: Wet 0,72
Pendulum:
Dry 55 • Wet 47



V3

VALSERTAL STONE

[Back to Index](#)

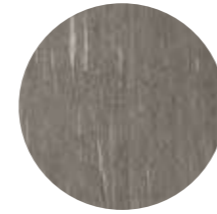

DARK GREY



GREIGE

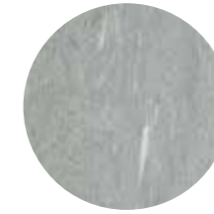

GREY



PIETRE & MARMI

GRES PORCELLANATO A IMPASTO COLORATO
FULL BODY PORCELAIN STONEWARE
GRES CERAME A PATE COLOREE
DURCHGEFÄRBTES FEINSTEINZEUG

OUT 20 mm

h²⁰



60x100 rett.
24"x39 1/4" rect.

IN 9,5 mm



60x120 rett.
24"x48" rect.



30x60 rett.
12"x24" rect.

IN R10
A

OUT R11
C

dark grey



J89171
60x120 rett. (24"x48") rect.



J89175
30x60 rett. (12"x24") rect.

h20



J89184
60x100 rett. (24"x39 1/4") rect.
Disponibili pezzi speciali H20 a pag. 683



J89194 Muretto
30x60 (12"x24")

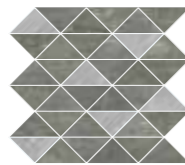

J89363 Triangle
(Mix Dark Grey/Grey)
31x31 (12 1/8"x12 1/8")

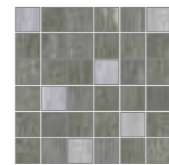

J89366 Mosaico
(Mix Dark Grey/Grey)
30x30 (12"x12")

IN R10
A

OUT R11
C

greige



J89178
60x120 rett. (24"x48") rect.



J89180
30x60 rett. (12"x24") rect.

h20



J89186
60x100 rett. (24"x39 1/4") rect.
Disponibili pezzi speciali H20 a pag. 683



J89196 Muretto
30x60 (12"x24")

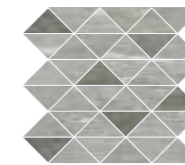

J89364 Triangle
(Mix Greige/Dark Grey)
31x31 (12 1/8"x12 1/8")

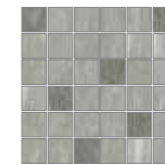

J89367 Mosaico
(Mix Greige/Dark Grey)
30x30 (12"x12")

VALSERTAL STONE

IN R10
A

OUT R11
C



grey



J89172
60x120 rett. (24"x48") rect.



J89176
30x60 rett. (12"x24") rect.

h20



J89185
60x100 rett. (24"x39 1/4") rect.

Disponibili pezzi speciali H20 a pag. 683



J89195 Muretto
30x60 (12"x24")

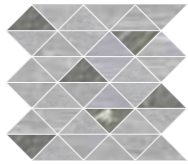

J89365 Triangle
(Mix Grey/Dark Grey)
31x31 (12 1/8"x12 1/8")

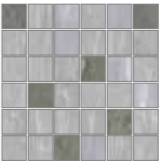

J89368 Mosaico
(Mix Grey/Dark Grey)
30x30 (12"x12")

grey sviluppo grafico 60x120 (24"x48")

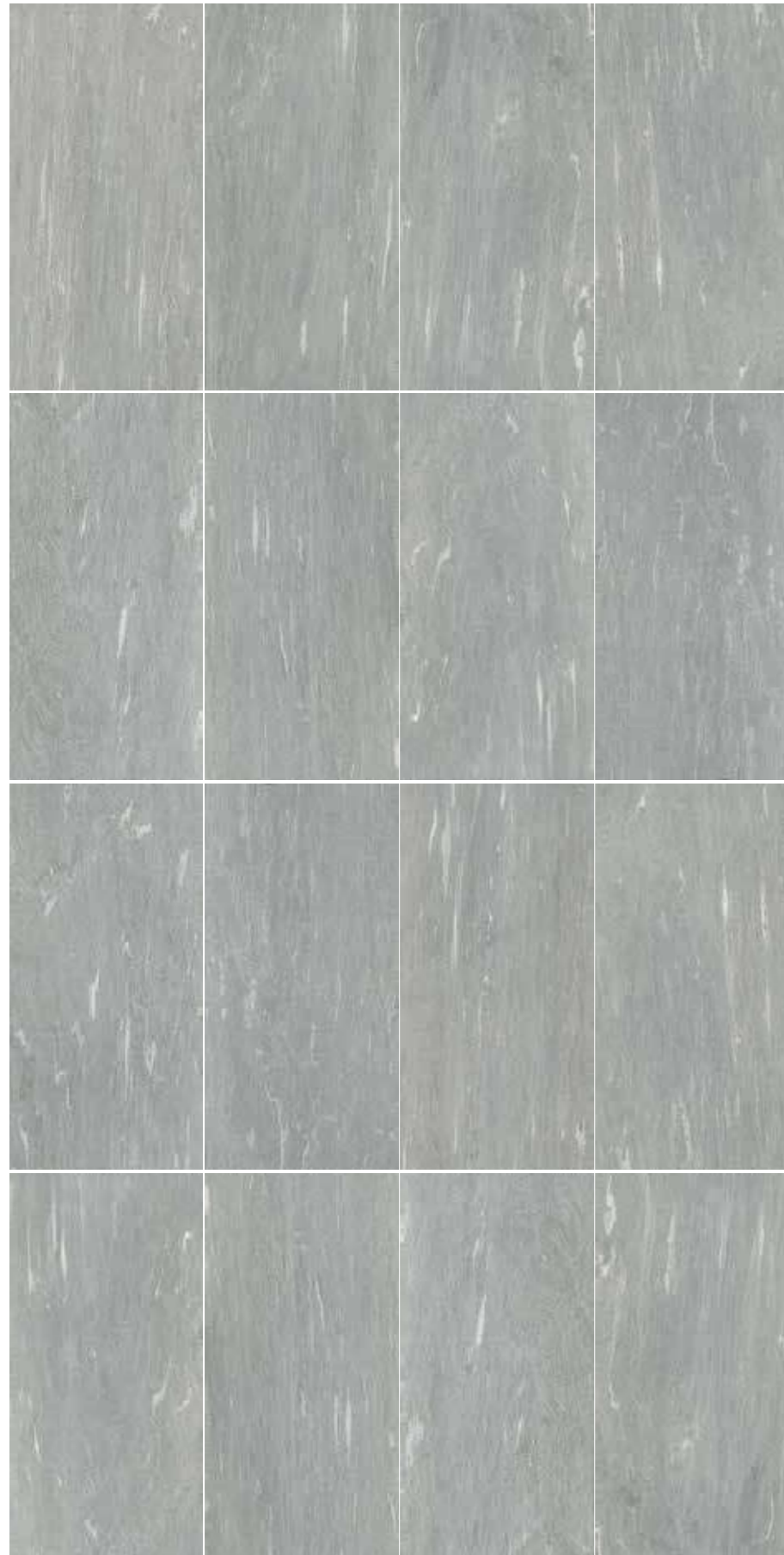

18 60x120











GRAFICHE DIVERSE
DIFFERENT PATTERNS
DIFFÉRENTS MOTIFS
VERSCHIEDENE MUSTER

18 60x100

GRAFICHE DIVERSE
DIFFERENT PATTERNS
DIFFÉRENTS MOTIFS
VERSCHIEDENE MUSTER

72 30x60

GRAFICHE DIVERSE
DIFFERENT PATTERNS
DIFFÉRENTS MOTIFS
VERSCHIEDENE MUSTER

			 h20				
	60x120 rett. (24"x48") rect.	30x60 rett. (12"x24") rect.	h20 60x100 rett. (24"x39 1/2") rect.	Mosaico 30x30 (12"x12")	Triangle 31x31 (12 1/8"x12 1/8")	Muretto 30x60 (12"x24")	Battiscopa 7,5x60 (3"x24")
 DARK GREY	J89171	J89175	J89184	J89366	J89363	J89194	J89369
 GREIGE	J89178	J89180	J89186	J89367	J89364	J89196	J89370
 GREY	J89172	J89176	J89185	J89368	J89365	J89195	J89371
SPESSORE THICKNESS	9,5 mm	9,5 mm	20 mm	9,5 mm	9,5 mm	9,5 mm	9,5 mm
KG/M²	21,40	19,93	40,00	17,60	16,38	20,00	-
PZ/BOX	2	6	1	6	6	4	12
M²/BOX	1,44	1,08	0,60	0,54	0,58	0,72	-
BOX/PALLET	32	48	48	60	60	60	-
M²/PALLET	46,08	51,84	28,80	32,40	34,80	43,20	-
KG/PALLET	986,24	1032,96	1152	570	570	864	-
€ <1 PALLET	65,00/m²	46,10/m²	107,00/m²	122,80/m²	240,00/m²	122,20/m²	9,30 pz/pce
€ >1 PALLET	56,50/m²	38,40/m²	93,00/m²	122,80/m²	240,00/m²	122,20/m²	9,30 pz/pce

Contributo spese imballo € 10,00/pal (netto). - Packing charges € 10,00/pal (net)

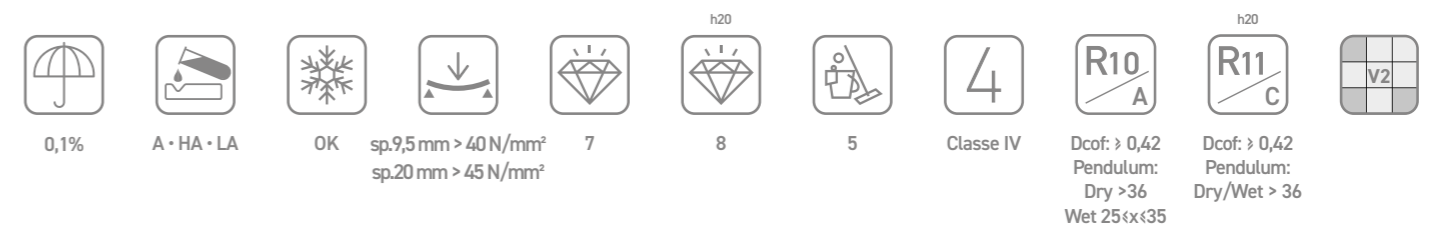

MATERIE

Bristol Effetto Cotto - Cotto	467	Manhattan Effetto Cemento - Cement	563
Concrete Effetto Cemento - Cement	473	Murales Effetto Cemento - Cement	573
Docks Effetto Cemento - Cement	489	Oxyd Effetto Metallo - Metal	585
Icon Effetto Cemento - Cement	499	Rust Effetto Metallo - Metal	595
ICC Effetto Cemento - Cement	515	Swing Effetto Cemento - Cement	605
Loft Effetto Cemento - Cement	525	Tuscany Effetto Cotto - Cotto	615
London Effetto Cotto - Cotto	557	Volcano Effetto Cemento - Cement	623

“ Essenzialità di stile, linearità degli elementi per valorizzare l'architettura più attuale. Cotti, Cementi e Metalli trovano nuova vita nelle collezioni di Rondine, per vestire la dimensione abitativa di una moderna eleganza che si addice alle tendenze contemporanee dell'interior design.

”

Essential style, linear elements to make the most of today's architecture. New life comes to cotto tiles, cements and metals in the Rondine collections, dressing any home with the modern elegance demanded by the contemporary trends of interior design.

Essentialité de style, linéarité des éléments pour valoriser l'architecture la plus actuelle. Les Cotto, ciments et métaux trouvent une vie nouvelle au sein des collections de Rondine afin de revêtir la dimension d'habitation d'une élégance moderne qui cadre avec les tendances contemporaines du design d'intérieur.

Hochmoderne Architektur durch essentiellen Stil und Linearität der Elemente. Cotto, Zement und Metall stellen in den Kollektionen Rondine eine neue Art der Wohngestaltung vor, die mit moderner Eleganz die kontemporäre Tendenz des "Interior Design" zum Ausdruck bringt.



floor
Bristol - Rust 17x34

[Back to Index](#)

BRISTOL



DARK



RUST



CREAM



RED



UMBER



GRES PORCELLANATO SMALTATO
GLAZED PORCELAIN STONEWARE
GRES CERAME EMAILLE
GLASIERTESFEINSTEINZEUG

Coordinato con:
Coordinated with:
BRISTOL
SEZ. BRICK GENERATION
PG. 17



34x34
13 1/2"x13 1/2"



17x34
7"x13 1/2"

dark

OUT IN R10 B



J85530
34x34 (13 1/2"x13 1/2")



J85535
17x34 (7"x13 1/2")



J85668
6x25 (2 1/3"x10")

Coordinato con:
Coordinated with:
BRISTOL
SEZ. BRICK GENERATION
PG. 17



rust

OUT IN R10 B



J85532
34x34 (13 1/2"x13 1/2")



J85537
17x34 (7"x13 1/2")



J85670
6x25 (2 1/3"x10")

Coordinato con:
Coordinated with:
BRISTOL
SEZ. BRICK GENERATION
PG. 17

cream



J85529
34x34 (13 1/2"x13 1/2")



J85534
17x34 (7"x13 1/2")



J85667
6x25 (2 1/3"x10")

Coordinato con:
Coordinated with:
BRISTOL
SEZ. BRICK GENERATION
PG. 17

red



J85531
34x34 (13 1/2"x13 1/2")



J85536
17x34 (7"x13 1/2")



Coordinato con:
Coordinated with:
BRISTOL
SEZ. BRICK GENERATION
PG. 17

J85669
6x25 (2 1/3"x10")

umber



J85533
34x34 (13 1/2"x13 1/2")



J85538
17x34 (7"x13 1/2")



Coordinato con:
Coordinated with:
BRISTOL
SEZ. BRICK GENERATION
PG. 17

J85671
6x25 (2 1/3"x10")

rust sviluppo grafico 17x34 (13 1/2"x13 1/2")



61 34x34

GRAFICHE DIVERSE
DIFFERENT PATTERNS
DIFFÉRENTS MOTIFS
VERSCHIEDENE MUSTER

31 17x34

GRAFICHE DIVERSE
DIFFERENT PATTERNS
DIFFÉRENTS MOTIFS
VERSCHIEDENE MUSTER

	34x34 (13 1/2"x13 1/2")	17x34 (7"x13 1/2")	Battiscopa 8x33,3 (3 1/4"x13")	Elemento a L. mono. 15,5x30x4 (6"x12"x1 1/2")	Elemento a L. inc. 17x34x5 (7"x13 1/2"x2")	Gradino+Toro 34x34 (13 1/2"x13 1/2")	Angolo+Toro 34x34 (13 1/2"x13 1/2")	6x25 (2 1/3"x10")
DARK	J85530	J85535	J85550	J85853	J85738	J85540	J85545	J85668
RUST	J85532	J85537	J85552	J85855	J85740	J85542	J85547	J85670
CREAM	J85529	J85534	J85549	J85852	J85737	J85539	J85544	J85667
RED	J85531	J85536	J85551	J85854	J85739	J85541	J85546	J85669
UMBER	J85533	J85538	J85553	J85856	J85741	J85543	J85548	J85671
SPESSORE THICKNESS	8,5 mm	8,5 mm	8,5 mm	8,5 mm	8,5 mm	8,5 mm	8,5 mm	9,5 mm
KG/M²	16,1	16,1	16,1	-	-	-	-	16,9
PZ/BOX	11	23	27	8	8	6	2	32
M²/BOX	1,27	1,35	9 ml	-	-	-	-	0,58 *
BOX/PALLET	48	48	66	-	-	-	-	100
M²/PALLET	60,96	64,8	594 ml	-	-	-	-	58
KG/PALLET	982	1043,3	742,50	-	-	-	-	980,2
€ <1 PALLET	39,60/m²	39,60/m²	4,80/ml	16,40 pz/pce	14,40 pz/pce	31,30 pz/pce	60,20 pz/pce	64,90/m²
€ >1 PALLET	33,00/m²	33,00/m²	4,80/ml	16,40 pz/pce	14,40 pz/pce	31,30 pz/pce	60,20 pz/pce	56,40/m²

Contributo spese imballo € 10,00/pal (netto). - Packing charges € 10,00/pal (net)

* Compresa fuga di 1 cm - 1 cm joint included

0,3%
 A • HA • LA
 OK
 48 N/mm²
 6
 5
 Dark
 4
 5
 R10/B
 V4

Classe IV
 Classe V
 Dcof: Wet 0,62
 Pendulum: Dry 55 • Wet 48



wall
Concrete - Taupe 40x80

floor
Concrete - Taupe 80x80

[Back to Index](#)

CONCRETE



DARK

LIGHT GREY

WHITE

SAND

TAUPE



GRES PORCELLANATO A IMPASTO COLORATO
FULL BODY PORCELAIN STONEWARE
GRES CERAME A PATE COLOREE
DURCHGEFÄRBTES FEINSTEINZEUG

Coordinato con:
Coordinated with:
LE LACCHE
SEZ. BRICK GENERATION
PG. 25



80x80 rett.
31 1/2"x31 1/2" rect.

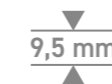

80x80 rett.
31 1/2"x31 1/2" rect.



60x120 rett.
24"x48" rect.



80x80 rett.
31 1/2"x31 1/2" rect.



40x80 rett.
16"x31 1/2" rect.



60x60 rett.
24"x24" rect.



30x60 rett.
12"x24" rect.



30,5x60,5
12"x24"



dark



J87878
60x120 rett. (24"x48") rect.



J87935
60x60 rett. (24"x24") rect.



J87947
30x60 rett. (12"x24") rect.



J87941
30,5x60,5 (12"x24")

h20



J88008
80x80 rett. (31 1/2"x31 1/2") rect.
Disponibili pezzi speciali H20 a pag. 682



J88065 GRIP
80x80 rett. (31 1/2"x31 1/2") rect.



J87915
80x80 rett. (31 1/2"x31 1/2") rect.



J88003
40x80 rett. (16"x31 1/2") rect.

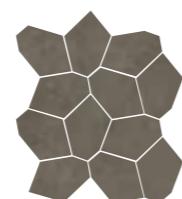

J88103 Piramide
30x30 (12"x12")



J88098 Muretto
30x60 (12"x24")



light grey



J87880
60x120 rett. (24"x48") rect.



J87937
60x60 rett. (24"x24") rect.



J87949
30x60 rett. (12"x24") rect.



J87943
30,5x60,5 (12"x24")

h20



J88009
80x80 rett. (31 1/2"x31 1/2") rect.
Disponibili pezzi speciali H20 a pag. 682



J88066 GRIP
80x80 rett. (31 1/2"x31 1/2") rect.



J87917
80x80 rett. (31 1/2"x31 1/2") rect.



J88004
40x80 rett. (16"x31 1/2") rect.

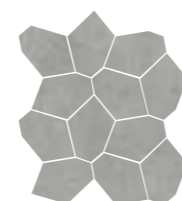

J88104 Piramide
30x30 (12"x12")

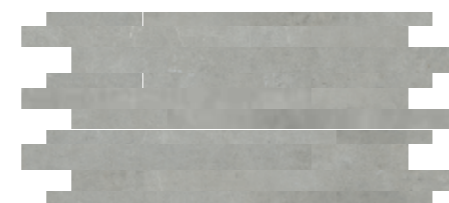

J88099 Muretto
30x60 (12"x24")

CONCRETE



white



J87883
60x120 rett. (24"x48") rect.



J87940
60x60 rett. (24"x24") rect.



J87952
30x60 rett. (12"x24") rect.



J87946
30,5x60,5 (12"x24")



J87920
80x80 rett. (31 1/2"x31 1/2") rect.



J88007
40x80 rett. (16"x31 1/2") rect.

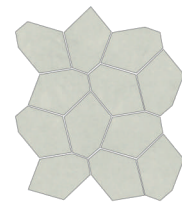

J88107 Piramide
30x30 (12"x12")

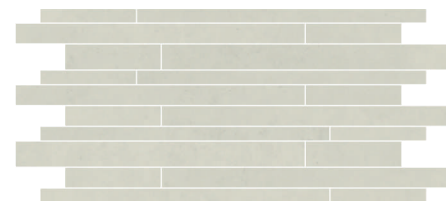

J88102 Muretto
30x60 (12"x24")





sand



J87881
60x120 rett. (24"x48") rect.



J87938
60x60 rett. (24"x24") rect.

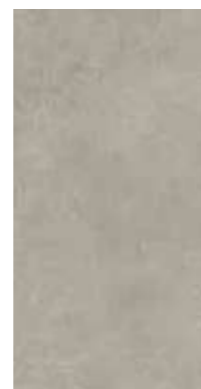

J87950
30x60 rett. (12"x24") rect.



J87944
30,5x60,5 (12"x24")

h20



J88010
80x80 rett. (31 1/2"x31 1/2") rect.
Disponibili pezzi speciali H20 a pag. 682



J88067 GRIP
80x80 rett. (31 1/2"x31 1/2") rect.



J87918
80x80 rett. (31 1/2"x31 1/2") rect.



J88005
40x80 rett. (16"x31 1/2") rect.



J88105 Piramide
30x30 (12"x12")



J88100 Muretto
30x60 (12"x24")



taupe



J87882
60x120 rett. (24"x48") rect.



J87939
60x60 rett. (24"x24") rect.

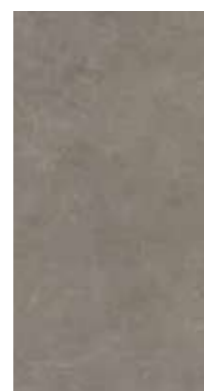

J87951
30x60 rett. (12"x24") rect.



J87945
30,5x60,5 (12"x24")

h20



J88011
80x80 rett. (31 1/2"x31 1/2") rect.
Disponibili pezzi speciali H20 a pag. 682



J88068 GRIP
80x80 rett. (31 1/2"x31 1/2") rect.



J87919
80x80 rett. (31 1/2"x31 1/2") rect.



J88006
40x80 rett. (16"x31 1/2") rect.

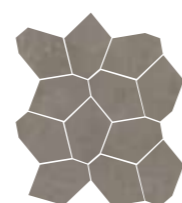

J88106 Piramide
30x30 (12"x12")



J88101 Muretto
30x60 (12"x24")



frame white



J88334
40x80 rett. (16"x31 1/2") rect.

frame light grey

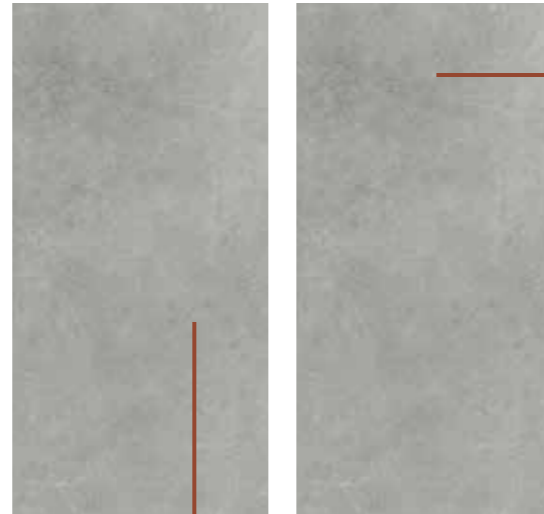

J88332
40x80 rett. (16"x31 1/2") rect.

frame sand

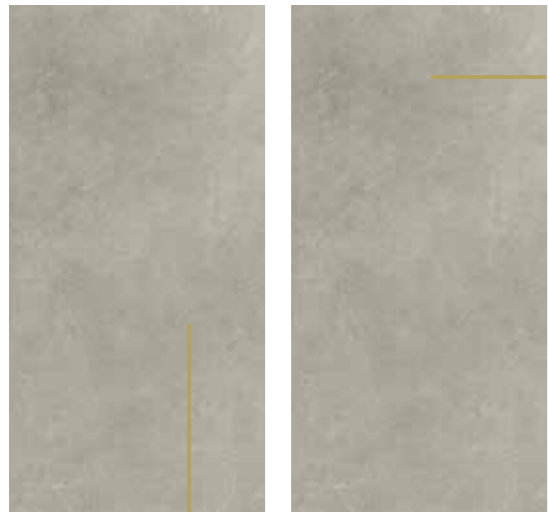

J88333
40x80 rett. (16"x31 1/2") rect.

arte white



J88331
30x60 rett. (12"x24") rect.

arte light grey



J88329
30x60 rett. (12"x24") rect.

arte sand



J88330
30x60 rett. (12"x24") rect.

taupe sviluppo grafico 60x120 (24"x48")



17 60x120

GRAFICHE DIVERSE
DIFFERENT PATTERNS
DIFFÉRENTS MOTIFS
VERSCHIEDENE MUSTER

34 60x60

GRAFICHE DIVERSE
DIFFERENT PATTERNS
DIFFÉRENTS MOTIFS
VERSCHIEDENE MUSTER

68 30x60

GRAFICHE DIVERSE
DIFFERENT PATTERNS
DIFFÉRENTS MOTIFS
VERSCHIEDENE MUSTER

14 80x80

GRAFICHE DIVERSE
DIFFERENT PATTERNS
DIFFÉRENTS MOTIFS
VERSCHIEDENE MUSTER

28 40x80

GRAFICHE DIVERSE
DIFFERENT PATTERNS
DIFFÉRENTS MOTIFS
VERSCHIEDENE MUSTER

	60x120 rett. (24"x48") rect.	60x60 rett. (24"x24") rect.	30x60 rett. (12"x24") rect.	30,5x60,5 (12"x24")	80x80 rett. (31 1/2"x31 1/2") rect.	h20 80x80 rett. (31 1/2"x31 1/2") rect.	GRIP 80x80 rett. (31 1/2"x31 1/2") rect.	40x80 rett. (16"x31 1/4") rect.
DARK	J87878	J87935	J87947	J87941	J87915	J88008	J88065	J88003
LIGHT GREY	J87880	J87937	J87949	J87943	J87917	J88009	J88066	J88004
WHITE	J87883	J87940	J87952	J87946	J87920	-	-	J88007
SAND	J87881	J87938	J87950	J87944	J87918	J88010	J88067	J88005
TAUPE	J87882	J87939	J87951	J87945	J87919	J88011	J88068	J88006
SPESSORE THICKNESS	9,5 mm	9,5 mm	9,5 mm	9,5 mm	9,5 mm	20 mm	9,5 mm	9,5 mm
KG/M²	22,02	21,57	19,34	19,21	21,21	47,65	21,1	20,87
PZ/BOX	2	3	6	6	2	1	2	3
M²/BOX	1,44	1,08	1,08	1,11	1,28	0,64	1,28	0,96
BOX/PALLET	32	40	48	48	40	40	40	33
M²/PALLET	46,08	43,20	51,84	53,28	51,20	25,60	51,20	31,68
KG/PALLET	1015,04	932	1002,72	1023,84	1086	1219,84	1080,4	661,32
€ < 1 PALLET	65,00/m²	54,00/m²	46,10/m²	42,00/m²	65,00/m²	107,00/m²	66,70/m²	60,00/m²
€ > 1 PALLET	56,50/m²	45,00/m²	38,40/m²	35,00/m²	56,50/m²	93,00/m²	58,00/m²	50,00/m²

	Muretto 30x60 (12"x24")	Piramide 30x30 (12"x12")	Frame 40x80 rett. (16"x31 1/4") rect.	Arte 30x60 rett. (12"x24") rect.	Battiscopa 7,5x60 (3"x24")	Gradino+Toro 33x120x4 (13"x48"x1 1/2")	Angolo+Toro Dx 33x120x4 (13"x48"x1 1/2")	Angolo+Toro Sx 33x120x4 (13"x48"x1 1/2")	Gradino 40x80 rett. (16"x31 1/4") rect.
DARK	J88098	J88103	-	-	J88253	J88746	J88751	J88756	J88347
LIGHT GREY	J88099	J88104	J88332	J88329	J88254	J88747	J88752	J88757	J88348
WHITE	J88102	J88107	J88334	J88331	J88257	J88750	J88755	J88760	-
SAND	J88100	J88105	J88333	J88330	J88255	J88748	J88753	J88758	J88349
TAUPE	J88101	J88106	-	-	J88256	J88749	J88754	J88759	J88350
PZ/BOX	4	6	2	2	12	2	1	1	1
€/UM	122,20/m²	240,00/m²	46,50 pz/pce	45,00 pz/pce	9,30 pz/pce	179,00 pz/pce	239,00 pz/pce	239,00 pz/pce	109,00 pz/pce

Contributo spese imballo € 10,00/pal (netto). - Packing charges € 10,00/pal (net)

0,1% A • HA • LA OK > 45 N/mm² 7 5 Classe IV Classe V R10_B R11_C R11_C V2

White, Light Grey GRIP h20
 Dcof: Wet 0,63 Dcof: Wet 0,70 Dcof: Wet 0,64
 Pendulum: Dry 48 • Wet 35 Pendulum: Dry 58 • Wet 44 Pendulum: Dry 53 • Wet 44

DOCKS

[Back to Index](#)



LIGHT GREY



WHITE



BEIGE



TAUPE



GRES PORCELLANATO SMALTATO
GLAZED PORCELAIN STONWARE
GRES CERAME EMAILLE
GLASIERTESFEINSTEINZEUG

8,5 mm



60x120 rett.
24"x48" rect.



40x80 rett.
16"x31 1/2" rect.



wall
Docks - White 60x120



wall
Docks - White 60x120

floor
Timeless - Greige 24x150



light grey



J89328
60x120 rett. (24"x48") rect.



J90008
40x80 rett. (16"x31 1/2") rect.

white



J89330
60x120 rett. (24"x48") rect.



J90010
40x80 rett. (16"x31 1/2") rect.





beige



J89325
60x120 rett. (24"x48") rect.



J90007
40x80 rett. (16"x31 1/2") rect.

taupe



J89329
60x120 rett. (24"x48") rect.

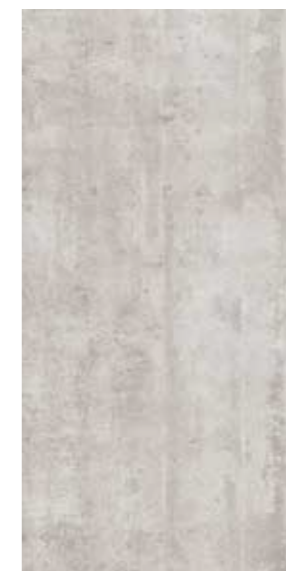

J90009
40x80 rett. (16"x31 1/2") rect.



taupe sviluppo grafico 60x120 rett. (24"x48") rect.



15 60x120

GRAFICHE DIVERSE
DIFFERENT PATTERNS
DIFFÉRENTS MOTIFS
VERSCHIEDENE MUSTER

60 30x60

GRAFICHE DIVERSE
DIFFERENT PATTERNS
DIFFÉRENTS MOTIFS
VERSCHIEDENE MUSTER

	60x120 rett. (24"x48") rect.	40x80 rett. (16"x31 1/2") rect.
LIGHT GREY	J89328	J90008
WHITE	J89330	J90010
BEIGE	J89325	J90007
TAUPE	J89329	J90009
SPESSORE THICKNESS	8,5 mm	8,5 mm
KG/M²	19,32	18,2
PZ/BOX	2	3
M²/BOX	1,44	0,96
BOX/PALLET	32	36
M²/PALLET	46,08	34,56
KG/PALLET	890,56	629
€ < 1 PALLET	65,00 / m²	60,00/m²
€ > 1 PALLET	56,50 / m²	50,00/m²

	Battiscopa 7,5x60 (3"x24")	Gradino + Toro 33x120x4 (13"x48"x1 1/2")	Gradino + Toro Dx 33x120x4 (13"x48"x1 1/2")	Gradino + Toro Sx 33x120x4 (13"x48"x1 1/2")
LIGHT GREY	J89624	J89896	J89900	J89904
WHITE	J89626	J89898	J89902	J89906
BEIGE	J89623	J89895	J89899	J89903
TAUPE	J89625	J89897	J89901	J89905
PZ/BOX	12	2	1	1
€ /UM	9,30 pz / pce	179,00 pz / pce	239,00 pz / pce	239,00 pz / pce

Contributo spese imballo € 10,00/pal (netto). - Packing charges € 10,00/pal (net)

0,1%
 A • HA • LA
 OK
 > 45 N/mm²
 7
 5
 Classe IV
 Classe V
 R10 B
 V1

Dcof: > 0,42
 Pendulum:
 Dry > 36; Wet 25 < x < 35

[Back to Index](#)



GRES PORCELLANATO A IMPASTO COLORATO
 FULL BODY PORCELAIN STONEWARE
 GRES CERAME A PATE COLOREE
 DURCHGEFÄRBTES FEINSTEINZEUG

9,5 mm



45x90 rett. 17 3/4"x35 3/4" rect.	22,5x90 rett. 8 3/4"x35 3/4" rect.	60x60 rett. 24"x24" rect.	60,5x60,5 24"x24"	30x60 rett. 12"x24" rect.	30,5x60,5 12"x24"
---	--	-------------------------------------	-----------------------------	-------------------------------------	-----------------------------



floor
 Icon - Balck 45x90



black



J85153
60,5x60,5 (24"x24")



J85165
30,5x60,5 (12"x24")



J85159
60x60 rett. (24"x24") rect.



J85171
30x60 rett. (12"x24") rect.



J85729
45x90 rett. (17 3/4"x35 3/4") rect.



J85730
22,5x90 rett. (8 3/4"x35 3/4") rect.



J85177 Muretto
30x60 (12"x24")



J85299 Mosaico
30x30 (12"x12")





gray



J85154
60,5x60,5 (24"x24")



J85166
30,5x60,5 (12"x24")



J85160
60x60 rett. (24"x24") rect.



J85172
30x60 rett. (12"x24") rect.



J85527
45x90 rett. (17 3/4"x35 3/4") rect.



J85599
22,5x90 rett. (8 3/4"x35 3/4") rect.



J85178 Muretto
30x60 (12"x24")

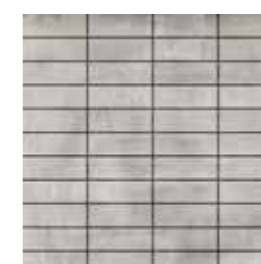

J85300 Mosaico
30x30 (12"x12")



light



J85155
60,5x60,5 (24"x24")



J85167
30,5x60,5 (12"x24")



J85161
60x60 rett. (24"x24") rect.



J85173
30x60 rett. (12"x24") rect.



J85179 Muretto
30x60 (12"x24")



J85301 Mosaico
30x30 (12"x12")



sand



J85157
60,5x60,5 (24"x24")



J85169
30,5x60,5 (12"x24")



J85163
60x60 rett. (24"x24") rect.



J85175
30x60 rett. (12"x24") rect.

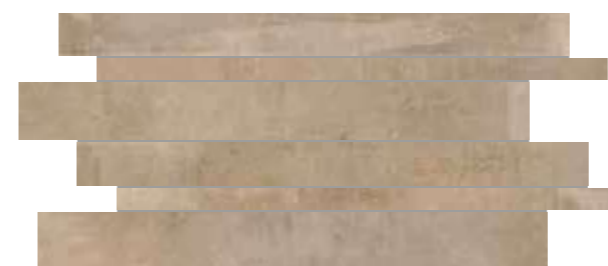

J85181 Muretto
30x60 (12"x24")



J85303 Mosaico
30x30 (12"x12")



almond



J85152
60,5x60,5 (24"x24")



J85164
30,5x60,5 (12"x24")



J85158
60x60 rett. (24"x24") rett.



J85170
30x60 rett. (12"x24") rett.



J85526
45x90 rett. (17 3/4"x35 3/4") rett.



J85598
22,5x90 rett. (8 3/4"x35 3/4") rett.



J85176 Muretto
30x60 (12"x24")



J85298 Mosaico
30x30 (12"x12")





olive



J85156
60,5x60,5 (24"x24")



J85168
30,5x60,5 (12"x24")



J85162
60x60 rett. (24"x24") rect.



J85174
30x60 rett. (12"x24") rect.



J85525
45x90 rett. (17 3/4"x35 3/4") rect.



J85597
22,5x90 rett. (8 3/4"x35 3/4") rect.



J85180 Muretto
30x60 (12"x24")



J85302 Mosaico
30x30 (12"x12")



J85251 almond history mix *
30x60 (12"x24")

* Prodotti da utilizzare solo per il rivestimento delle pareti - Products only to be used as wall tiles - Produits à utiliser seulement comme revêtement des murs - Produkte nur zur Verwendung fuer Wandbereich - Плитка может использоваться только для облицовки стен.



J85252 light history mix *
30x60 (12"x24")



folk almond 3 pezzi random per scatola - 3 random pieces per box



J85245
60,5x60,5 (24"x24")

J85247
60x60 rett. (24"x24") rect.

folk light 3 pezzi random per scatola - 3 random pieces per box



J85246
60,5x60,5 (24"x24")

J85248
60x60 rett. (24"x24") rect.

gray sviluppo grafico 60x60 rett. (24"x24") rett.



10 45x90

GRAFICHE DIVERSE
DIFFERENT PATTERNS
DIFFÉRENTS MOTIFS
VERSCHIEDENE MUSTER

20 22,5x90

GRAFICHE DIVERSE
DIFFERENT PATTERNS
DIFFÉRENTS MOTIFS
VERSCHIEDENE MUSTER

36 30x60

GRAFICHE DIVERSE
DIFFERENT PATTERNS
DIFFÉRENTS MOTIFS
VERSCHIEDENE MUSTER

18 60x60

GRAFICHE DIVERSE
DIFFERENT PATTERNS
DIFFÉRENTS MOTIFS
VERSCHIEDENE MUSTER

	45x90 rett. (17 3/4"x35 3/4") rett.	22,5x90 rett. (8 1/2"x35 3/4") rett.	60,5x60,5 (24"x24")	60x60 rett. (24"x24") rett.	30,5x60,5 (12"x24")	30x60 rett. (12"x24") rett.	Folk Almond 60x60 rett. (24"x24") rett.	Folk Almond 60,5x60,5 (24"x24")	Folk Light 60x60 rett. (24"x24") rett.	Folk Light 60,5x60,5 (24"x24")
BLACK	J85729	J85730	J85153	J85159	J85165	J85171	-	-	J85248	J85246
GRAY	J85527	J85599	J85154	J85160	J85166	J85172	-	-	J85248	J85246
LIGHT	-	-	J85155	J85161	J85167	J85173	-	-	J85248	J85246
ALMOND	J85526	J85598	J85152	J85158	J85164	J85170	J85247	J85245	-	-
SAND	-	-	J85157	J85163	J85169	J85175	J85247	J85245	-	-
OLIVE	J85525	J85597	J85156	J85162	J85168	J85174	J85247	J85245	-	-
SPESORE THICKNESS	9,5 mm	9,5 mm	9,5 mm	9,5 mm	9,5 mm	9,5 mm	9,5 mm	9,5 mm	9,5 mm	9,5 mm
KG/M²	21,72	21,72	21,8	23	20	20	23	21,8	23	21,8
PZ/BOX	3	6	3	3	6	6	3	3	3	3
M²/BOX	1,22	1,22	1,10	1,08	1,11	1,08	1,08	1,10	1,08	1,10
BOX/PALLET	32	32	40	40	48	48	40	40	40	40
M²/PALLET	39,04	39,04	44	43,20	53,28	51,84	43,20	44	43,20	44
KG/PALLET	848	848	960	993,6	1065,6	1036,8	993,6	960	993,6	960
€ <1 PALLET	61,00/m²	76,40/m²	51,60/m²	57,60/m²	46,10/m²	52,10/m²	67,60/m²	59,80/m²	67,60/m²	59,80/m²
€ >1 PALLET	53,00/m²	66,40/m²	43,00/m²	48,00/m²	38,40/m²	43,40/m²	58,70/m²	52,00/m²	58,70/m²	52,00/m²

	Mosaico 30x30 (12"x12")	Muretto 30x60 (12"x12")	Almond History Mix 30x60 (12"x12")	Light History Mix 30x60 (12"x12")	Battiscopa 7,5x60 (3"x24")	Gradino+Toro 30,5x30,5 (12"x12")	Angolo+Toro Sx 30,5x30,5 (12"x12")
BLACK	J85299	J85177	-	J85252	J85254	J85362	J85368
GRAY	J85300	J85178	-	J85252	J85255	J85363	J85369
LIGHT	J85301	J85179	-	J85252	J85256	J85364	J85370
ALMOND	J85298	J85176	J85251	-	J85253	J85361	J85367
SAND	J85303	J85181	J85251	-	J85258	J85366	J85372
OLIVE	J85302	J85180	J85251	-	J85257	J85365	J85371
PZ/BOX	6	4	4	4	12	6	2
€/UM	154,50/m²	122,20/m²	47,20 pz/pce	47,20 pz/pce	9,30 pz/pce	31,30 pz/pce	60,20 pz/pce

Contributo spese imballo € 10,00/pal (netto). - Packing charges € 10,00/pal (net)

0,1%
 A • HA • LA
 OK
 58,4 N/mm²
 5
 5
 Black 4 Classe IV
 5 Classe V
 R10 B Dcof: Wet 0,57 Pendulum: Dry 45 • Wet 27
 V2

INDUSTRIAL COLOR CHIC

Back to Index



JET BLACK



SMOKE



CLOUD



ROYAL BLUE

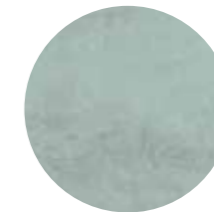

SAGE



TUMERIC



GRES PORCELLANATO A IMPASTO COLORATO
 FULL BODY PORCELAIN STONEWARE
 GRES CERAME A PATE COLOREE
 DURCHGEFÄRBTES FEINSTEINZEUG

Coordinato con:
 Coordinated with:
LE LACCHE
 SEZ. BRICK GENERATION
 PG. 25

9,5 mm



60x120 rett.
 24"x48" rect.



60x60 rett.
 24"x24" rect.



30x60 rett.
 12"x24" rect.



30,5x60,5
 12"x24"

MODULO
 MODULE



30x60 rett. (12"x24") rect.
 15x60/10x60/5x60

wall
 ICC - Royal Blue 30x60
 Swing - Blue 04 20,3x20,3

floor
 ICC - Smoke 60x60



jet black



J87645
60x120 rett. (24"x48") rect.



J87657
60x60 rett. (24"x24") rect.



J87669
30x60 rett. (12"x24") rect.

smoke



J87648
60x120 rett. (24"x48") rect.



J87660
60x60 rett. (24"x24") rect.



J87672
30x60 rett. (12"x24") rect.



J87663
30,5x60,5 (12"x24")



J87838
30x60 rett. (12"x24") rect.
15x60/10x60/5x60

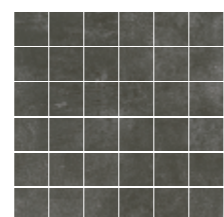

J87820 Mosaico
30x30 (12"x12")

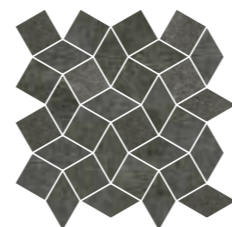

J87831 Mosaico Diamond
30x30 (12"x12")



J87666
30,5x60,5 (12"x24")



J87839
30x60 rett. (12"x24") rect.
15x60/10x60/5x60

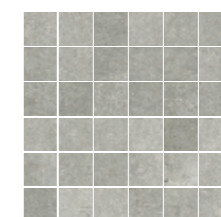

J87823 Mosaico
30x30 (12"x12")

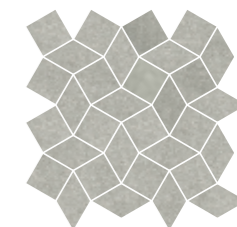

J87834 Mosaico Diamond
30x30 (12"x12")



cloud



J87644
60x120 rett. (24"x48") rect.



J87656
60x60 rett. (24"x24") rect.



J87668
30x60 rett. (12"x24") rect.



J87662
30,5x60,5 (12"x24")



J87837
30x60 rett. (12"x24") rect.
15x60/10x60/5x60



J87819 Mosaico
30x30 (12"x12")

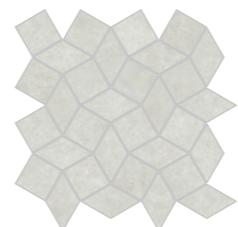

J87830 Mosaico Diamond
30x30 (12"x12")

royal blue



J87646
60x120 rett. (24"x48") rect.



J87658
60x60 rett. (24"x24") rect.



J87670
30x60 rett. (12"x24") rect.



J87664
30,5x60,5 (12"x24")



J87674
30x60 rett. (12"x24") rect.
15x60/10x60/5x60

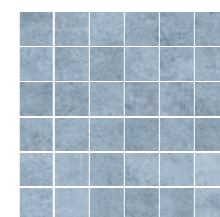

J87821 Mosaico
30x30 (12"x12")

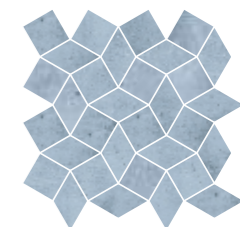

J87832 Mosaico Diamond
30x30 (12"x12")



sage



J87647
60x120 rett. (24"x48") rect.



J87659
60x60 rett. (24"x24") rect.



J87671
30x60 rett. (12"x24") rect.

turmeric



J87649
60x120 rett. (24"x48") rect.



J87661
60x60 rett. (24"x24") rect.



J87673
30x60 rett. (12"x24") rect.



J87665
30,5x60,5 (12"x24")

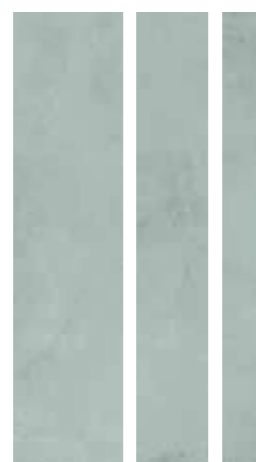

J87675
30x60 rett. (12"x24") rect.
15x60/10x60/5x60

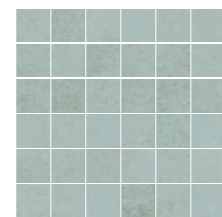

J87822 Mosaico
30x30 (12"x12")



J87833 Mosaico Diamond
30x30 (12"x12")



J87667
30,5x60,5 (12"x24")



J87676
30x60 rett. (12"x24") rect.
15x60/10x60/5x60

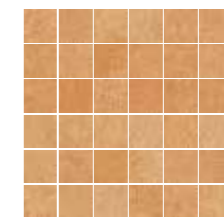

J87824 Mosaico
30x30 (12"x12")

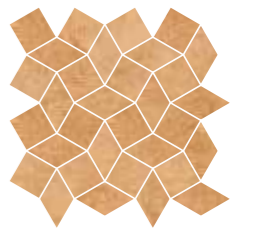

J87835 Mosaico Diamond
30x30 (12"x12")

royal blue sviluppo grafico 60x120 rett. (24"x48") rett.



12 60x120

GRAFICHE DIVERSE
DIFFERENT PATTERNS
DIFFÉRENTS MOTIFS
VERSCHIEDENE MUSTER











24 60x60

GRAFICHE DIVERSE
DIFFERENT PATTERNS
DIFFÉRENTS MOTIFS
VERSCHIEDENE MUSTER

48 30x60

GRAFICHE DIVERSE
DIFFERENT PATTERNS
DIFFÉRENTS MOTIFS
VERSCHIEDENE MUSTER

INDUSTRIAL COLOR CHIC

	 60x120 rett. (24"x48") rett.	 60x60 rett. (24"x24") rett.	 30x60 rett. (12"x24") rett.	 Modulo 30x60 rett. (12"x24") rett.	 30,5x60,5 (12"x24")
 JET BLACK	J87645	J87657	J87669	J87838	J87663
 SMOKE	J87648	J87660	J87672	J87839	J87666
 CLOUD	J87644	J87656	J87668	J87837	J87662
 ROYAL BLUE	J87646	J87658	J87670	J87674	J87664
 TURMERIC	J87649	J87661	J87673	J87676	J87667
 SAGE	J87647	J87659	J87671	J87675	J87665
SPESSORE THICKNESS	9,5 mm	9,5 mm	9,5 mm	9,5 mm	9,5 mm
KG/M²	21,20	21,14	19,00	19,44	19,04
PZ/BOX	2	3	6	5	6
M²/BOX	1,44	1,08	1,08	0,9	1,11
BOX/PALLET	32	40	48	40	48
M²/PALLET	46,08	43,20	51,84	36,00	53,28
KG/PALLET	976,96	913,2	984,96	700	1014,72
€ <1 PALLET	65,00/m²	54,00/m²	46,10/m²	90,90/m²	42,00/m²
€ >1 PALLET	56,50/m²	45,00/m²	38,40/m²	79,00/m²	35,00/m²

	 7,5x60 (3"x24")	 Mosaico Diamond 30x30 (12"x12")	 Mosaico 30x30 (12"x12")
 JET BLACK	J88260	J87831	J87820
 SMOKE	J88263	J87834	J87823
 CLOUD	J88259	J87830	J87819
 ROYAL BLUE	J88261	J87832	J87821
 TURMERIC	J88264	J87835	J87824
 SAGE	J88262	J87833	J87822
PZ/BOX	12	6	6
€/UM	9,30 pz/pce	155,50/m²	122,20/m²

Contributo spese imballo € 10,00/pal (netto). - Packing charges € 10,00/pal (net)

 0,05%
  A-HA-LA
  OK
  58,4 N/mm²
  7
  5
  Classe IV
  Classe V
  R10 B
  V2

Jet Black, Turmeric, Royal Blue, Sage
  Cloud Smoke

Dcof: Wet 0,53
Pendulum:
Dry 42 • Wet 33



LOFT

Back to Index



DARK

GREY

LIGHT GREY

WHITE

BEIGE

TAUPE



GRES PORCELLANATO A IMPASTO COLORATO
FULL BODY PORCELAIN STONWARE
GRES CERAME A PATE COLOREE
DURCHGEFÄRBTES FEINSTEINZEUG

Coordinato con:
Coordinated with:
LOFT 3D
SEZ. 3D
PG. 117



wall
Loft - Jungle Cold 40x80

floor
Loft - White 100x100

OUT

20 mm **h20**



100x100 rett.
39 1/2"x39 1/2" rect.

8,5 mm



80x80 rett.
31 1/2"x31 1/2" rect.



40x80 rett.
16"x 31 1/2" rect.

STRUTTURATO STRONG R11 / STRUCTURED STRONG R11

IN

8,5 mm



100x100 rett.
39 1/2"x39 1/2" rect.



80x80 rett.
31 1/2"x31 1/2" rect.



40x80 rett.
16"x 31 1/2" rect.



20x80 rett.
8"x 31 1/2" rect.



60x60 rett.
24"x24" rect.



30x60 rett.
12"x 24" rect.

NATURALE / NATURAL
STRUTTURATO R10 / STRUCTURED R10
STRUTTURATO LAPPATO / STRUCTURED SEMIPOLISHED



wall

Loft - White 20x80 + 40x80 + 80x80

Loft - Grey 20x80 + 40x80 + 80x80

Loft - Light Grey 20x80 + 40x80 + 80x80

floor

Loft - Grey Strutturato Lappato 100x100

dark - naturale / natural



J89042
100x100 rett. (39 1/4"x39 1/4") rect.

pompei



J89314
100x100 rett. (39 1/4"x39 1/4") rect.

dark - naturale / natural

h20



J89054 H20
100x100 rett. (39 1/4"x39 1/4") rect.
Disponibili pezzi speciali H20 a pag. 681

dark - naturale / natural



J89030
60x60 rett. (24"x24") rect.



J89018
30x60 rett. (12"x24") rect.

mosaico



J89334
30x30 (12"x12")

esagona



J89340
35x30,3 (14"x12")

dark - naturale / natural



J89066
80x80 rett. (31 1/2"x31 1/2") rect.



J89072
40x80 rett. (16"x31 1/2") rect.



J89208
20x80 rett. (8"x31 1/2") rect.

dark - strutturato r10 / structured r10



J89084
80x80 rett. (31 1/2"x31 1/2") rect.



J89090
40x80 rett. (16"x31 1/2") rect.



J89096
20x80 rett. (8"x31 1/2") rect.

dark - strutturato lappato / structured semipolished



J89132
80x80 rett. (31 1/2"x31 1/2") rect.



J89138
40x80 rett. (16"x31 1/2") rect.



J89144
20x80 rett. (8"x31 1/2") rect.

dark - strutturato strong r11 / structured strong r11



J89108
80x80 rett. (31 1/2"x31 1/2") rect.



J89114
40x80 rett. (16"x31 1/2") rect.

grey - naturale / natural



J89043
100x100 rett. (39 1/4"x39 1/4") rect.

pompei



J89315
100x100 rett. (39 1/4"x39 1/4") rect.

grey - naturale / natural

h20



J89055 H20
100x100 rett. (39 1/4"x39 1/4") rect.
Disponibili pezzi speciali H20 a pag. 681

grey - naturale / natural



J89031
60x60 rett. (24"x24") rect.



J89019
30x60 rett. (12"x24") rect.

mosaico



J89335
30x30 (12"x12")

esagona



J89341
35x30,3 (14"x12")

grey - naturale / natural



J89067
80x80 rett. (31 1/2"x31 1/2") rect.



J89073
40x80 rett. (16"x31 1/2") rect.



J89209
20x80 rett. (8"x31 1/2") rect.

grey - strutturato r10 / structured r10



J89085
80x80 rett. (31 1/2"x31 1/2") rect.



J89091
40x80 rett. (16"x31 1/2") rect.



J89097
20x80 rett. (8"x31 1/2") rect.

grey - strutturato lappato / structured semipolished



J89133
80x80 rett. (31 1/2"x31 1/2") rect.



J89139
40x80 rett. (16"x31 1/2") rect.



J89145
20x80 rett. (8"x31 1/2") rect.

grey - strutturato strong r11 / structured strong r11



J89109
80x80 rett. (31 1/2"x31 1/2") rect.



J89115
40x80 rett. (16"x31 1/2") rect.

light grey - naturale / natural



J89044
100x100 rett. (39 1/4"x39 1/4") rect.

pompei



J89316
100x100 rett. (39 1/4"x39 1/4") rect.

light grey - naturale / natural



h20



J89056 H20
100x100 rett. (39 1/4"x39 1/4") rect.

Disponibili pezzi speciali H20 a pag. 681

light grey - naturale / natural



J89031
60x60 rett. (24"x24") rect.



J89019
30x60 rett. (12"x24") rect.

mosaico

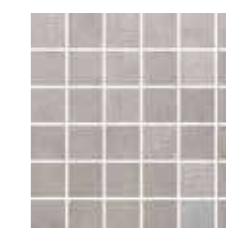

J89032
60x60 rett. (24"x24") rect.

esagona



J89342
35x30,3 (14"x12")

light grey - naturale / natural



J89068
80x80 rett. (31 1/2"x31 1/2") rect.



J89074
40x80 rett. (16"x31 1/2") rect.



J89210
20x80 rett. (8"x31 1/2") rect.

light grey - strutturato r10 / structured r10



J89086
80x80 rett. (31 1/2"x31 1/2") rect.



J89092
40x80 rett. (16"x31 1/2") rect.



J89098
20x80 rett. (8"x31 1/2") rect.

light grey - strutturato lappato / structured semipolished



J89134
80x80 rett. (31 1/2"x31 1/2") rect.



J89140
40x80 rett. (16"x31 1/2") rect.



J89146
20x80 rett. (8"x31 1/2") rect.

light grey - strutturato strong r11 / structured strong r11



J89110
80x80 rett. (31 1/2"x31 1/2") rect.



J89116
40x80 rett. (16"x31 1/2") rect.

white - naturale / natural



J89046
100x100 rett. (39 1/4"x39 1/4") rect.

pompei



J89318
100x100 rett. (39 1/4"x39 1/4") rect.

white - naturale / natural



h20



J89058 H20
100x100 rett. (39 1/4"x39 1/4") rect.

Disponibili pezzi speciali H20 a pag. 681

white - naturale / natural



J89034
60x60 rett. (24"x24") rect.



J89022
30x60 rett. (12"x24") rect.

mosaico

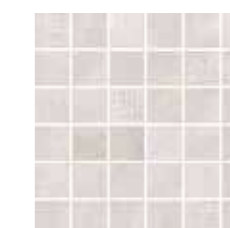

J89338
30x30 (12"x12")

esagona



J89344
35x30,3 (14"x12")

white - naturale / natural

IN R10 B



J89070
80x80 rett. (31 1/2"x31 1/2") rect. 



J89076
40x80 rett. (16"x31 1/2") rect.



J89212
20x80 rett. (8"x31 1/2") rect.

white - jungle cold

IN R10 B



J89332
40x80 rett. (16"x31 1/2") rect. - (composizione 2pz)

white - strutturato lappato / structured semipolished

IN R9 A

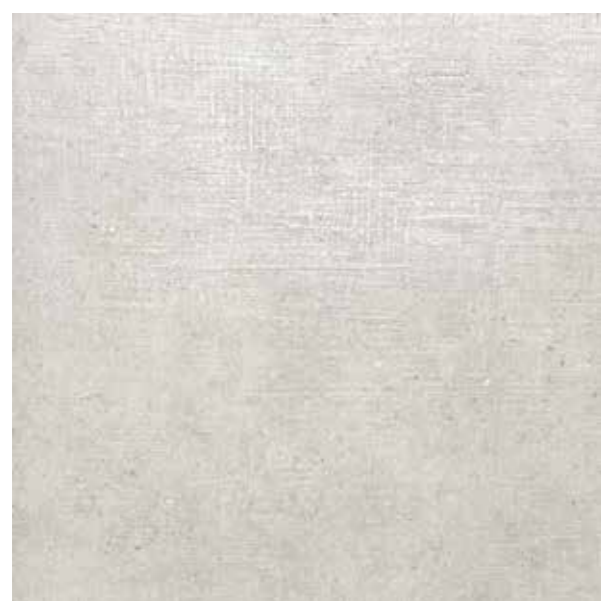

J89136
80x80 rett. (31 1/2"x31 1/2") rect.



J89142
40x80 rett. (16"x31 1/2") rect.



J89148
20x80 rett. (8"x31 1/2") rect.

white - strutturato r10 / structured r10

IN R10 B

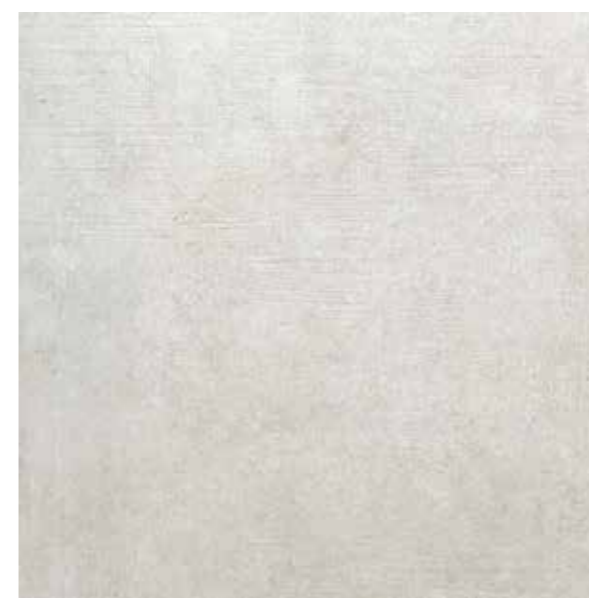

J89088
80x80 rett. (31 1/2"x31 1/2") rect.



J89094
40x80 rett. (16"x31 1/2") rect.



J89100
20x80 rett. (8"x31 1/2") rect.

J89112 Strutt. STRONG R11
80x80 rett. (31 1/2"x31 1/2") rect. 

J89118 Strutt. STRONG R11
40x80 rett. (16"x31 1/2") rect. 

beige - naturale / natural



J89041
100x100 rett. (39 1/4"x39 1/4") rect.

pompei



J89313
100x100 rett. (39 1/4"x39 1/4") rect.

beige - naturale / natural

h20



J89053 H20
100x100 rett. (39 1/4"x39 1/4") rect.

Disponibili pezzi speciali H20 a pag. 681

beige - naturale / natural



J89029
60x60 rett. (24"x24") rect.



J89017
30x60 rett. (12"x24") rect.

mosaico



J89333
30x30 (12"x12")

esagona



J89339
35x30,3 (14"x12")

beige - naturale / natural

IN R10 B



J89065
80x80 rett. (31 1/2"x31 1/2") rect. 



J89071
40x80 rett. (16"x31 1/2") rect.



J89207
20x80 rett. (8"x31 1/2") rect.

beige - jungle hot

IN R10 B



J89331
40x80 rett. (16"x31 1/2") rect. - (composizione 2pz)

beige - strutturato lappato / structured semipolished

IN R9 A



J89131
80x80 rett. (31 1/2"x31 1/2") rect.



J89137
40x80 rett. (16"x31 1/2") rect.



J89143
20x80 rett. (8"x31 1/2") rect.

beige - strutturato r10 / structured r10

IN R10 B



J89083
80x80 rett. (31 1/2"x31 1/2") rect.



J89089
40x80 rett. (16"x31 1/2") rect.



J89095
20x80 rett. (8"x31 1/2") rect.

J89107 Strutt. STRONG R11
80x80 rett. (31 1/2"x31 1/2") rect. 

J89113 Strutt. STRONG R11
40x80 rett. (16"x31 1/2") rect. 

taupe - naturale / natural



J89045
100x100 rett. (39 1/4"x39 1/4") rect.

pompei



J89317
100x100 rett. (39 1/4"x39 1/4") rect.

taupe - naturale / natural



h20



J89057 H20
100x100 rett. (39 1/4"x39 1/4") rect.

Disponibili pezzi speciali H20 a pag. 681

taupe - naturale / natural



J89033
60x60 rett. (24"x24") rect.



J89021
30x60 rett. (12"x24") rect.

mosaico



J89337
30x30 (12"x12")

esagona



J89343
35x30,3 (14"x12")

taupe - naturale / natural



J89069
80x80 rett. (31 1/2"x31 1/2") rect. IBB



J89075
40x80 rett. (16"x31 1/2") rect.



J89211
20x80 rett. (8"x31 1/2") rect.

taupe - strutturato r10 / structured r10



J89087
80x80 rett. (31 1/2"x31 1/2") rect.



J89093
40x80 rett. (16"x31 1/2") rect.



J89099
20x80 rett. (8"x31 1/2") rect.

taupe - strutturato lappato / structured semipolished



J89135
80x80 rett. (31 1/2"x31 1/2") rect.



J89141
40x80 rett. (16"x31 1/2") rect.



J89147
20x80 rett. (8"x31 1/2") rect.

taupe - strutturato strong r11 / structured strong r11



J89111
80x80 rett. (31 1/2"x31 1/2") rect.



J89117
40x80 rett. (16"x31 1/2") rect.



wall
Loft - Grey 30x60

floor
Loft - Grey 100x100

grey sviluppo grafico 100x100 rett. (39 1/4" x 39 1/4") rett.



12 100x100

GRAFICHE DIVERSE
DIFFERENT PATTERNS
DIFFÉRENTS MOTIFS
VERSCHIEDENE MUSTER

12 80x80

GRAFICHE DIVERSE
DIFFERENT PATTERNS
DIFFÉRENTS MOTIFS
VERSCHIEDENE MUSTER

24 40x80

GRAFICHE DIVERSE
DIFFERENT PATTERNS
DIFFÉRENTS MOTIFS
VERSCHIEDENE MUSTER

48 20x80







GRAFICHE DIVERSE
DIFFERENT PATTERNS
DIFFÉRENTS MOTIFS
VERSCHIEDENE MUSTER









32 60x60

GRAFICHE DIVERSE
DIFFERENT PATTERNS
DIFFÉRENTS MOTIFS
VERSCHIEDENE MUSTER

64 30x60









GRAFICHE DIVERSE
DIFFERENT PATTERNS
DIFFÉRENTS MOTIFS
VERSCHIEDENE MUSTER

							
	100x100 rett. (39 1/2"x39 1/2") rect.	h20 100x100 rett. (39 1/2"x39 1/2") rect.	80x80 rett. (31 1/2"x31 1/2") rect.	40x80 rett. (16"x31 1/2") rect.	20x80 rett. (8"x31 1/2") rect.	60x60 rett. (24"x24") rect.	30x60 rett. (12"x24") rect.
DARK	J89042	J89054	J89066	J89072	J89208	J89030	J89018
GREY	J89043	J89055	J89067	J89073	J89209	J89031	J89019
LIGHT GREY	J89044	J89056	J89068	J89074	J89210	J89032	J89020
WHITE	J89046	J89058	J89070	J89076	J89212	J89034	J89022
BEIGE	J89041	J89053	J89065	J89071	J89207	J89029	J89017
TAUPE	J89045	J89057	J89069	J89075	J89211	J89033	J89021
SPESSORE THICKNESS	8,5 mm	20 mm	8,5 mm	8,5 mm	8,5 mm	8,5 mm	8,5 mm
KG/M²	20,00	40,00	18,02	18,20	21,87	19,09	18,12
PZ/BOX	2	1	2	3	6	3	7
M²/BOX	2,00	1,00	1,28	0,96	0,96	1,08	1,26
BOX/PALLET	24	24	50	36	54	40	48
M²/PALLET	48,00	24,00	64	34,56	51,84	43,20	60,48
KG/PALLET	960	960	1153,25	629	1134	824,8	1152
€ <1 PALLET	69,00/m²	110,40/m²	65,00/m²	60,00/m²	74,80/m²	54,00/m²	46,10/m²
€ >1 PALLET	60,00/m²	96,00/m²	56,5/m²	50,00/m²	65,00/m²	45,00/m²	38,40/m²

								
	STRONG R11 80x80 rett. (31 1/2"x31 1/2") rect.	STRUTTURATO R10 80x80 rett. (31 1/2"x31 1/2") rect.	Lappato/Semipol. 80x80 rett. (31 1/2"x31 1/2") rect.	STRONG R11 40x80 rett. (16"x31 1/2") rect.	STRUTTURATO R10 40x80 rett. (16"x31 1/2") rect.	Lappato/Semipol. 40x80 rett. (16"x31 1/2") rect.	STRUTTURATO R10 20x80 rett. (8"x31 1/2") rect.	Lappato/Semipol. 20x80 rett. (8"x31 1/2") rect.
DARK	J89108	J89084	J89132	J89114	J89090	J89138	J89096	J89144
GREY	J89109	J89085	J89133	J89115	J89091	J89139	J89097	J89145
LIGHT GREY	J89110	J89086	J89134	J89116	J89092	J89140	J89098	J89146
WHITE	J89112	J89088	J89136	J89118	J89094	J89142	J89100	J89148
BEIGE	J89107	J89083	J89131	J89113	J89089	J89137	J89095	J89143
TAUPE	J89111	J89087	J89135	J89117	J89093	J89141	J89099	J89147
SPESSORE THICKNESS	8,5 mm	8,5 mm	8,5 mm	8,5 mm	8,5 mm	8,5 mm	8,5 mm	8,5 mm
KG/M²	18,07	17,86	19,06	18,20	18,20	18,20	21,87	21,87
PZ/BOX	2	2	2	3	3	3	6	6
M²/BOX	1,28	1,28	1,28	0,96	0,96	0,96	0,96	0,96
BOX/PALLET	50	50	50	36	36	36	54	54
M²/PALLET	64	64	64	34,56	34,56	34,56	51,84	51,84
KG/PALLET	1156,6	1143,6	1220	629	629	629	1134	1134
€ <1 PALLET	68,50/m²	68,50/m²	80,00/m²	61,00/m²	61,00/m²	80,00/m²	74,80/m²	84,00/m²
€ >1 PALLET	59,50/m²	59,50/m²	69,50/m²	53,00/m²	53,00/m²	69,50/m²	65,00/m²	73,00/m²

















Contributo spese imballo € 10,00/pal (netto). - Packing charges € 10,00/pal (net)

Contributo spese imballo € 20,00/pal (netto) per formato 100x100 sp. 8,5 mm - Packing charges € 20,00/pal (net) for size 100x100 th. 8,5 mm

									
	Pompei 100x100 rett. (39 1/2"x39 1/2") rect.	Jungle Hot 40x80 rett. (16"x31 1/2") rect.	Jungle Cold 40x80 rett. (16"x31 1/2") rect.	Mosaico 30x30 (12"x12")	Esagona 35x30,3 (14"x12")	Battiscopa 7,5x60 rett. (3"x24") rect.	Gradino + Toro 33x60x4 (13"x24"x1 1/2")	Gradino + Toro Dx 33x60x4 (13"x24"x1 1/2")	Gradino + Toro Sx 33x60x4 (13"x24"x1 1/2")
DARK	J89314	-	-	J89334	J89340	J89346	J89471	J89477	J89483
GREY	J89315	-	-	J89335	J89341	J89347	J89472	J89478	J89484
LIGHT GREY	J89316	-	-	J89336	J89342	J89348	J89473	J89479	J89485
WHITE	J89318	-	J89332	J89338	J89344	J89350	J89475	J89481	J89487
BEIGE	J89313	J89331	-	J89333	J89339	J89345	J89470	J89476	J89482
TAUPE	J89317	-	-	J89337	J89343	J89349	J89474	J89480	J89486
SPESSORE THICKNESS	8,5 mm	8,5 mm	8,5 mm	8,5 mm	8,5 mm	8,5 mm	8,5 mm	8,5 mm	8,5 mm
KG/M²	20,00	18,20	18,20	17,60	21,87	-	-	-	-
PZ/BOX	1	2	2	6	6	12	1	1	1
M²/BOX	1,00	0,64	0,64	0,54	0,64	-	-	-	-
BOX/PALLET	40	50	50	60	60	-	-	-	-
M²/PALLET	40,00	32	32	32,40	38,40	-	-	-	-
KG/PALLET	800	582,4	582,4	570	840	-	-	-	-
€ <1 PALLET	84,00/m²	275,00 cp	275,00 cp	140,20/m²	225,00/m²	9,30 pz/pce	88,00 pz/pce	122,80 pz/pce	122,80 pz/pce
€ >1 PALLET	73,00/m²	275,00 cp	275,00 cp	140,20/m²	225,00/m²	9,30 pz/pce	88,00 pz/pce	122,80 pz/pce	122,80 pz/pce

Contributo spese imballo € 10,00/pal (netto). - Packing charges € 10,00/pal (net)

Contributo spese imballo € 20,00/pal (netto) per formato 100x100 sp. 8,5 mm - Packing charges € 20,00/pal (net) for size 100x100 th. 8,5 mm

							
< 0,15%	A · HA · LA	OK	sp.8,5 mm > 40 N/mm² sp.20 mm > 50 N/mm²	5	Classe IV	Classe V	
LAPPATO		NATURALE		STRUTTURATO R10		h20 STRONG R11	
							
6	Dcof > 0,42 Pendulum: 25 < x < 35	7	Dcof > 0,42 Pendulum: 25 < x < 35	7	Dcof > 0,42 Pendulum > 36	8	Dcof > 0,42 Pendulum > 36

LONDON

[Back to Index](#)

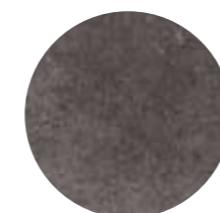

CHARCOAL



BROWN



FOG



BEIGE



SUNSET



GRES PORCELLANATO A IMPASTO COLORATO
FULL BODY PORCELAIN STONEWARE
GRES CERAME A PATE COLOREE
DURCHGEFÄRBTES FEINSTEINZEUG

Coordinato con:
Coordinated with:
LONDON
SEZ. BRICK GENERATION
PG. 31



30,5x60,5
12"x24"

wall
London - Charcoal 30,5x60,5
London - Fog 30,5x60,5

floor
London - Charcoal 30,5x60,5

IN OUT R10/B

IN OUT R10/B

charcoal



J86017
30,5x60,5 (12"x24")



J86027 Mosaico
30x30 (12"x12")

Coordinato con:
Coordinated with:
LONDON
SEZ. BRICK GENERATION
PG. 31



J85880
6x25 (2 1/3"x10")



J85940
13x25 (5"x10")

fog



J85946
30,5x60,5 (12"x24")



J86028 Mosaico
30x30 (12"x12")

Coordinato con:
Coordinated with:
LONDON
SEZ. BRICK GENERATION
PG. 31



J85881
6x25 (2 1/3"x10")



J85941
13x25 (5"x10")

brown



J85945
30,5x60,5 (12"x24")



J86026
30x30 (12"x12")

Coordinato con:
Coordinated with:
LONDON
SEZ. BRICK GENERATION
PG. 31



J85879
6x25 (2 1/3"x10")



J85939
13x25 (5"x10")

beige



J85944
30,5x60,5 (12"x24")



J86025 Mosaico
30x30 (12"x12")

Coordinato con:
Coordinated with:
LONDON
SEZ. BRICK GENERATION
PG. 31



J85878
6x25 (2 1/3"x10")



J85938
13x25 (5"x10")

IN OUT R10 B

sunset

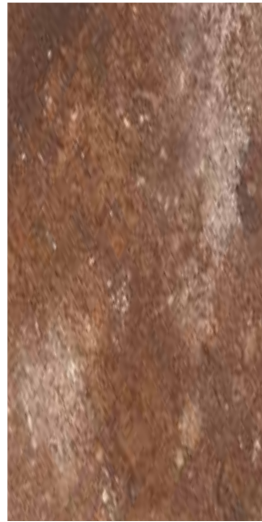

J85947
30,5x60,5 (12"x24")



J86029 Mosaico
30x30 (12"x12")

Coordinato con:
Coordinated with:

LONDON
SEZ. BRICK GENERATION
PG. 31



J85931
6x25 (2 1/8"x10")



J85943
13x25 (5"x10")



floor
London - Brown 30,5x60,5

FOG sviluppo grafico 30,5x60,5 (12"x24")



24 30,5x60,5

GRAFICHE DIVERSE
DIFFERENT PATTERNS
DIFFÉRENTS MOTIFS
VERSCHIEDENE MUSTER

	30,5x60,5 (12"x24")	Mosaico 30x30 (12"x12")	Battiscopa 7,5x60,5 (3"x24")	13x25 (5"x10")	6x25 (2 1/8"x10")
CHARCOAL	J86017	J86027	J86266	J85940	J85880
BROWN	J85945	J86026	J86265	J85939	J85879
FOG	J85946	J86028	J86267	J85941	J85881
BEIGE	J85944	J86025	J86264	J85938	J85878
SUNSET	J85947	J86029	J86268	J85943	J85931
SPESSORE THICKNESS	9,5 mm	9,5 mm	9,5 mm	9,5 mm	9,5 mm
KG/M²	20	20	-	19,23	16,9
PZ/BOX	6	6	12	16	32
M²/BOX	1,11	-	-	0,52	0,58 *
BOX/PALLET	48	-	-	100	100
M²/PALLET	53,28	-	-	52	58
KG/PALLET	1065,6	-	-	1000	980,2
€ <1 PALLET	46,10/m²	154,50/m²	9,30 pz./p.ce	55,70/m²	64,90/m²
€ ≥1 PALLET	38,40/m²	154,50/m²	9,30 pz./p.ce	46,40/m²	56,40/m²

Contributo spese imballo € 10,00/pal (netto). - Packing charges € 10,00/pal (net)

* Compresa fuga di 1 cm - 1 cm joint included



0,3%



A • HA • LA



OK



46,35 N/mm²



6



5



Classe IV



Classe V



Dcof: Wet 0,62
Pendulum:
Dry 51 • Wet 42



V3



floor
Manhattan - Blu 80x80

[Back to Index](#)

MANHATTAN



BLU



LIGHT GREY



WHITE



IVORY



COTTO



TAUPE



GRES PORCELLANATO SMALTATO
GLAZED PORCELAIN STONEWARE
GRES CERAME EMAILLE
GLASIERTESFEINSTEINZEUG

Coordinato con:
Coordinated with:
SOHO - NOHO
SEZ. BRICK GENERATION
PG. 53

8,5 mm



80x80 rett.
31 ½"x31 ½" rect.



40x80 rett.
16"x31 ½" rect.



wall
Soho - Sage 6x25

floor
Manhattan - Cotto 80x80



blu



J89745
80x80 rett. (31 1/2"x31 1/2") rect.



J89991
40x80 rett. (16"x31 1/2") rect.

ivory

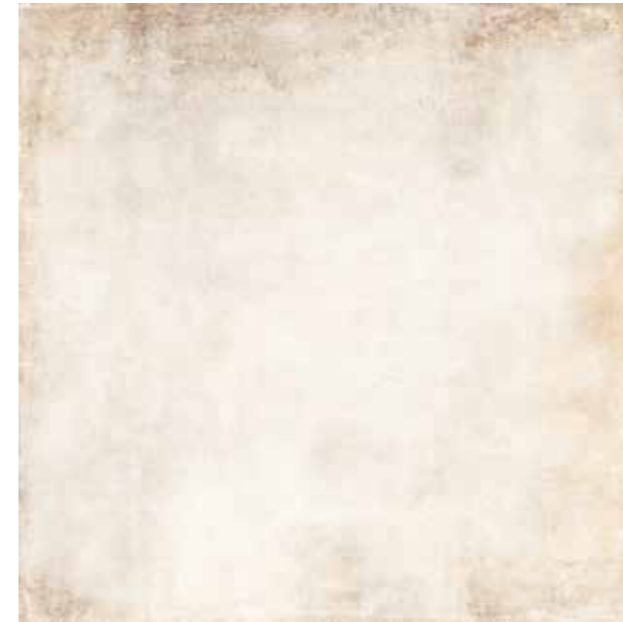

J89747
80x80 rett. (31 1/2"x31 1/2") rect.



J89993
40x80 rett. (16"x31 1/2") rect.

light grey

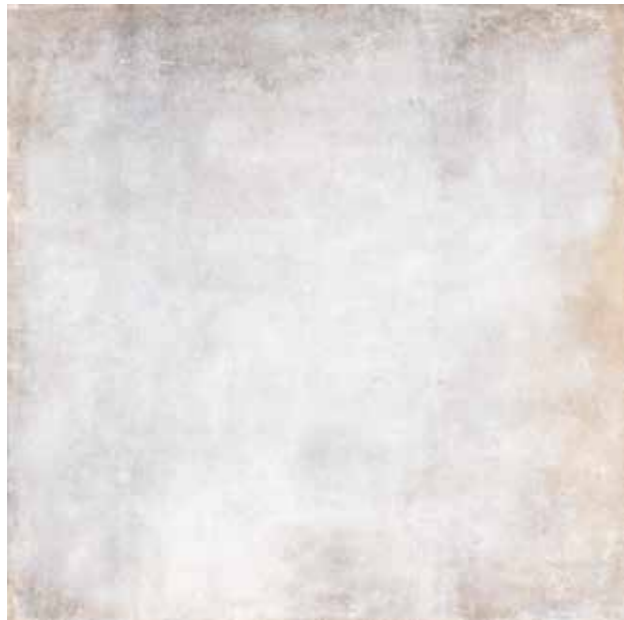

J89748
80x80 rett. (31 1/2"x31 1/2") rect.



J89994
40x80 rett. (16"x31 1/2") rect.

white

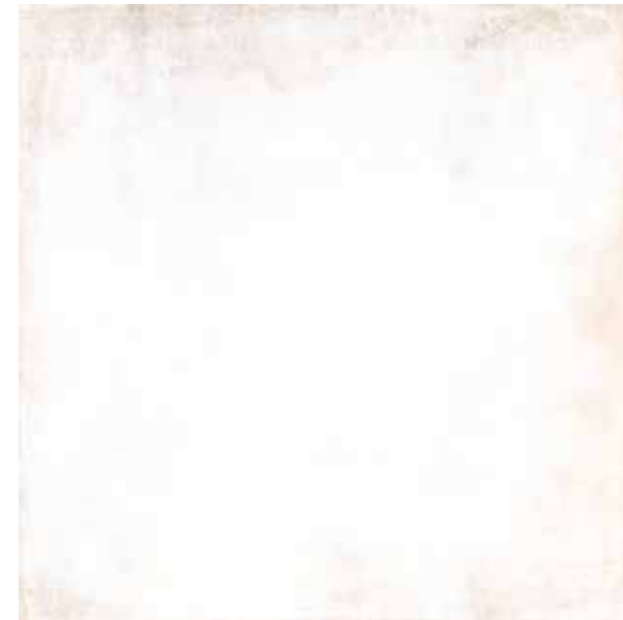

J89750
80x80 rett. (31 1/2"x31 1/2") rect.

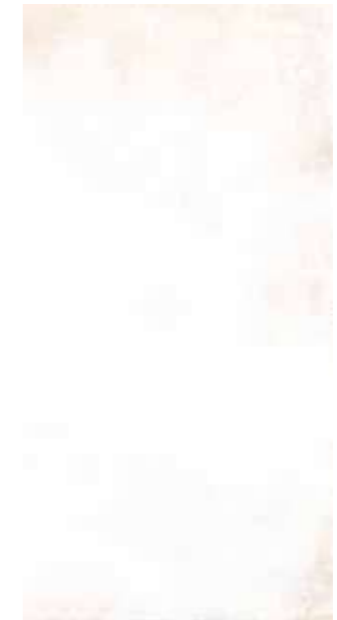

J89996
40x80 rett. (16"x31 1/2") rect.



cotto



J89746
80x80 rett. (31 1/2"x31 1/2") rect.



J89992
40x80 rett. (16"x31 1/2") rect.

taupe



J89749
80x80 rett. (31 1/2"x31 1/2") rect.











J89995
40x80 rett. (16"x31 1/2") rect.

blu sviluppo grafico 80x80 rett. (31¹/₂"x31¹/₂") rect.



10 80x80

GRAFICHE DIVERSE
DIFFERENT PATTERNS
DIFFÉRENTS MOTIFS
VERSCHIEDENE MUSTER

	 80x80 rett. (31 ¹ / ₂ "x31 ¹ / ₂ ") rect.	 40x80 rett. (16"x31 ¹ / ₂ ") rect.	 Battiscopa 7,5x80 rett. (3"x31 ¹ / ₂ ") rect.
 BLU	J89745	J89991	J89997
 LIGHT GREY	J89748	J89994	J90000
 WHITE	J89750	J89996	J90002
 IVORY	J89747	J89993	J89999
 TAUPE	J89749	J89995	J90001
 COTTO	J89746	J89992	J89998
SPESSORE THICKNESS	8,5 mm	8,5 mm	-
KG/M ²	17,81	18,20	-
PZ/BOX	2	3	12
M ² /BOX	1,28	0,96	-
BOX/PALLET	50	36	-
M ² /PALLET	64	34,56	-
KG/PALLET	1140	629	-
€ <1 PALLET	65,00 / m ²	60,00/m ²	12,00 pz/pce
€ >1 PALLET	56,50 / m ²	50,00/m ²	12,00 pz/pce

Contributo spese imballo € 10,00/pal (netto). - Packing charges € 10,00/pal (net)

 0,1%
  A • HA • LA
  OK
  > 45 N/mm²
  7
  5
  Blu, Cotto, Taupe Classe IV
  Ivory, Light Grey, White Classe V
  R10 B
  V2
 Dcof: > 0,42
Pendulum:
Dry/Wet > 36

MURALES

[Back to Index](#)

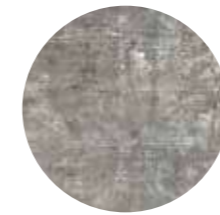

DARK



GREY



ICE

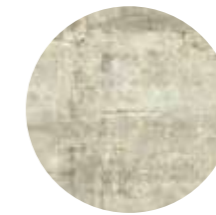

BEIGE



GRES PORCELLANATO A IMPASTO COLORATO
FULL BODY PORCELAIN STONEWARE
GRES CERAME A PATE COLOREE
DURCHGEFÄRBTES FEINSTEINZEUG

8,5 mm



100x100 rett.
39 1/4"x39 1/4" rect.

9,5 mm



60x120 rett.
24"x48" rect.



80x80 rett.
31 1/2"x31 1/2" rect.



40x80 rett.
16"x31 1/2" rect.

floor
Murales - Dark 80x80
Murales - Decoro Dark 80x80



dark



J87899
60x120 rett. (24"x48") rect.



J89428
100x100 rett. (39 1/4"x39 1/4") rect.



J88195 Decoro Brass
60x120 rett. (24"x48") rect.



J88321 Mosaico
30x30 (12"x12")



J87996
80x80 rett. (31 1/2"x31 1/2") rect.



J88000
40x80 rett. (16"x31 1/2") rect.



J88135 Decoro
80x80 rett. (31 1/2"x31 1/2") rect.



grey



J87900
60x120 rett. (24"x48") rect.



J89429
100x100 rett. (39 1/4"x39 1/4") rect.



J88196 Decoro Brass
60x120 rett. (24"x48") rect.



J88322 Mosaico
30x30 (12"x12")



J87997
80x80 rett. (31 1/2"x31 1/2") rect.



J88001
40x80 rett. (16"x31 1/2") rect.



J88136 Decoro
80x80 rett. (31 1/2"x31 1/2") rect.



ice



J87901
60x120 rett. (24"x48") rect.



J89430
100x100 rett. (39 1/4"x39 1/4") rect.



J88197 Decoro Brass
60x120 rett. (24"x48") rect.



J88323 Mosaico
30x30 (12"x12")



J87998
80x80 rett. (31 1/2"x31 1/2") rect.



J88002
40x80 rett. (16"x31 1/2") rect.



J88137 Decoro
80x80 rett. (31 1/2"x31 1/2") rect.



J88336 Bombay Ice
40x80 rett. (16"x31 1/2") rect.



beige



J87898
60x120 rett. (24"x48") rect.



J89427
100x100 rett. (39 1/4"x39 1/4") rect.



J88194 Decoro Brass
60x120 rett. (24"x48") rect.



J88320 Mosaico
30x30 (12"x12")



J87995
80x80 rett. (31 1/2"x31 1/2") rect.



J87999
40x80 rett. (16"x31 1/2") rect.



J88134 Decoro
80x80 rett. (31 1/2"x31 1/2") rect.



J88335 Bombay Beige
40x80 rett. (16"x31 1/2") rect.

ice sviluppo grafico 60x120 rett. (24"x48") rett.

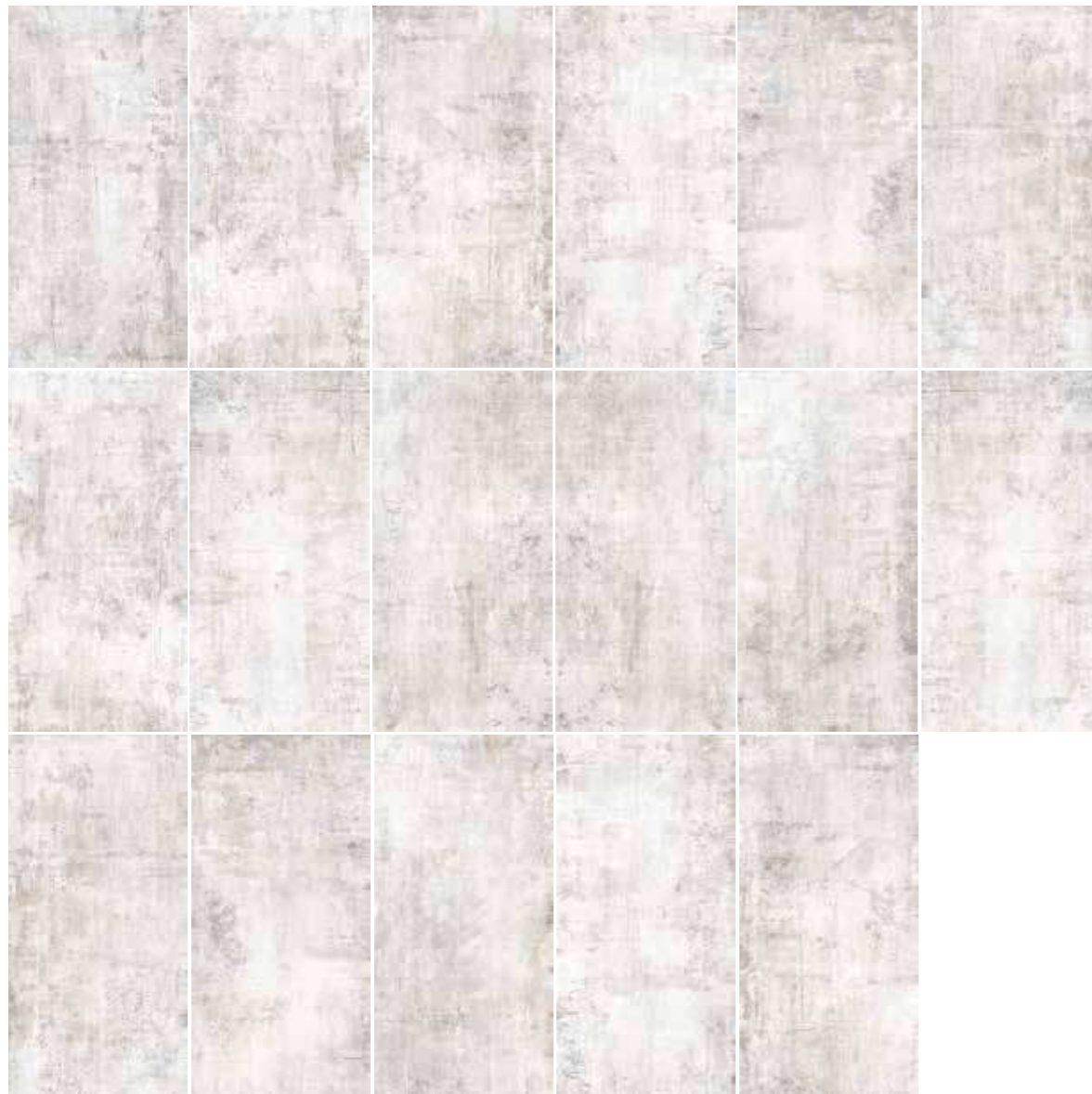

17 60x120

GRAFICHE DIVERSE
DIFFERENT PATTERNS
DIFFÉRENTS MOTIFS
VERSCHIEDENE MUSTER

10 100x100

GRAFICHE DIVERSE
DIFFERENT PATTERNS
DIFFÉRENTS MOTIFS
VERSCHIEDENE MUSTER

14 80x80

GRAFICHE DIVERSE
DIFFERENT PATTERNS
DIFFÉRENTS MOTIFS
VERSCHIEDENE MUSTER

28 40x80

GRAFICHE DIVERSE
DIFFERENT PATTERNS
DIFFÉRENTS MOTIFS
VERSCHIEDENE MUSTER

	60x120 rett. (24"x48") rect.	100x100 rett. (39 1/4"x39 1/4") rect.	80x80 rett. (31 1/2"x31 1/2") rect.	40x80 rett. (16"x31 1/2") rect.	Decoro 80x80 rett. (31 1/2"x31 1/2") rect.
DARK	J87899	J89428	J87996	J88000	J88135
GREY	J87900	J89429	J87997	J88001	J88136
ICE	J87901	J89430	J87998	J88002	J88137
BEIGE	J87898	J89427	J87995	J87999	J88134
SPESSORE THICKNESS	9,5 mm	8,5 mm	9,5 mm	9,5 mm	9,5 mm
KG/M²	21,60	20,00	20,67	20,55	20,92
PZ/BOX	2	2	2	3	2
M²/BOX	1,44	2,00	1,28	0,96	1,28
BOX/PALLET	32	24	40	33	40
M²/PALLET	46,08	48,00	51,20	31,68	51,20
KG/PALLET	995,52	960	1058,4	651,09	1071,2
€ <1 PALLET	65,00/m²	69,00/m²	65,00/m²	60,00/m²	76,40/m²
€ >1 PALLET	56,50/m²	60,00/m²	56,50/m²	50,00/m²	66,40/m²

	Brass 60x120 (24"x48")	Mosaico 30x30 (12"x12")	Bombay 40x80 (16"x31 1/2")	Battiscopa 7,5x60 (3"x24")
DARK	J88195	J88321	-	J88266
GREY	J88196	J88322	-	J88267
ICE	J88197	J88323	J88336	J88268
BEIGE	J88194	J88320	J88335	J88265
PZ/BOX	2	6	2	12
€/UM	179,00 pz /pce	122,20/m²	86,50 pz/pce	9,30 pz/pce

Contributo spese imballo € 10,00/pal (netto). - Packing charges € 10,00/pal (net)

Contributo spese imballo € 20,00/pal (netto) per formato 100x100 sp. 8,5 mm - Packing charges € 20,00/pal (net) for size 100x100 th. 8,5 mm

0,1%
 A · HA · LA
 OK
 50,1 N/mm²
 7
 5
 4
 5
 R10 B
 V4

Dark Grey
 Classe IV
 Classe V
 Dcof: Wet 0,63
 Pendulum:
 Dry 45 · Wet 30



wall
Oxyd - Tendina Corten 20x120

floor
Oxyd - Grey 20x120 Full Lapp.

[Back to Index](#)

OXYD



DARK



GREY

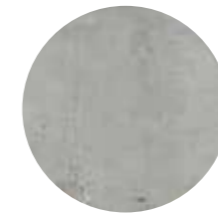

LIGHT GREY



WHITE

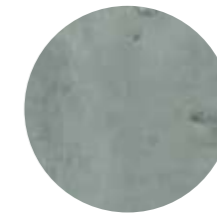

GREEN



CORTEN



GRES PORCELLANATO A IMPASTO COLORATO
FULL BODY PORCELAIN STONEWARE
GRES CERAME A PATE COLOREE
DURCHGEFÄRBTES FEINSTEINZEUG

9,5 mm

NATURALE / NATURAL
FULL LAPPATO / POLISHED



60x120 rett.
24"x48" rect.



20x120 rett.
8"x48" rect.



60x60 rett.
24"x24" rect.



30x60 rett.
12"x24" rect.

8 mm



6,1x37
2 3/8"x14 1/2"

dark



J88019
60x120 rett. (24"x48") rect.
J88211 Full Lap./Polished
60x120 rett. (24"x48") rect.



J88025
20x120 rett. (8"x48") rect.



J88117 Tendina
20x120 (8"x48") rect.



J88037
60x60 rett. (24"x24") rect.



J88049
30x60 rett. (12"x24") rect.



J88055
6,1x37 (2 2/5"x14 1/2")



J88129 Mosaico
30x30 (12"x12")

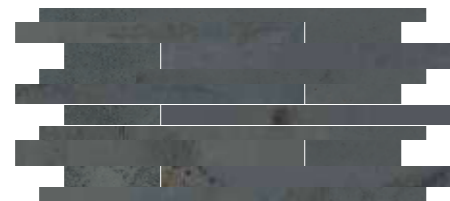

J88123 Muretto
30x60 (12"x24")

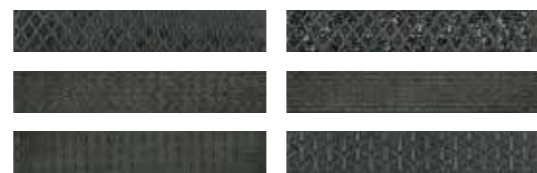

J88199 Reactive Mix
6,1x37 (2 2/5"x14 1/2")

grey



J88021
60x120 rett. (24"x48") rect.
J88213 Full Lap./Polished
60x120 rett. (24"x48") rect.



J88027
20x120 rett. (8"x48") rect.

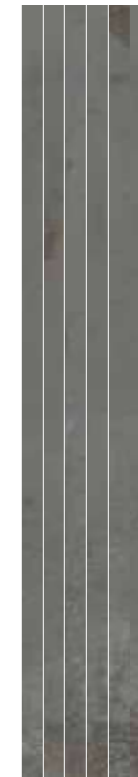

J88119 Tendina
20x120 (8"x48") rect.



J88039
60x60 rett. (24"x24") rect.



J88051
30x60 rett. (12"x24") rect.



J88057
6,1x37 (2 2/5"x14 1/2")

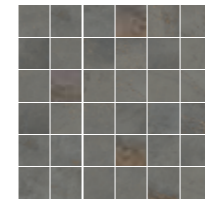

J88131 Mosaico
30x30 (12"x12")

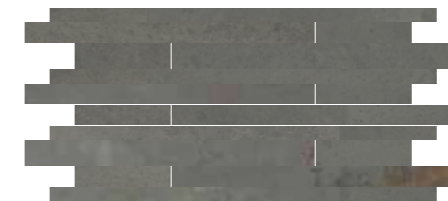

J88125 Muretto
30x60 (12"x24")



J88201 Reactive Mix
6,1x37 (2 2/5"x14 1/2")

light grey



J88022
60x120 rett. (24"x48") rect.

J88214 Full Lap./Polished
60x120 rett. (24"x48") rect.



J88028
20x120 rett. (8"x48") rect.



J88120 Tendina
20x120 (8"x48")



J88040
60x60 rett. (24"x24") rect.



J88052
30x60 rett. (12"x24") rect.



J88058
6,1x37 (2 2/5"x14 1/2")



J88132 Mosaico
30x30 (12"x12")

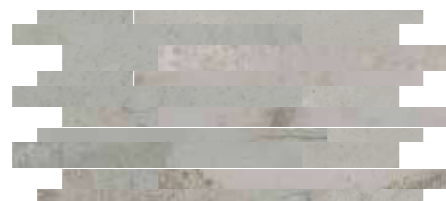

J88126 Muretto
30x60 (12"x24")

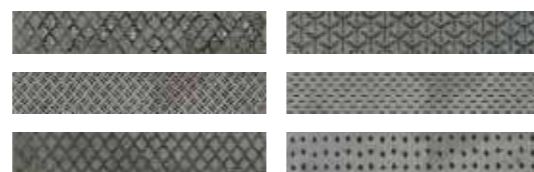

J88202 Reactive Mix
6,1x37 (2 2/5"x14 1/2")

white



J88023
60x120 rett. (24"x48") rect.

J88215 Full Lap./Polished
60x120 rett. (24"x48") rect.



J88029
20x120 rett. (8"x48") rect.



J88121 Tendina
20x120 (8"x48")



J88041
60x60 rett. (24"x24") rect.



J88053
30x60 rett. (12"x24") rect.

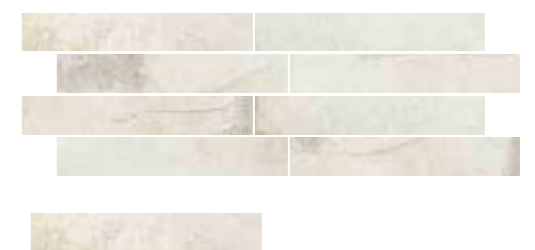

J88059
6,1x37 (2 2/5"x14 1/2")

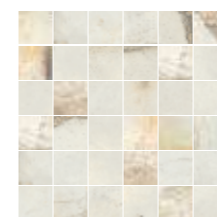

J88133 Mosaico
30x30 (12"x12")

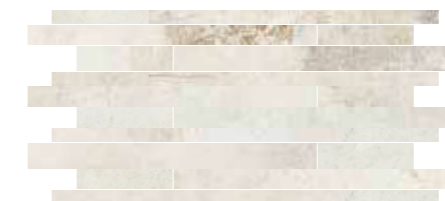

J88127 Muretto
30x60 (12"x24")



J88203 Reactive Mix
6,1x37 (2 2/5"x14 1/2")

green



J88020
60x120 rett. (24"x48") rect.

J88212 Full Lap./Polished
60x120 rett. (24"x48") rect.



J88026
20x120 rett. (8"x48") rect.



J88118 Tendina
20x120 (8"x48") rect.



J88038
60x60 rett. (24"x24") rect.



J88050
30x60 rett. (12"x24") rect.



J88056
6,1x37 (2 2/5"x14 1/2") rect.

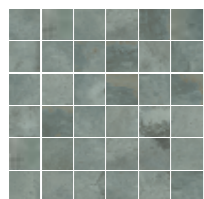

J88130 Mosaico
30x30 (12"x12")

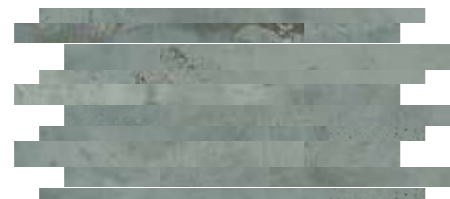

J88124 Muretto
30x60 (12"x24")



J88200 Reactive Mix
6,1x37 (2 2/5"x14 1/2")

corten



J88018
60x120 rett. (24"x48") rect.

J88210 Full Lap./Polished
60x120 rett. (24"x48") rect.



J88024
20x120 rett. (8"x48") rect.

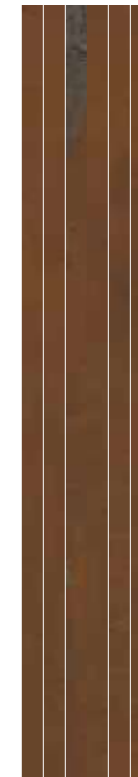

J88116 Tendina
20x120 (8"x48") rect.



J88036
60x60 rett. (24"x24") rect.



J88048
30x60 rett. (12"x24") rect.



J88054
6,1x37 (2 2/5"x14 1/2")

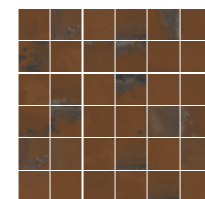

J88128 Mosaico
30x30 (12"x12")

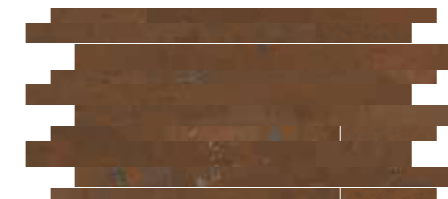

J88122 Muretto
30x60 (12"x24")



J88198 Reactive Mix
6,1x37 (2 2/5"x14 1/2")

grey sviluppo grafico 60x120 rett. (24"x48") rett.



12 60x120

GRAFICHE DIVERSE

DIFFERENT PATTERNS
DIFFÉRENTS MOTIFS
VERSCHIEDENE MUSTER

30 60x60

GRAFICHE DIVERSE

DIFFERENT PATTERNS
DIFFÉRENTS MOTIFS
VERSCHIEDENE MUSTER

36 20x120

GRAFICHE DIVERSE

DIFFERENT PATTERNS
DIFFÉRENTS MOTIFS
VERSCHIEDENE MUSTER

60 30x60

GRAFICHE DIVERSE

DIFFERENT PATTERNS
DIFFÉRENTS MOTIFS
VERSCHIEDENE MUSTER

68 6,1x37

GRAFICHE DIVERSE

DIFFERENT PATTERNS
DIFFÉRENTS MOTIFS
VERSCHIEDENE MUSTER

	60x120 rett. (24"x48") rect.	Full Lappato 60x120 rett. (24"x48") rect.	20x120 rett. (8"x48") rect.	60x60 rett. (24"x24") rect.	30x60 rett. (12"x24") rect.	6,1x37 (2 2/5"x14 1/2")	Tendina 20x120 rett. (8"x48") rect.	Muretto 30x60 (12"x24")	Mosaico 30x30 (12"x12")	Reactive Mix 6,1x37 (2 2/5"x14 1/2")
DARK	J88019	J88211	J88025	J88037	J88049	J88055	J88117	J88123	J88129	J88199
GREY	J88021	J88213	J88027	J88039	J88051	J88057	J88119	J88125	J88131	J88201
LIGHT GREY	J88022	J88214	J88028	J88040	J88052	J88058	J88120	J88126	J88132	J88202
WHITE	J88023	J88215	J88029	J88041	J88053	J88059	J88121	J88127	J88133	J88203
GREEN	J88020	J88212	J88026	J88038	J88050	J88056	J88118	J88124	J88130	J88200
CORTEN	J88018	J88210	J88024	J88036	J88048	J88054	J88116	J88122	J88128	J88198
SPESSORE THICKNESS	9,5 mm	9,5 mm	9,5 mm	9,5 mm	9,5 mm	8 mm	9,5 mm	9,5 mm	9,5 mm	8 mm
KG/M²	21,38	21,38	22,19	21,25	21,16	16,1	22,19	21,16	21,16	16,1
PZ/BOX	2	2	4	3	6	48	4	4	6	6
M²/BOX	1,44	1,44	0,96	1,08	1,08	1,08	0,96	0,72	0,54	0,14
BOX/PALLET	32	36	48	40	48	60	-	-	-	-
M²/PALLET	46,08	51,84	46,08	43,20	51,84	64,80	-	-	-	-
KG/PALLET	985,3	1108	976,8	918	1097,3	1044	-	-	-	-
€ <1 PALLET	65,00/m²	92,00/m²	72,50/m²	60,00/m²	56,10/m²	55,70/m²	140,20/m²	122,20/m²	122,20/m²	10,50 pz/pce
€ >1 PALLET	56,50/m²	80,00/m²	63,00/m²	50,00/m²	46,70/m²	46,40/m²	140,20/m²	122,20/m²	122,20/m²	10,50 pz/pce

	Battiscopa 7,5x60 rett. (3"x24")	Gradino+Toro 33x120x4 (13"x48"x1 1/2")	Angolo+Toro Dx 33x120x4 (13"x48"x1 1/2")	Angolo+Toro Sx 33x120x4 (13"x48"x1 1/2")	Battiscopa Lapp. 7,5x60 (3"x24")	Gradino+Toro Lapp. 33x120x4 (13"x48"x1 1/2")	Angolo+Toro Dx Lapp. 33x120x4 (13"x48"x1 1/2")	Angolo+Toro Sx Lapp. 33x120x4 (13"x48"x1 1/2")
DARK	J88278	J88687	J88693	J88699	J88284	J88705	J88711	J88717
GREY	J88280	J88689	J88695	J88701	J88286	J88707	J88713	J88719
LIGHT GREY	J88281	J88690	J88696	J88702	J88287	J88708	J88714	J88720
WHITE	J88282	J88691	J88697	J88703	J88288	J88709	J88715	J88721
GREEN	J88279	J88688	J88694	J88700	J88285	J88706	J88712	J88718
CORTEN	J88277	J88686	J88692	J88698	J88283	J88704	J88710	J88716
PZ/BOX	12	2	1	1	12	2	1	1
€/UM	9,30 pz/pce	179,00 pz/pce	239,00 pz/pce	239,00 pz/pce	12,00 pz/pce	195,00 pz/pce	254,00 pz/pce	254,00 pz/pce

Contributo spese imballo € 10,00/pal (netto). - Packing charges € 10,00/pal (net)

< 0,1%
 A • HA • LA
 OK
 > 50 N/mm²
 6
 5
 FULL LAPPATO
 3 Classe III
 4 Classe IV
 5 Classe V
 R9 A
 V3
 Dcof: Wet 0,42
 Pendulum: Dry 41 • Wet 25

RUST

[Back to Index](#)

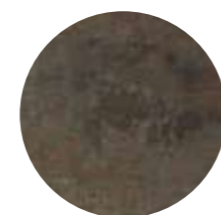

COAL



STEEL



DUST



MUSK

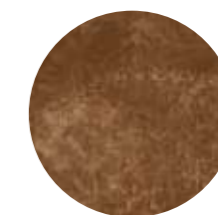

CORTEN



GRES PORCELLANATO A IMPASTO COLORATO
FULL BODY PORCELAIN STONEWARE
GRES CERAME A PATE COLOREE
DURCHGEFÄRBTES FEINSTEINZEUG

9,5 mm



60x60 rett.
24"x24" rect.



60,5x60,5
24"x24"



30x60 rett.
12"x24" rect.



30,5x60,5
12"x24"

floor
Rust - Steel 60x60



coal



J85632
60,5x60,5 (24"x24")



J85642
30,5x60,5 (12"x24")



J85637
60x60 rett. (24"x24") rect.



J85647
30x60 rett. (12"x24") rect.



J85905 Tozzetto Mix
15x15 (6"x6")



J85900 Inserto Mix
30x60 rett. (12"x24") rect.



J85910 Fascia
6x30 (2 1/3"x12")

wall
Rust - Coal 60x60+Fascia Coal 6x30
Rust - Dust 30x60

floor
Rust - Coal 60x60+Fascia Coal 6x30

steel



J85636
60,5x60,5 (24"x24")



J85646
30,5x60,5 (12"x24")



J85641
60x60 rett. (24"x24") rect.



J85651
30x60 rett. (12"x24") rect.

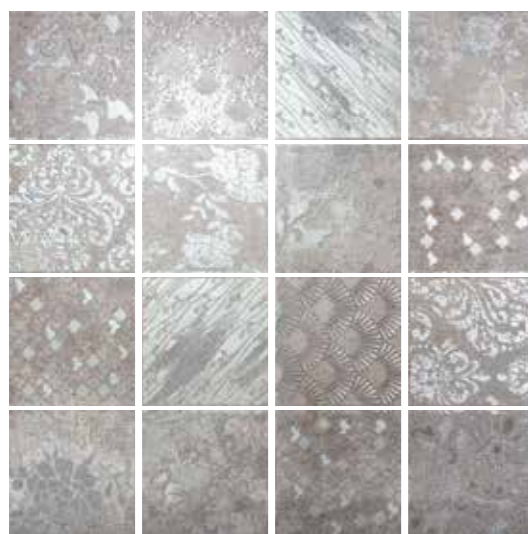

J85909 Tozzetto Mix
15x15 (6"x6")



J85904 Inserto Mix
30x60 rett. (12"x24") rect.



J85914 Fascia
6x30 (2 1/3"x12")

dust



J85634
60,5x60,5 (24"x24")



J85644
30,5x60,5 (12"x24")



J85639
60x60 rett. (24"x24") rect.



J85649
30x60 rett. (12"x24") rect.



J85907 Tozzetto Mix
15x15 (6"x6")



J85902 Inserto Mix
30x60 rett. (12"x24") rect.



J85912 Fascia
6x30 (2 1/3"x12")

musk



J85635
60,5x60,5 (24"x24")



J85645
30,5x60,5 (12"x24")



J85640
60x60 rett. (24"x24") rect.



J85650
30x60 rett. (12"x24") rect.



J85908 Tozzetto Mix
15x15 (6"x6")



J85903 Inserto Mix
30x60 rett. (12"x24") rect.



J85913 Fascia
6x30 (2 1/3"x12")

corten



J85633
60,5x60,5 (24"x24")



J85643
30,5x60,5 (12"x24")



J85638
60x60 rett. (24"x24") rect.



J85648
30x60 rett. (12"x24") rect.



J85906 Tozzetto Mix
15x15 (6"x6")



J85901 Inserto Mix
30x60 rett. (12"x24") rect.



J85911 Fascia
6x30 (2 1/3"x12")

coal sviluppo grafico 60x60 rett. (24"x24") rett.



27 60x60









GRAFICHE DIVERSE

DIFFERENT PATTERNS
DIFFÉRENTS MOTIFS
VERSCHIEDENE MUSTER

54 30x60

GRAFICHE DIVERSE

DIFFERENT PATTERNS
DIFFÉRENTS MOTIFS
VERSCHIEDENE MUSTER

	 60,5x60,5 (24"x24")	 60x60 rett. (24"x24") rect.	 30,5x60,5 (12"x24")	 30x60 rett. (12"x24") rect.
 COAL	J85632	J85637	J85642	J85647
 STEEL	J85636	J85641	J85646	J85651
 DUST	J85634	J85639	J85644	J85649
 MUSK	J85635	J85640	J85645	J85650
 CORTEN	J85633	J85638	J85643	J85648
SPESSORE THICKNESS	9,5 mm	9,5 mm	9,5 mm	9,5 mm
KG/M²	23,5	23,5	18,8	20
PZ/BOX	3	3	6	6
M²/BOX	1,10	1,08	1,11	1,08
BOX/PALLET	40	40	48	48
M²/PALLET	44	43,20	53,28	51,84
KG/PALLET	1034	1016	1001,7	1036,8
€ <1 PALLET	54,00/m²	60,00/m²	50,00/m²	56,10/m²
€ >1 PALLET	45,00/m²	50,00/m²	41,70/m²	46,70/m²

	 Battiscopa 7,5x60 (3"x24")	 Tozzetto Mix 15x15 (6"x6")	 Inserto Mix 30x60 rett. (12"x24") rect.	 Fascia 6x30 (2 1/8" x12")
 COAL	J85652	J85905	J85900	J85910
 STEEL	J85656	J85909	J85904	J85914
 DUST	J85654	J85907	J85902	J85912
 MUSK	J85655	J85908	J85903	J85913
 CORTEN	J85653	J85906	J85901	J85911
PZ/BOX	12	8	4	6
€ /UM	9,30 pz /pce	13,50 pz/pce	71,00 pz/pce	13,50 pz/pce

Contributo spese imballo € 10,00/pal (netto). - Packing charges € 10,00/pal (net)

 0,2%
  A • HA • LA
  OK
  > 40 N/mm²
  8
  5
  Coal 4
  5
  R9 A
  V3

Dcof: Wet 0,53
Pendulum:
Dry 41 • Wet 27



floor
Swing - Night&Day 20,3x20,3
Oxid - Dark 60x120

SWING

[Back to Index](#)

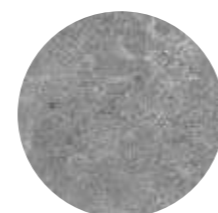

DARK

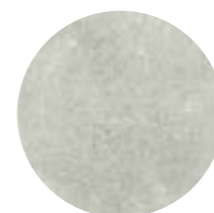

GREY



WHITE



ICE



ALMOND



GRES PORCELLANATO A IMPASTO COLORATO
FULL BODY PORCELAIN STONEWARE
GRES CERAME A PATE COLOREE
DURCHGEFÄRBTES FEINSTEINZEUG



SMART
EDGE



20,3x20,3
8"x8"

blue 01



1 SOGGETTO - 1 PATTERN
(30pz per scatola - 30 pieces per box)

J87776
20,3x20,3 (8"x8")

blue 02

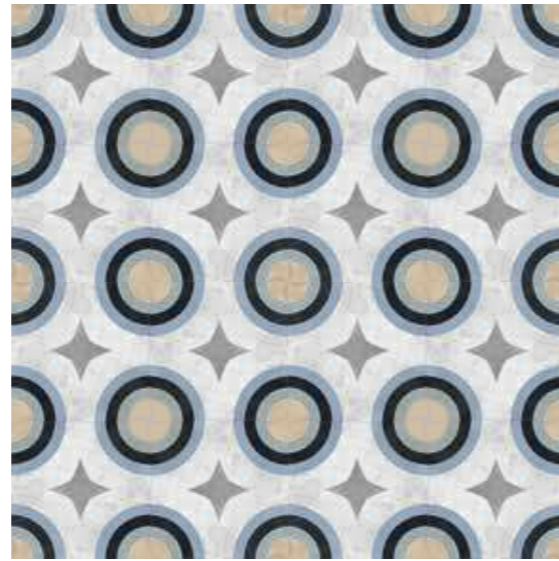

1 SOGGETTO - 1 PATTERN
(30pz per scatola - 30 pieces per box)

J87779
20,3x20,3 (8"x8")

blue mix



J87773
20,3x20,3 (8"x8")

19 SOGGETTI - 19 PATTERNS
(30pz random per scatola
30 random pieces per box)



blue 03



1 SOGGETTO - 1 PATTERN
(30pz per scatola - 30 pieces per box)

J87782
20,3x20,3 (8"x8")

blue 04

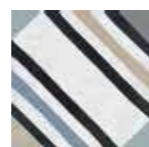

1 SOGGETTO - 1 PATTERN
(30pz per scatola - 30 pieces per box)

J87785
20,3x20,3 (8"x8")

dark



J87769
20,3x20,3 (8"x8")

grey



J87770
20,3x20,3 (8"x8")

white



J87771
20,3x20,3 (8"x8")

night and day 01



1 SOGGETTO - 1 PATTERN
(30pz per scatola - 30 pieces per box)

J87810
20,3x20,3 (8"x8")

night and day 02

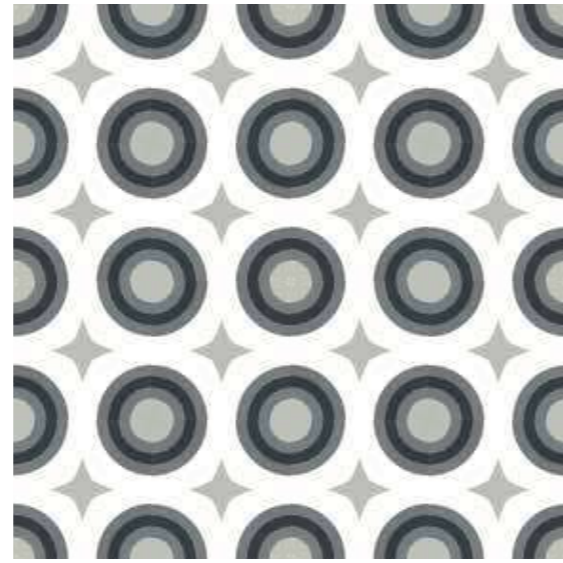

1 SOGGETTO - 1 PATTERN
(30pz per scatola - 30 pieces per box)

J87840
20,3x20,3 (8"x8")

night and day 03



1 SOGGETTO - 1 PATTERN
(30pz per scatola - 30 pieces per box)

J87841
20,3x20,3 (8"x8")

night and day 04



1 SOGGETTO - 1 PATTERN
(30pz per scatola - 30 pieces per box)

J87842
20,3x20,3 (8"x8")

night and day carpet

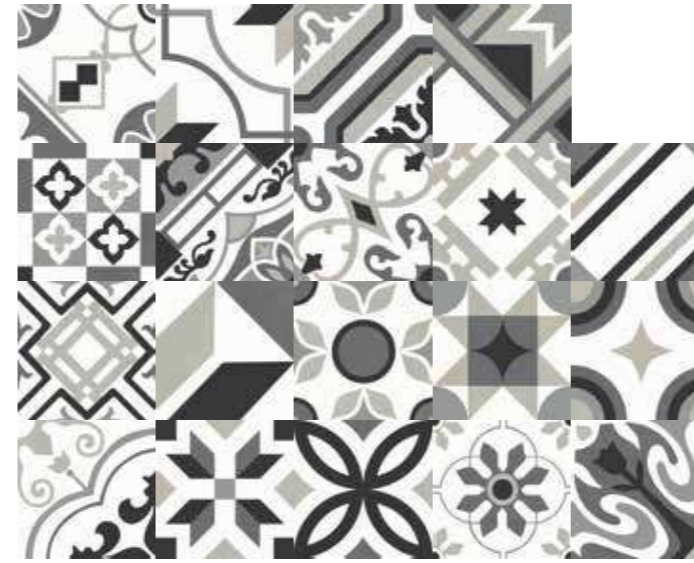

J87809
20,3x20,3 (8"x8")

19 SOGGETTI - 19 PATTERNS
(30pz random per scatola
30 random pieces per box)



ice

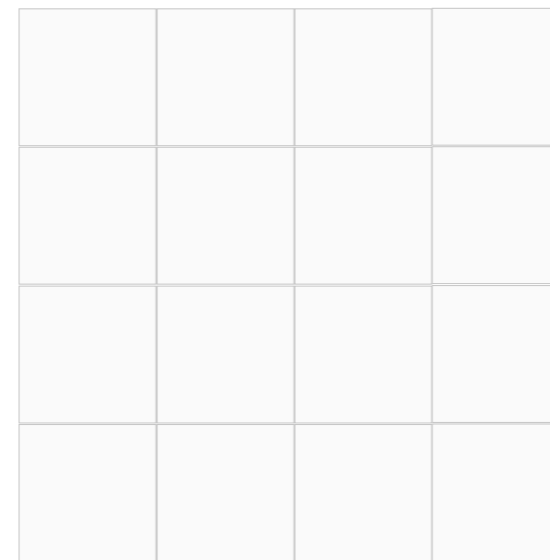

J87803
20,3x20,3 (8"x8")

beige multicolor 01



1 SOGGETTO - 1 PATTERN
(30pz per scatola - 30 pieces per box)

J87775
20,3x20,3 (8"x8")

beige multicolor 02

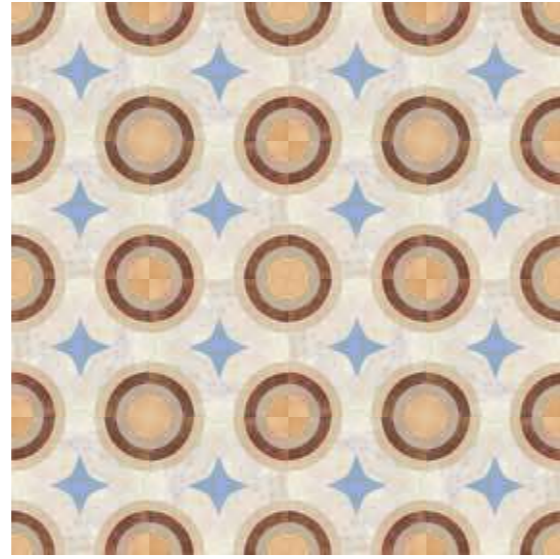

1 SOGGETTO - 1 PATTERN
(30pz per scatola - 30 pieces per box)

J87778
20,3x20,3 (8"x8")

beige multicolor mix



J87772
20,3x20,3 (8"x8")

19 SOGGETTI - 19 PATTERNS
(30pz random per scatola
30 random pieces per box)



beige multicolor 03



1 SOGGETTO - 1 PATTERN
(30pz per scatola - 30 pieces per box)

J87781
20,3x20,3 (8"x8")

beige multicolor 04



1 SOGGETTO - 1 PATTERN
(30pz per scatola - 30 pieces per box)

J87784
20,3x20,3 (8"x8")

almond



J87768
20,3x20,3 (8"x8")

grey sviluppo grafico 20,3x20,3 (8"x8")



63 20,3x20,3

GRAFICHE DIVERSE
DIFFERENT PATTERNS
DIFFÉRENTS MOTIFS
VERSCHIEDENE MUSTER

		20,3x20,3 (8"x8")
	BLUE 01	J87776
	BLUE 02	J87779
	BLUE 03	J87782
	BLUE 04	J87785
	BLUE MIX	J87773
	NIGHT&DAY 01	J87810
	NIGHT&DAY 02	J87840
	NIGHT&DAY 03	J87841
	NIGHT&DAY 04	J87842
	NIGHT&DAY CARPET	J87809
	BEIGE MULTICOLOR 01	J87775
	BEIGE MULTICOLOR 02	J87778
	BEIGE MULTICOLOR 03	J87781
	BEIGE MULTICOLOR 04	J87784
	BEIGE MULTICOLOR MIX	J87772
SPESSORE THICKNESS		9 mm
KG/M²		18,10
PZ/BOX		30
M²/BOX		1,24
BOX/PALLET		60
M²/PALLET		74,4
KG/PALLET		1347
€ <1 PALLET		59,40/m²
€ >1 PALLET		49,50/m²

		20,3x20,3 (8"x8")
	DARK	J87769
	GREY	J87770
	WHITE	J87771
	ICE	J87803
	ALMOND	J87768
SPESSORE THICKNESS		9 mm
KG/M²		18,10
PZ/BOX		30
M²/BOX		1,24
BOX/PALLET		60
M²/PALLET		74,4
KG/PALLET		1347
€ <1 PALLET		51,60/m²
€ >1 PALLET		43,00/m²

Contributo spese imballo € 10,00/pal (netto). - Packing charges € 10,00/pal (net)

0,13%
 A • HA • LA
 OK
 53,1 N/mm²
 6
 5
 4
 5
 R10 A
 MIX V4
 White, Grey, Almond, Dark V3
 Ice V1

Dark, Grey
 White, Grey, Almond, Dark
 Ice

Classe IV
 Classe V
 Dcof: Wet 0,45
 Pendulum: Dry 45 • Wet 26



floor
Tuscany - Capraia 40,6x40,6

[Back to Index](#)

TUSCANY

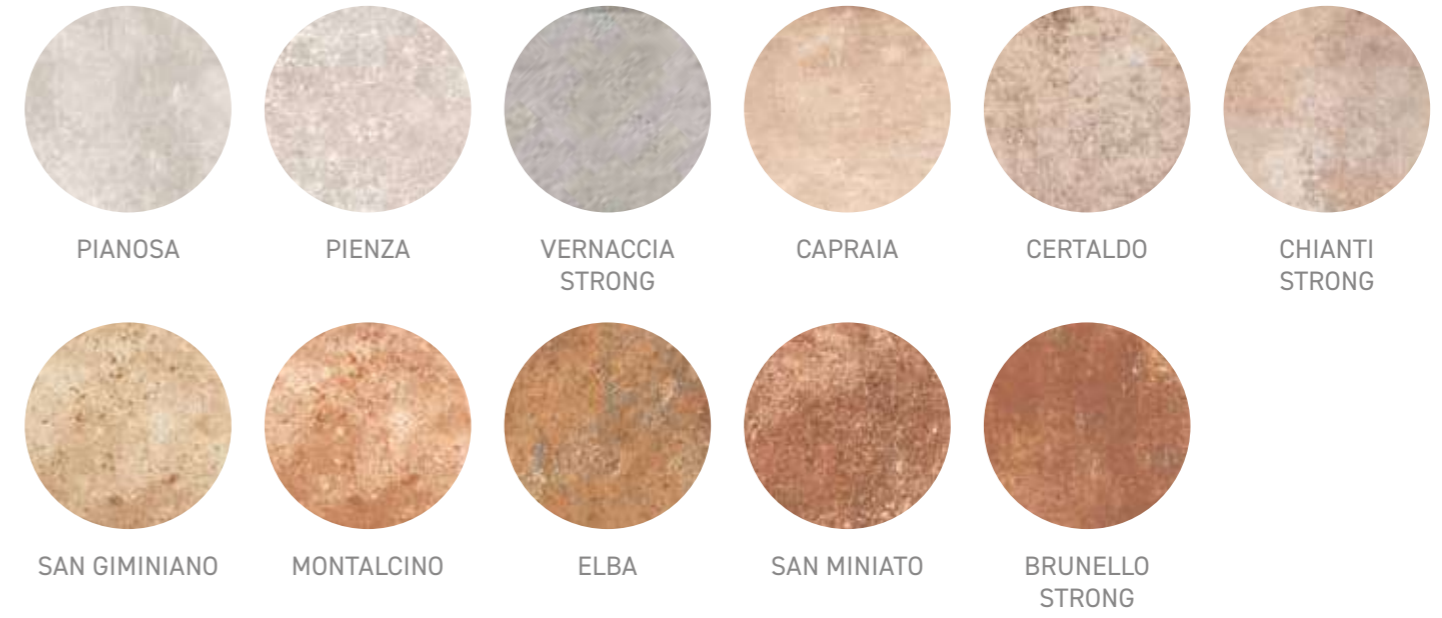

GRES PORCELLANATO A IMPASTO COLORATO
FULL BODY PORCELAIN STONEWARE
GRES CERAME A PATE COLOREE
DURCHGEFÄRBTES FEINSTEINZEUG

Certaldo, Pienza, Pianosa, Capraia, San Gimignano, Montalcino
San Miniato, Elba, Chianti Strong, Vernaccia Strong, Brunello Strong

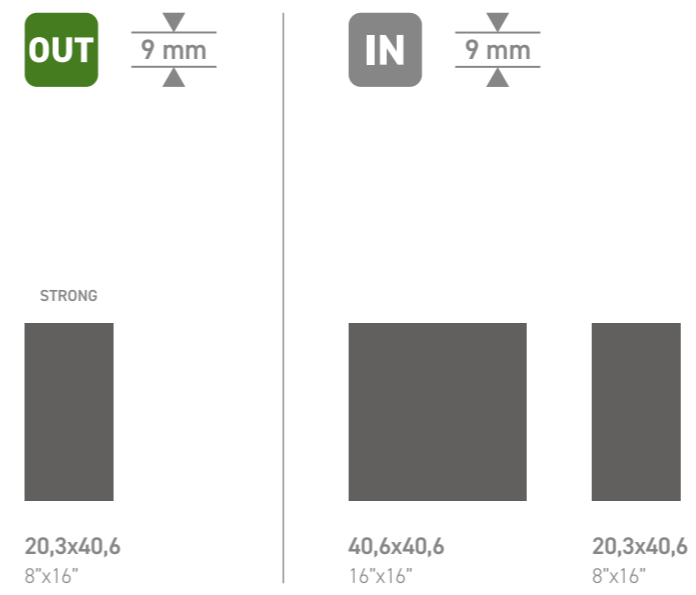

pienza

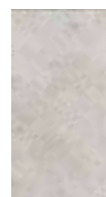

J87532
20,3x40,6 (8"x16")

pianosa

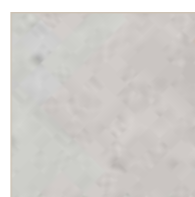

J88097
40,6x40,6 (16"x16")



vernaccia strong

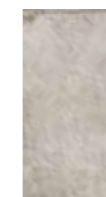

J87432
20,3x40,6 (8"x16")



certaldo



J87418
20,3x40,6 (8"x16")

capraia



J88095
40,6x40,6 (16"x16")

chianti strong



J87431
20,3x40,6 (8"x16")

san miniato



J87535
20,3x40,6 (8"x16")

elba



J88096
40,6x40,6 (16"x16")

brunello strong



J87430
20,3x40,6 (8"x16")

La stonalizzazione del colore Brunello Strong, permette di abbinarlo indifferentemente ai toni da interno San Miniato ed Elba

Thanks to its colour shading, Brunello Strong goes well with the interior tones of both San Miniato and Elba.

La « stonalizzazione » du coloris Brunello Strong permet de l'associer indifféremment aux tonalités pour l'intérieur San Miniato et Elba.

Die Farbabweichung der Farbe Brunello Strong erlaubt die Kombination mit den Innenfliesen San Miniato und Elba.

san gimignano



J87420
20,3x40,6 (8"x16")

montalcino



J87419
20,3x40,6 (8"x16")

brunello strong



J87430
20,3x40,6 (8"x16")

La stonizzazione del colore Brunello Strong, permette di abbinarlo indifferentemente ai toni da interno San Gimignano e Montalcino

Thanks to its colour shading, Brunello Strong goes well with the interior tones of both San Gimignano and Montalcino

La « stonizzazione » du coloris Brunello Strong permet de l'associer indifféremment aux tonalités pour l'intérieur San Gimignano et Montalcino.

Die Farbabweichung der Farbe Brunello Strong erlaubt die Kombination mit den Innenfliesen San Gimignano und Montalcino.

decoro giotto mix

19 soggetti - 19 patterns (30pz random per scatola - 30 random pieces per box)



J87743
20,3x20,3 (8"x8")

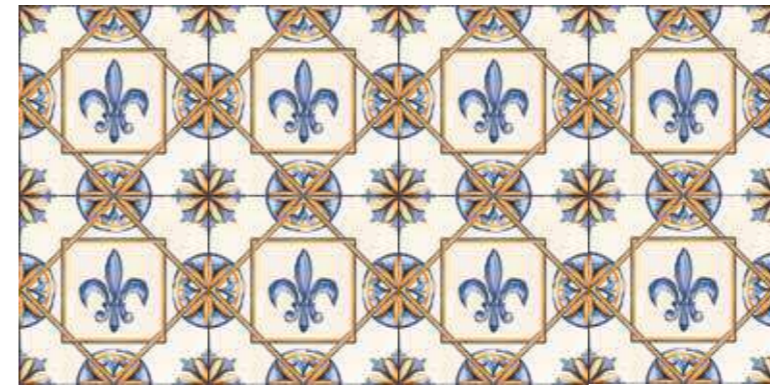

decoro giotto 1
(30pz per scatola - 30 pieces per box)



J87856
20,3x20,3 (8"x8")



decoro giotto 2
(30pz per scatola - 30 pieces per box)



J87857
20,3x20,3 (8"x8")

san gimignano sviluppo grafico 20,3x40,6 (8"x16")



75 20,3x40,6

GRAFICHE DIVERSE
DIFFERENT PATTERNS
DIFFÉRENTS MOTIFS
VERSCHIEDENE MUSTER

32 40,6x40,6

GRAFICHE DIVERSE
DIFFERENT PATTERNS
DIFFÉRENTS MOTIFS
VERSCHIEDENE MUSTER

Data la struttura irregolare dei bordi della tavola, che richiama la manifattura artigianale del classico cotto fiorentino, per esaltare le qualità estetiche del prodotto, si consiglia una fuga minima di 4 mm.

Given the irregular structure of the edges of the tile, which recalls the traditional craftsmanship of the Florentine "Cotto", to enhance its aesthetic qualities, we recommend a minimum joint of 4 mm.

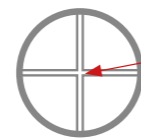

POSARE CON FUGA DI 4 MM
LAY WITH 4 MM JOINT
POSER AVEC UN JOINT DE 4 MM
MIT EINER 4 MM FUGE VERLEGEN

0,1%
 A · HA · LA
 OK
 51,4N/mm²
 5
 5
 Classe IV
 Classe V
 Dcof: Wet 0,42 Pendulum: Dry 56 · Wet 25
 Dcof: Wet 0,70 Pendulum: Dry 54 · Wet 26
 Certaldo, Pienza, Pianosa, Capraia, San Gimignano, Montalcino
 San Miniato, Elba, Chianti Strong, Vernaccia Strong, Brunello Strong

	40,6x40,6 (16"x16")	20,3x40,6 (8"x16")	Decoro Giotto Mix 20,3x20,3 (8"x8")	Decoro Giotto 1 20,3x20,3 (8"x8")	Decoro Giotto 2 20,3x20,3 (8"x8")
PIENZA	-	J87532	J87743	J87856	J87857
CERTALDO	-	J87418	J87743	J87856	J87857
SAN GIMINIANO	-	J87420	J87743	J87856	J87857
SAN MINIATO	-	J87535	J87743	J87856	J87857
MONTALCINO	-	J87419	J87743	J87856	J87857
CAPRAIA	J88095	-	J87743	J87856	J87857
ELBA	J88096	-	J87743	J87856	J87857
PIANOSA	J88097	-	J87743	J87856	J87857
VERNACCIA STR.	-	J87432	J87743	J87856	J87857
CHIANTI STRONG	-	J87431	J87743	J87856	J87857
BRUNELLO STR.	-	J87430	J87743	J87856	J87857
SPESORE THICKNESS	9 mm	9 mm	9 mm	9 mm	9 mm
KG/M ²	17,37	19	18,10	18,10	18,10
PZ/BOX	6	13	30	30	30
M ² /BOX	0,99	1,07	1,24	1,24	1,24
BOX/PALLET	72	72	60	60	60
M ² /PALLET	71,28	77,04	74,4	74,4	74,4
KG/PALLET	1238,4	1463,8	1347	1347	1347
€ <1 PALLET	39,60/m ²	39,60/m ²	59,40/m ²	59,40/m ²	59,40/m ²
€ >1 PALLET	33,00/m ²	33,00/m ²	49,50/m ²	49,50/m ²	49,50/m ²

	Battiscopa 8x45 (3 1/2"x18")	Gradino+Toro 20,3x40,6x5,5 (8"x16"x2")	Angolo+Toro Dx 20,3x40,6x5,5 (8"x16"x2")	Angolo+Toro Sx 20,3x40,6x5,5 (8"x16"x2")	Elemento a L monol. STRONG 40,6x10x5 (16"x4"x2")
PIENZA	J87423	J87730	J87735	J87740	-
CERTALDO	J87421	J87728	J87733	J87738	-
SAN GIMINIANO	J87533	J87731	J87736	J87741	-
SAN MINIATO	J87536	J87732	J87737	J87742	-
MONTALCINO	J87422	J87729	J87734	J87739	-
CHIANTI STRONG	-	-	-	-	J87428
VERNACCIA STR.	-	-	-	-	J87429
BRUNELLO STR.	-	-	-	-	J87427
PZ/BOX	30	6	2	2	8
€/UM	5,40/ml	28,50 pz/pce	58,50 pz/pce	58,50 pz/pce	23,00 pz/pce

Contributo spese imballo € 10,00/pal (netto). - Packing charges € 10,00/pal (net)

VOLCANO

[Back to Index](#)



DARK

GREY

WHITE

BEIGE

TAUPE



Coordinato con:
Coordinated with:
VOLCANO 3D
SEZ. 3D
PG. 157

GRES PORCELLANATO A IMPASTO COLORATO
FULL BODY PORCELAIN STONEWARE
GRES CERAME A PATE COLOREE
DURCHGEFÄRBTES FEINSTEINZEUG



100x100 rett.
39 1/4"x39 1/4" rect.



80x80 rett.
31 1/2"x31 1/2" rect.



60x60 rett.
24"x24" rect.



100x100 rett.
39 1/4"x39 1/4" rect.



60x120 rett.
24"x48" rect.



80x80 rett.
31 1/2"x31 1/2" rect.



60x60 rett.
24"x24" rect.



30x60 rett.
12"x24" rect.



30,5x60,5
12"x24"

MODULO
MODULE



30x60 rett. (12"x24") rect.
15x60/10x60/5x60

floor
Volcano - White 100x100

dark



J87610
60x120 rett. (24"x48") rett.



J88997
100x100 rett. (39 1/4"x39 1/4") rett.



J86848
80x80 rett. (31 1/2"x31 1/2") rett.



J86850
60x60 rett. (24"x24") rett.



J86852
30x60 rett. (12"x24") rett.



J86851
30,5x60,5 (12"x24")



J86790 Modulo
30x60 rett. (12"x24") rett.
15x60/10x60/5x60



J86794
30x30 (12"x12")



h20



J89007
100x100 rett. (39 1/4"x39 1/4") rett.

h20



J87394
80x80 rett. (31 1/2"x31 1/2") rett.

h20



J87497
60x60 rett. (24"x24") rett.

Disponibili pezzi speciali H20 a pag. 681-682-683

grey

IN R10 B



J87611
60x120 rett. (24"x48") rett.



J88998
100x100 rett. (39 1/4"x39 1/4") rett.



J86686
80x80 rett. (31 1/2"x31 1/2") rett.



J86682
60x60 rett. (24"x24") rett.



J86694
30x60 rett. (12"x24") rett.



J86690
30,5x60,5 (12"x24")

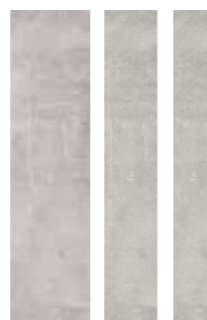

J86791 Modulo
30x60 rett. (12"x24") rett.
15x60/10x60/5x60



J86722
30x30 (12"x12")

OUT R11 C

h20



J89008
100x100 rett. (39 1/4"x39 1/4") rett.

h20



J87395
80x80 rett. (31 1/2"x31 1/2") rett.

h20



J87498
60x60 rett. (24"x24") rett.

Disponibili pezzi speciali H20 a pag. 681-682-683

white



J87613
60x120 rett. (24"x48") rett.



J89000
100x100 rett. (39 1/4"x39 1/4") rett.



J86688
80x80 rett. (31 1/2"x31 1/2") rett.



J86684
60x60 rett. (24"x24") rett.

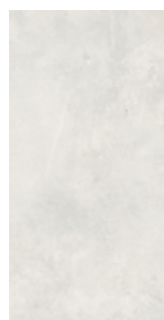

J86696
30x60 rett. (12"x24") rett.

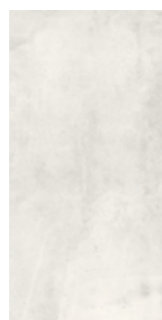

J86692
30,5x60,5 (12"x24")



J86793 Modulo
30x60 rett. (12"x24") rett.
15x60/10x60/5x60



J86724
30x30 (12"x12")



h20



J89010
100x100 rett. (39 1/4"x39 1/4") rett.

h20



J87397
80x80 rett. (31 1/2"x31 1/2") rett.

h20



J87500
60x60 rett. (24"x24") rett.

Disponibili pezzi speciali H20 a pag. 681-682-683

beige



J87609
60x120 rett. (24"x48") rect.



J88996
100x100 rett. (39 1/4"x39 1/4") rect.



J86685
80x80 rett. (31 1/2"x31 1/2") rect.



J86681
60x60 rett. (24"x24") rect.



J86693
30x60 rett. (12"x24") rect.



J86689
30,5x60,5 (12"x24")



J86789 Modulo
30x60 rett. (12"x24") rect.
15x60/10x60/5x60



J86721
30x30 (12"x12")



h20



J89006
100x100 rett. (39 1/4"x39 1/4") rect.

h20



J87393
80x80 rett. (31 1/2"x31 1/2") rect.

h20



J87496
60x60 rett. (24"x24") rect.

Disponibili pezzi speciali H20 a pag. 681-682-683

taupe



J87612
60x120 rett. (24"x48") rett.



J88999
100x100 rett. (39 1/4"x39 1/4") rett.



J86687
80x80 rett. (31 1/2"x31 1/2") rett.



J86683
60x60 rett. (24"x24") rett.



J86695
30x60 rett. (12"x24") rett.



J86691
30,5x60,5 (12"x24")



J86792 Modulo
30x60 rett. (12"x24") rett.
15x60/10x60/5x60

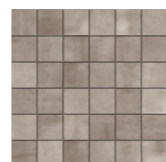

J86723
30x30 (12"x12")



h20



J89009
100x100 rett. (39 1/4"x39 1/4") rett.

h20



J87396
80x80 rett. (31 1/2"x31 1/2") rett.

h20



J87499
60x60 rett. (24"x24") rett.

Disponibili pezzi speciali H20 a pag. 681-682-683

VOLCANO

IN R10
B

cementine grey 3 pz random per scatola - 3 random pieces per box



J86796 GRAFFITI MIX WHITE
30x60 rett. (12"x24") rect.



J86828
60x60 rett. (24"x24") rect.

cementine beige 3 pz random per scatola - 3 random pieces per box



J86795 GRAFFITI MIX BEIGE
30x60 rett. (12"x24") rect.



J86829
60x60 rett. (24"x24") rect.



wall
Volcano - Cementine Grey 60x60

floor
Volcano - White 80x80

grey sviluppo grafico 60x60 rett. (24"x24") rect.



12 100x100

GRAFICHE DIVERSE
DIFFERENT PATTERNS
DIFFÉRENTS MOTIFS
VERSCHIEDENE MUSTER

12 80x80

GRAFICHE DIVERSE
DIFFERENT PATTERNS
DIFFÉRENTS MOTIFS
VERSCHIEDENE MUSTER

14 60x120

GRAFICHE DIVERSE
DIFFERENT PATTERNS
DIFFÉRENTS MOTIFS
VERSCHIEDENE MUSTER

28 60x60

GRAFICHE DIVERSE
DIFFERENT PATTERNS
DIFFÉRENTS MOTIFS
VERSCHIEDENE MUSTER

56 30x60

GRAFICHE DIVERSE
DIFFERENT PATTERNS
DIFFÉRENTS MOTIFS
VERSCHIEDENE MUSTER

	100x100 rett. (39 1/2"x39 1/2") rect.	60x120 rett. (24"x48") rect.	80x80 rett. (31 1/2"x31 1/2") rect.	60x60 rett. (24"x24") rect.	30x60 rett. (12"x24") rect.	30,5x60,5 (12"x24")	Modulo 30x60 rett. (12"x24") rect.	h20 100x100 rett. (39 1/2"x39 1/2") rect.	h20 80x80 rett. (31 1/2"x31 1/2") rect.	h20 60x60 rett. (24"x24") rect.
DARK	J88997	J87610	J86848	J86850	J86852	J86851	J86790	J89007	J87394	J87497
GREY	J88998	J87611	J86686	J86682	J86694	J86690	J86791	J89008	J87395	J87498
WHITE	J89000	J87613	J86688	J86684	J86696	J86692	J86793	J89010	J87397	J87500
BEIGE	J88996	J87609	J86685	J86681	J86693	J86689	J86789	J89006	J87393	J87496
TAUPE	J88999	J87612	J86687	J86683	J86695	J86691	J86792	J89009	J87396	J87499
SPESSORE THICKNESS	8,5 mm	9,5 mm	9,5 mm	9,5 mm	9,5 mm	9,5 mm	9,5 mm	20 mm	20 mm	20 mm
KG/M²	20,00	21,81	21,21	21,46	19,13	18,98	19,44	40,00	47,65	44,4
PZ/BOX	2	2	2	3	6	6	5	1	1	2
M²/BOX	2,00	1,44	1,28	1,08	1,08	1,11	0,9	1,00	0,64	0,72
BOX/PALLET	24	32	40	40	48	48	40	24	40	32
M²/PALLET	48,00	46,08	51,20	43,20	51,84	53,28	36,00	24,00	25,6	23,04
KG/PALLET	960	1005,12	1086	927,2	992,16	1011,36	700	960	1219,84	1024
€ <1 PALLET	69,00/m²	65,00/m²	65,00/m²	54,00/m²	46,10/m²	42,00/m²	90,90/m²	110,40/m²	107,00/m²	80,00/m²
€ >1 PALLET	60,00/m²	56,50/m²	56,50/m²	45,00/m²	38,40/m²	35,00/m²	79,00/m²	96,00/m²	93,00/m²	69,50/m²

	Cementine Grey 60x60 rett. (24"x24") rect.	Cementine Beige 60x60 rett. (24"x24") rect.	Graffiti Mix White 30x60 rett. (12"x24") rect.	Graffiti Mix Beige 30x60 rett. (12"x24") rect.	Mosaico 30x30 (12"x12")	Battiscopa 7,5x60 rett. (3"x24") rect.	Gradino 40x80 rett. (16"x31 1/2") rect.	Gradino 30x60 rett. (12"x24") rect.
DARK	J86828	-	J86796	-	J86794	J86856	J87472	J87502
GREY	J86828	-	J86796	-	J86722	J86857	J87473	J87503
WHITE	J86828	-	J86796	-	J86724	J86859	J87475	J87505
BEIGE	-	J86829	-	J86795	J86721	J86855	J87471	J87501
TAUPE	-	J86829	-	J86795	J86723	J86858	J87474	J87504
PZ/BOX	3	3	4	4	6	12	2	1
€ <1 PALLET	63,30/m²	63,30/m²	47,20 pz/pce	47,20 pz/pce	122,20 m²	9,30 pz/pce	109,00 pz/pce	76,70 pz/pce
€ >1 PALLET	55,00/m²	55,00/m²	47,20 pz/pce	47,20 pz/pce	122,20 m²	9,30 pz/pce	109,00 pz/pce	76,70 pz/pce

0,05% A • HA • LA OK >50 N/mm² 7 5 Classe IV Classe V R10 B R11 C V3

Dark White, Taupe, Beige, Grey h20

Dcof: Wet 0,42 Pendulum: Dry 43 • Wet 27 Dcof: Wet 0,42 Pendulum: Dry 63 • Wet 59

Contributo spese imballo € 10,00/pal (netto). - Packing charges € 10,00/pal (net)

Contributo spese imballo € 20,00/pal (netto) per formato 100x100 sp. 8,5 mm - Packing charges € 20,00/pal (net) for size 100x100 th. 8,5 mm

COLLEZIONI METROPOLITANE

Cobblewood	640	Jungle	647
Decking	642	Visual	653
Doghe	644		

// Le Collezioni Metropolitane offrono un ricco ventaglio di opportunità per scegliere il materiale che più di tutti sia in grado di comunicare un preciso stile di design e dare personalità ad ogni ambiente.

Ispirazioni diverse per dare voce creativa alle esigenze del progettista alla ricerca della soluzione più adatta per l'interno e l'outdoor.

//

The Metropolitane collections offer a wide range of opportunities to choose material which better than any other can communicate a clear design style and add personality to any room. Different inspirations add a creative touch to needs of designers looking for the most suitable solutions, indoors and out.

Les collections Métropolitaines offrent un riche éventail d'opportunités pour choisir le matériau qui, mieux que tous les autres, est en mesure de communiquer un style précis de design et de conférer un caractère à chaque environnement. Des inspirations différentes pour que les exigences créatives du concepteur puissent s'exprimer, à la recherche de la solution la plus adaptée pour l'intérieur et l'extérieur.

Die Kollektionen Metropolitane enthalten ein vielfächertes Angebot an Material, das vortrefflich einen präzisen Stil von Design zum Ausdruck bringt und es ermöglicht, jeden Raum nach persönlichem Geschmack einzurichten. Die verschiedensten Inspirationen für eine kreative Planung und eine maßgeschneiderte Lösung für Innen- und Außenbereiche.)



GREY

BEIGE



GRES PORCELLANATO SMALTATO
GLAZED PORCELAIN STONWARE
GRES CERAME EMAILLE
GLASIERTESFEINSTEINZEUG

8,5 mm



34x34
13 1/2"x13 1/2"



floor
Cobblewood - Beige 34x34



grey







J84592
34x34 (13 1/2"x13 1/2")

beige

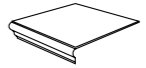
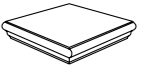

J84591
34x34 (13 1/2"x13 1/2")

	 34x34 (13 1/2"x13 1/2")	 Battiscopa 8x34 (3 1/4"x13 1/2")	 Gradino+Toro 34x34 (13 1/2"x13 1/2")	 Gradino+Toro 34x34 (13 1/2"x13 1/2")
 GREY	J84592	J84594	J84606	J84608
 BEIGE	J84591	J84593	J84605	J84607
SPESSORE THICKNESS	8,5 mm	-	-	-
KG/M²	16,71	-	-	-
PZ/BOX	11	12	6	2
M²/BOX	1,27	-	-	-
BOX/PALLET	48	-	-	-
M²/PALLET	60,96	-	-	-
KG/PALLET	1018,8	-	-	-
€ <1 PALLET	30,00 m²	4,5 pz/pce	27,50 pz/pce	53,50 pz/pce
€ >1 PALLET	25,00 m²	4,5 pz/pce	27,50 pz/pce	53,50 pz/pce

Contributo spese imballo € 10,00/pal (netto). - Packing charges € 10,00/pal (net)



0,1% A-HA-LA OK 43 N/mm² 8 5 Classe V R10 B V2

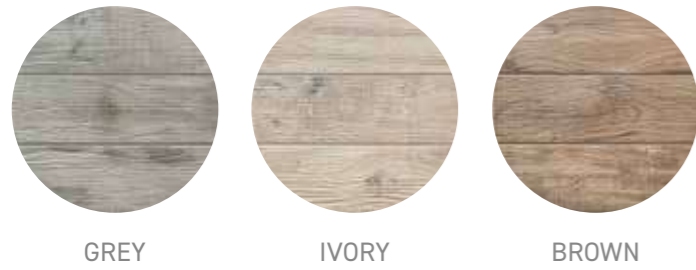

GREY

IVORY

BROWN



GRES PORCELLANATO SMALTATO
GLAZED PORCELAIN STONEWARE
GRES CERAME EMAILLE
GLASIERTESFEINSTEINZEUG

8,5 mm



34x34
13 1/2"x13 1/2"



floor
Decking - Grey 34x34



grey



J85374
34x34 (13 1/2"x13 1/2")

ivory



J85375
34x34 (13 1/2"x13 1/2")

brown



J85373
34x34 (13 1/2"x13 1/2")

		A SP	B SP	A SP	B SP	A SP	B SP	
	34x34 (13 1/2"x13 1/2")	Battiscopa 11x34 (4 3/8"x13 1/2")	Gradino+Toro 34x34 (13 1/2"x13 1/2")	Gradino+Toro 34x34 (13 1/2"x13 1/2")	Angolo+Toro 34x34 (13 1/2"x13 1/2")	Angolo+Toro 34x34 (13 1/2"x13 1/2")	Elem. a L incollato 34x34x11 (13 1/2"x13 1/2"x 4 3/8")	Elem. a L incollato 34x34x11 (13 1/2"x 3 1/2"x 4 3/8")
GREY	J85374	J85395	J85377	J85383	J85380	J85386	J85389	J85392
IVORY	J85375	J85396	J85378	J85384	J85381	J85387	J85390	J85393
BROWN	J85373	J85394	J85376	J85382	J85379	J85385	J85388	J85391
SPESSORE THICKNESS	8,5 mm	-	-	-	-	-	-	-
KG/M²	16,8	-	-	-	-	-	-	-
PZ/BOX	11	12	6	6	2	2	8	8
M²/BOX	1,27	-	-	-	-	-	-	-
BOX/PALLET	48	-	-	-	-	-	-	-
M²/PALLET	60,96	-	-	-	-	-	-	-
KG/PALLET	1027,2	-	-	-	-	-	-	-
€ <1 PALLET	30,00/m²	4,50 pz/pce	27,50 pz/pce	27,50 pz/pce	53,50 pz/pce	53,50 pz/pce	14,40 pz/pce	14,40 pz/pce
€ >1 PALLET	25,00/m²	4,50 pz/pce	27,50 pz/pce	27,50 pz/pce	53,50 pz/pce	53,50 pz/pce	14,40 pz/pce	14,40 pz/pce

Contributo spese imballo € 10,00/pal (netto). - Packing charges € 10,00/pal (net)



0,08%

A • HA • LA

OK

35,1 N/mm²

8

5

Classe IV

Dcof: Wet 0,52
Pendulum:
Dry 49 • Wet 42

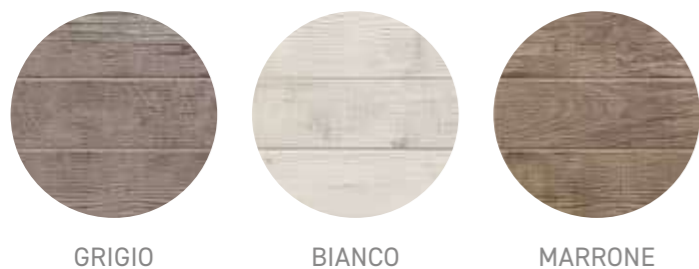

GRIGIO BIANCO MARRONE



GRES PORCELLANATO SMALTATO
GLAZED PORCELAIN STONWARE
GRES CERAME EMAILLE
GLASIERTESFEINSTEINZEUG

8,5 mm



34x34
13 1/2"x13 1/2"



floor
Doghe - Grigio 34x34



grigio



J86176
34x34 (13 1/2"x13 1/2")

bianco



J86175
34x34 (13 1/2"x13 1/2")

marrone



J86177
34x34 (13 1/2"x13 1/2")

		A SP	B SP	A SP	B SP	A SP	B SP	
	34x34 (13 1/2"x13 1/2")	11x34 (4 3/8"x13 1/2")	34x34 (13 1/2"x13 1/2")	34x34 (13 1/2"x13 1/2")	34x34 (13 1/2"x13 1/2")	34x34 (13 1/2"x13 1/2")	34x34x11 (13 1/2"x13 1/2"x 4 3/8")	34x34x11 (13 1/2"x13 1/2"x 4 3/8")
GRIGIO	J86176	J86233	J86236	J86239	J86242	J86245	J86248	J86251
BIANCO	J86175	J86232	J86235	J86238	J86241	J86244	J86247	J86250
MARRONE	J86177	J86234	J86237	J86240	J86243	J86246	J86249	J86252
SPESSORE THICKNESS	8,5 mm	-	-	-	-	-	-	-
KG/M²	15,98	-	-	-	-	-	-	-
PZ/BOX	11	12	6	6	2	2	8	8
M²/BOX	1,27	-	-	-	-	-	-	-
BOX/PALLET	48	-	-	-	-	-	-	-
M²/PALLET	60,96	-	-	-	-	-	-	-
KG/PALLET	974,4	-	-	-	-	-	-	-
€ < 1 PALLET	30,00/m²	4,50 pz/pce	27,50 pz/pce	27,50 pz/pce	53,50 pz/pce	53,50 pz/pce	14,40 pz/pce	14,40 pz/pce
€ > 1 PALLET	25,00/m²	4,50 pz/pce	27,50 pz/pce	27,50 pz/pce	53,50 pz/pce	53,50 pz/pce	14,40 pz/pce	14,40 pz/pce

Contributo spese imballo € 10,00/pal (netto). - Packing charges € 10,00/pal (net)



0,08% A · HA · LA OK 35,1 N/mm² 8 5 Classe V R11 C Dcof: Wet 0,52 Pendulum: Dry 49 · Wet 42



floor
Jungle - Light Grey 15x61
Jungle - Mud 15x61

[Back to Index](#)

JUNGLE



BLACK



MUD



LIGHT GREY

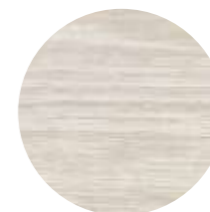

WHITE



CAPUCINO

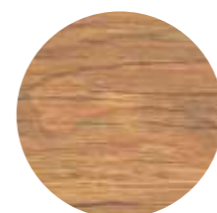

HONEY



BROWN



GRES PORCELLANATO SMALTATO
GLAZED PORCELAIN STONWARE
GRES CERAME EMAILLE
GLASIERTESFEINSTEINZEUG



9 mm

15x61 DA PRESSA
6"x24" MOULDED



15x61
6"x24"



black



S54340
15x61 (6"x24")

mud



S54045
15x61 (6"x24")

light grey



S54044
15x61 (6"x24")

white



S54046
15x61 (6"x24")



S54172 Mosaico Lux Grey
30,5x30,5 (12"x12")

capucino



S54042
15x61 (6"x24")

honey



S54043
15x61 (6"x24")

brown



S54041
15x61 (6"x24")



S54170 Brown Stamp Mix
15x61 (6"x24")



S54171 Mosaico Lux Beige
30,5x30,5 (12"x12")

DECORO STAMP MIX 15x61 (6"x24")
DISPONIBILE ANCHE NEI SEGUENTI COLORI
ALSO AVAILABLE IN THE FOLLOWING COLORS



















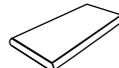
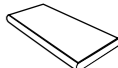

S54165 Capucino Stamp Mix
S54169 Honey Stamp Mix
S54168 Light Grey Stamp Mix

S54167 Mud Stamp Mix
S54166 White Stamp Mix

JUNGLE



floor
Jungle - Brown 15x61

				
	15x61 (6"x24")	Stamp Mix 15x61 (6"x24")	Mosaico Lux Beige 30,5x30,5 (12"x12")	Mosaico Lux Grey 30,5x30,5 (12"x12")
 BLACK	S54340	-	-	S54172
 MUD	S54045	S54167	-	S54172
 LIGHT GREY	S54044	S54168	-	S54172
 WHITE	S54046	S54166	-	S54172
 CAPUCINO	S54042	S54165	S54171	-
 HONEY	S54043	S54169	S54171	-
 BROWN	S54041	S54170	S54171	-
SPESSORE THICKNESS	9 mm	9 mm	9 mm	9 mm
KG/M²	17,41	17,41	19,28	19,28
PZ/BOX	13	4	6	6
M²/BOX	1,2	-	0,56	0,56
BOX/PALLET	48	-	60	60
M²/PALLET	57,6	-	33,60	33,60
KG/PALLET	1003,2	-	648	648
€ <1 PALLET	39,60/m²	13,60 pz/pce	28,70 pz/pce	28,70 pz/pce
€ >1 PALLET	33,00/m²	13,60 pz/pce	28,70 pz/pce	28,70 pz/pce
				
	Battiscopa 8x45 (3 1/4"x18")	Gradino+Toro 15x30 (6"x12")	Angolo+Toro Dx 15x30 (6"x12")	Angolo+Toro Sx 15x30 (6"x12")
 BLACK	S54341	-	-	-
 MUD	S54065	S54071	S54077	S54083
 LIGHT GREY	S54064	S54070	S54076	S54082
 WHITE	S54066	S54072	S54078	S54084
 CAPUCINO	S54062	S54068	S54074	S54080
 HONEY	S54063	S54069	S54075	S54081
 BROWN	S54061	S54067	S54073	S54079
PZ/BOX	30	8	2	2
€/UM	5,40/ml	21,40 pz/pce	52,00 pz/pce	52,00 pz/pce

Contributo spese imballo € 10,00/pal (netto). - Packing charges € 10,00/pal (net)

								
0,1%	A · HA · LA	OK	52,5 N/mm²	8	5	Classe V	R10 A	V2



wall
Visual - Mosaico Panna 30x30

floor
Visual - Sabbia 15x61

[Back to Index](#)

VISUAL



FUMO



SABBIA



PANNA



NATURALE



MIELE



MORO



GRES PORCELLANATO SMALTATO
GLAZED PORCELAIN STONEWARE
GRES CERAME EMAILLE
GLASIERTESFEINSTEINZEUG



9 mm

15x61 DA PRESSA
6"x24" MOULDED



15x61
6"x24"



fumo



J85200
15x61 (6"x24")

sabbia



J85204
15x61 (6"x24")

panna



J85203
15x61 (6"x24")

naturale



J85294
15x61 (6"x24")

miele



J85201
15x61 (6"x24")

moro



J85202
15x61 (6"x24")



J85461 Mosaico Panna
30x30 (12"x12")



J85462 Mosaico Miele
30x30 (12"x12")

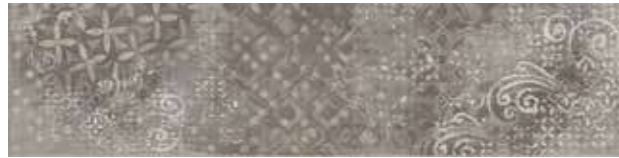

J85259 Classic Panna
15x61 (6"x24")



J85260 Classic Sabbia
15x61 (6"x24")



J85261 Brio
15x61 (6"x24")



J85262 Vivace
15x61 (6"x24")



floor
Visual - Panna 15x61
Visual - Classic Panna 15x61

	15x61 (6"x24")	Classic Sabbia 15x61 (6"x24")	Classic Panna 15x61 (6"x24")	Brio 15x61 (6"x24")	Vivace 15x61 (6"x24")	Mosaico Panna 30x30 (12"x12")	Mosaico Miele 30x30 (12"x12")
FUMO	J85200	J85260	J85259	J85261	J85262	J85461	-
SABBIA	J85204	J85260	J85259	J85261	J85262	J85461	-
PANNA	J85203	J85260	J85259	J85261	J85262	J85461	-
NATURALE	J85294	J85260	J85259	J85261	J85262	-	J85462
MIELE	J85201	J85260	J85259	J85261	J85262	-	J85462
MORO	J85202	J85260	J85259	J85261	J85262	-	J85462
SPESORE THICKNESS	9 mm	9 mm	9 mm	9 mm	9 mm	9 mm	9 mm
KG/M²	17,52	17,52	17,52	17,52	17,52	17,52	17,52
PZ/BOX	13	4	4	4	4	6	6
M²/BOX	1,2	-	-	-	-	-	-
BOX/PALLET	48	-	-	-	-	-	-
M²/PALLET	57,6	-	-	-	-	-	-
KG/PALLET	1009,4	-	-	-	-	-	-
€ <1 PALLET	39,60/m²	20,00 pz/pce	20,00 pz/pce	23,00 pz/pce	23,00 pz/pce	170,00/m²	170,00/m²
€ >1 PALLET	33,00/m²	20,00 pz/pce	20,00 pz/pce	23,00 pz/pce	23,00 pz/pce	170,00/m²	170,00/m²

	Battiscopa 8x45 (3 1/4"x18")	Gradino+Toro 15x30 (6"x12")	Angolo+Toro Dx 15x30 (6"x12")	Angolo+Toro Sx 15x30 (6"x12")
FUMO	J85205	J85463	J85469	J85475
SABBIA	J85209	J85468	J85474	J85480
PANNA	J85208	J85467	J85473	J85479
NATURALE	J85295	J85466	J85472	J85478
MIELE	J85206	J85464	J85470	J85476
MORO	J85207	J85465	J85471	J85477
PZ/BOX	30	8	2	2
€/UM	5,40/ml	21,40 pz/pce	52,00 pz/pce	52,00 pz/pce

Contributo spese imballo € 10,00/pal (netto). - Packing charges € 10,00/pal (net)

Moro

0,1%	A · HA · LA	OK	44,4 N/mm²	6	5	Classe IV	Classe V	Dcof: Wet 0,56 Pendulum: Dry 59 · Wet 28	

BATTISCOPA

BATTISCOPA 8x33,3 - 3¼"x13"

ARDESIA	661
BG	661
BIANCO	661
BR	662
CM	663
MO	663
NERO	664
TC	664
VINTAGE	665

BATTISCOPA 8x45 - 3¼"x18"

BL	666
CT	667
DR	668
EV	669
GW	670
HS	671
JU	672
LC	673
OT	673
QR	674
TA	674
TIMELESS	675
TS	675
VN	676
VS	676
WD	677



GRES PORCELLANATO

Porcelain Stoneware
Gres Cerame Fin
Feinsteinzeug

ARDESIA

ardesia

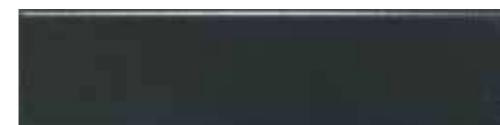

S52634

BG

BG 314



S52664

BG 311



S52661

BG 313



S52663

BIANCO

300 L

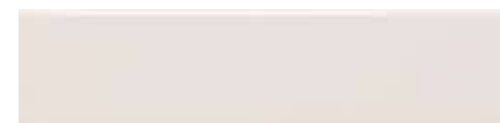

S52540

300 M

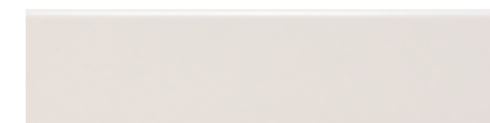

S52545

IMBALLI . PACKING . EMBALLAGE . VERPACKUNG .

FORMATO - SIZE	PZ/BOX	ML/BOX	KG/ML	BOX/PALLET	ML/PALLET	KG/PALLET	EURO < 1 PALLET	EURO ≥1 PALLET
Battiscopa 8x33,3 (3 1/4"x13")	27	9	1,25	66	594	742,50	4,80 ml/m	

Contributo spese imballo € 10,00/pal (netto). - Packing charges € 10,00/pal (net)

BR

br cream



J85549

br rust



J85552

br red



J85551

br umber



J85553

br dark



J85550

IMBALLI . PACKING . EMBALLAGE . VERPACKUNG .

FORMATO - SIZE	PZ/BOX	ML/BOX	KG/ML	BOX/PALLET	ML/PALLET	KG/PALLET	EURO < 1 PALLET	EURO ≥1 PALLET
Battiscopa 8x33,3 (3 1/4"x13")	27	9	1,25	66	594	742,50	4,80 ml/m	

Contributo spese imballo € 10,00/pal (netto). - Packing charges € 10,00/pal (net)

CM

cm 71



S52678

cm 76



S52686

cm 73



S52683

cm 75



S52685

MO

mo 1



S52926

mo 2



S52927

mo 3



S52928

mo 4



S52929

IMBALLI . PACKING . EMBALLAGE . VERPACKUNG .

FORMATO - SIZE	PZ/BOX	ML/BOX	KG/ML	BOX/PALLET	ML/PALLET	KG/PALLET	EURO < 1 PALLET	EURO ≥1 PALLET
Battiscopa 8x33,3 (3 1/4"x13")	27	9	1,25	66	594	742,50	4,80 ml/m	

Contributo spese imballo € 10,00/pal (netto). - Packing charges € 10,00/pal (net)

NERO

33 nero

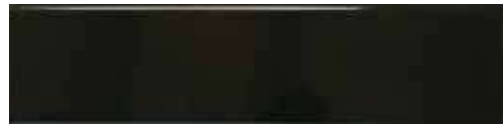

S52942

TC

tc 7



S53150

VINTAGE

325



S52554

332



S52558

335



S52568

334



S52564

IMBALLI . PACKING . EMBALLAGE . VERPACKUNG .

FORMATO - SIZE	PZ/BOX	ML/BOX	KG/ML	BOX/PALLET	ML/PALLET	KG/PALLET	EURO < 1 PALLET	EURO ≥1 PALLET
Battiscopa 8x33,3 (3 1/4"x13")	27	9	1,25	66	594	742,50	4,80 ml/m	

Contributo spese imballo € 10,00/pal (netto). - Packing charges € 10,00/pal (net)

IMBALLI . PACKING . EMBALLAGE . VERPACKUNG .

FORMATO - SIZE	PZ/BOX	ML/BOX	KG/ML	BOX/PALLET	ML/PALLET	KG/PALLET	EURO < 1 PALLET	EURO ≥1 PALLET
Battiscopa 8x33,3 (3 1/4"x13")	27	9	1,25	66	594	742,50	4,80 ml/m	

Contributo spese imballo € 10,00/pal (netto). - Packing charges € 10,00/pal (net)

BL

bl bianco



J86053

bl fumo



J86052

bl greige



J86174

bl ebano



J86049

bl noce



J86051

bl miele



J86050

CT

CT ICE



J88160

CT HONEY



J88159

CT IVORY



J88161

CT MUD



J88162

CT ECRÙ



J88158

IMBALLI . PACKING . EMBALLAGE . VERPACKUNG .

FORMATO - SIZE	PZ/BOX	ML/BOX	KG/ML	BOX/PALLET	ML/PALLET	KG/PALLET	EURO < 1 PALLET	EURO ≥1 PALLET
Battiscopa 8x45 (3 1/4"x18")	30	13,5	1,27	42	567	722	5,40 ml/m	

Contributo spese imballo € 10,00/pal (netto). - Packing charges € 10,00/pal (net)

IMBALLI . PACKING . EMBALLAGE . VERPACKUNG .

FORMATO - SIZE	PZ/BOX	ML/BOX	KG/ML	BOX/PALLET	ML/PALLET	KG/PALLET	EURO < 1 PALLET	EURO ≥1 PALLET
Battiscopa 8x45 (3 1/4"x18")	30	13,5	1,27	42	567	722	5,40 ml/m	

Contributo spese imballo € 10,00/pal (netto). - Packing charges € 10,00/pal (net)

DR

dr dark



J88609

dr greige



J88611

dr ivory



J88613

dr ecrù



J88610

dr honey



J88612

dr nut



J88814

IMBALLI . PACKING . EMBALLAGE . VERPACKUNG .

FORMATO - SIZE	PZ/BOX	ML/BOX	KG/ML	BOX/PALLET	ML/PALLET	KG/PALLET	EURO < 1 PALLET	EURO ≥1 PALLET
Battiscopa 8x45 (3 1/4"x18")	30	13,5	1,27	42	567	722	5,40 ml/m	

Contributo spese imballo € 10,00/pal (netto). - Packing charges € 10,00/pal (net)

EV

ev oak



J86733

ev brown



J86702

ev olive



J86705

ev greige



J86704

ev fog



J86703

IMBALLI . PACKING . EMBALLAGE . VERPACKUNG .

FORMATO - SIZE	PZ/BOX	ML/BOX	KG/ML	BOX/PALLET	ML/PALLET	KG/PALLET	EURO < 1 PALLET	EURO ≥1 PALLET
Battiscopa 8x45 (3 1/4"x18")	30	13,5	1,27	42	567	722	5,40 ml/m	

Contributo spese imballo € 10,00/pal (netto). - Packing charges € 10,00/pal (net)

GW

gw bianco



J86464

gw beige



J86463

gw noce



J86468

gw bruno



J86465

gw greige



J86466

gw nero



J86467

IMBALLI . PACKING . EMBALLAGE . VERPACKUNG .

FORMATO - SIZE	PZ/BOX	ML/BOX	KG/ML	BOX/PALLET	ML/PALLET	KG/PALLET	EURO < 1 PALLET	EURO ≥1 PALLET
Battiscopa 8x45 (3 1/4"x18")	30	13,5	1,27	42	567	722	5,40 ml/m	

Contributo spese imballo € 10,00/pal (netto). - Packing charges € 10,00/pal (net)

HS

hs 01



J85847

hs 02



J85848

hs 03



J85846

hs 04



J85948

hs 05



J85949

hs 06



J85950

hs 07



J85033

IMBALLI . PACKING . EMBALLAGE . VERPACKUNG .

FORMATO - SIZE	PZ/BOX	ML/BOX	KG/ML	BOX/PALLET	ML/PALLET	KG/PALLET	EURO < 1 PALLET	EURO ≥1 PALLET
Battiscopa 8x45 (3 1/4"x18")	30	13,5	1,27	42	567	722	5,40 ml/m	

Contributo spese imballo € 10,00/pal (netto). - Packing charges € 10,00/pal (net)

JU

ju brown



S54061

ju capucino



S54062

ju mud



S54065

ju light grey



S54064

ju honey



S54063

ju white



S54066

ju black



S54341

ju avorio



S54235

IMBALLI . PACKING . EMBALLAGE . VERPACKUNG .

FORMATO - SIZE	PZ/BOX	ML/BOX	KG/ML	BOX/PALLET	ML/PALLET	KG/PALLET	EURO < 1 PALLET	EURO ≥1 PALLET
Battiscopa 8x45 (3 1/4"x18")	30	13,5	1,27	42	567	722	5,40 ml/m	

Contributo spese imballo € 10,00/pal (netto). - Packing charges € 10,00/pal (net)

LC

3 1/4"x18"

lc barge beige



J88923

lc onsernone grigio



J88925

lc luserna multicolor



J88924

OT

ot cream



J89224

ot ivory



J89225

ot blend



J89223

IMBALLI . PACKING . EMBALLAGE . VERPACKUNG .

FORMATO - SIZE	PZ/BOX	ML/BOX	KG/ML	BOX/PALLET	ML/PALLET	KG/PALLET	EURO < 1 PALLET	EURO ≥1 PALLET
Battiscopa 8x45 (3 1/4"x18")	30	13,5	1,27	42	567	722	5,40 ml/m	

Contributo spese imballo € 10,00/pal (netto). - Packing charges € 10,00/pal (net)

QR

qr white



J89190

qr beige



J89187

qr light grey



J89189

qr grey



J89188

TA

ta chocolate



J84325

ta cappuccino



J84326

ta honey



J84327

ta cream



J84328

ta fog



J84586

ta ice



J84587

IMBALLI . PACKING . EMBALLAGE . VERPACKUNG .

FORMATO - SIZE	PZ/BOX	ML/BOX	KG/ML	BOX/ PALLET	ML/ PALLET	KG/ PALLET	EURO < 1 PALLET	EURO ≥1 PALLET
Battiscopa 8x45 (3 1/4"x18")	30	13,5	1,27	42	567	722	5,40 ml/m	

Contributo spese imballo € 10,00/pal (netto). - Packing charges € 10,00/pal (net)

TIMELESS

timeless greige



J89489

timeless ivory



J89491

timeless ecrù



J89488

timeless honey



J89490

timeless nut



J89492

TS

ts 01



J87421

ts 02



J87422

ts 03



J87423

ts 04



J87533

ts 05



J87536

IMBALLI . PACKING . EMBALLAGE . VERPACKUNG .

FORMATO - SIZE	PZ/BOX	ML/BOX	KG/ML	BOX/ PALLET	ML/ PALLET	KG/ PALLET	EURO < 1 PALLET	EURO ≥1 PALLET
Battiscopa 8x45 (3 1/4"x18")	30	13,5	1,27	42	567	722	5,40 ml/m	

Contributo spese imballo € 10,00/pal (netto). - Packing charges € 10,00/pal (net)

VN

vn dorè



J86918

vn brune



J86916

vn cendre



J86917

VS

vs panna



J85208

vs sabbia



J85209

vs miele



J85206

vs moro



J85207

vs fumo



J85205

vs naturale



J85295

IMBALLI . PACKING . EMBALLAGE . VERPACKUNG .

FORMATO - SIZE	PZ/BOX	ML/BOX	KG/ML	BOX/PALLET	ML/PALLET	KG/PALLET	EURO < 1 PALLET	EURO ≥1 PALLET
Battiscopa 8x45 (3 1/4"x18")	30	13,5	1,27	42	567	722	5,40 ml/m	

Contributo spese imballo € 10,00/pal (netto). - Packing charges € 10,00/pal (net)

WD

wd white



J86900

wd blue



J86897

wd green



J86899

wd brown



J86898

wd beige



J86896

IMBALLI . PACKING . EMBALLAGE . VERPACKUNG .

FORMATO - SIZE	PZ/BOX	ML/BOX	KG/ML	BOX/PALLET	ML/PALLET	KG/PALLET	EURO < 1 PALLET	EURO ≥1 PALLET
Battiscopa 8x45 (3 1/4"x18")	30	13,5	1,27	42	567	722	5,40 ml/m	

Contributo spese imballo € 10,00/pal (netto). - Packing charges € 10,00/pal (net)

PEZZI SPECIALI

40x120	680
100x100	681
80x80	682
60x60	683
60x100	683

40x120

I seguenti pezzi vengono prodotti per tutti gli articoli presenti nel formato 40x120.
The following pieces are produced for all items in size 40x120.

	Bordo rettilineo 30x120	Angolo rettilineo SX 30x120	Angolo rettilineo DX 30x120
Dimensione del pezzo	A: 1200mm B: 300mm SP: 20mm	A: 1200mm B: 300mm SP: 20mm	A: 1200mm B: 300mm SP: 20mm
Rettificato	€ 113,00	€ 159,00	€ 159,00
Toro	€ 130,00	€ 185,00	€ 185,00
Gocciolatoio passante			
Rettificato	€ 127,00	€ 179,00	€ 179,00
Toro	€ 145,00	€ 207,00	€ 207,00

	Copertina rettilinea 30x60	Angolo curvilineo interno 40x40 - r 10
Dimensione del pezzo	A: 600mm B: 300mm SP: 20mm	A: 400mm B: 300mm r: 10
Rettificato	-	€ 295,00
Toro	-	€ 295,00
Gocciolatoio passante		
Rettificato	€ 110,00	-
Toro	-	-

100x100

I seguenti pezzi vengono prodotti per tutti gli articoli presenti nel formato 100x100.
The following pieces are produced for all items in size 100x100.

	Bordo rettilineo 30x100	Angolo rettilineo SX 30x100	Angolo rettilineo DX 30x100
Dimensione del pezzo	A: 1000mm B: 300mm SP: 20mm	A: 1000mm B: 300mm SP: 20mm	A: 1000mm B: 300mm SP: 20mm
Rettificato	€ 102,00	€ 142,00	€ 142,00
Toro	€ 115,00	€ 164,00	€ 164,00
Gocciolatoio passante			
Rettificato	€ 115,00	€ 159,00	€ 159,00
Toro	€ 129,00	€ 183,00	€ 183,00

	Copertina rettilinea 30x100	Angolo curvilineo interno 100x100 - r 15	Angolo curvilineo interno 100x100 - r 30	Angolo curvilineo interno 50x50 - r10
Dimensione del pezzo	A: 1000mm B: 300mm SP: 20mm	A: 1000mm B: 300mm r: 15	A: 1000mm B: 300mm r: 30	A: 500mm B: 300mm r: 10
Rettificato	-	€ 560,00	€ 560,00	€ 305,00
Toro	-	€ 560,00	€ 560,00	€ 305,00
Gocciolatoio passante				
Rettificato	€ 207,00	-	-	-
Toro	-	-	-	-

80x80

I seguenti pezzi vengono prodotti per tutti gli articoli presenti nel formato 80x80.
The following pieces are produced for all items in size 80x80.

	Bordo rettilineo 30x80	Angolo rettilineo SX 30x80	Angolo rettilineo DX 30x80
Dimensione del pezzo	A: 800mm B: 300mm SP: 20mm	A: 800mm B: 300mm SP: 20mm	A: 800mm B: 300mm SP: 20mm
Rettificato	€ 77,00	€ 113,00	€ 113,00
Toro	€ 91,00	€ 132,00	€ 132,00
Gocciolatoio passante			
Rettificato	€ 87,00	€ 127,00	€ 127,00
Toro	€ 102,00	€ 147,00	€ 147,00

	Copertina rettilinea 30x80	Angolo curvilineo interno 80x80 - r 15	Angolo curvilineo interno 40x40 - r 10
Dimensione del pezzo	A: 800mm B: 300mm SP: 20mm	A: 800mm B: 300mm r: 15	A: 400mm B: 300mm r: 10
Rettificato	-	€ 495,00	€ 295,00
Toro	-	€ 495,00	€ 295,00
Gocciolatoio passante			
Rettificato	€ 164,00	-	-
Toro	-	-	-

60x60

I seguenti pezzi vengono prodotti per tutti gli articoli presenti nel formato 60x60.
The following pieces are produced for all items in size 60x60.

	Bordo rettilineo 30x60	Angolo rettilineo SX 30x60	Angolo rettilineo DX 30x60	Copertina rettilinea 30x60	Angolo curvilineo interno 60x60 - r 15
Dimensione del pezzo	A: 600mm B: 300mm SP: 20mm	A: 600mm B: 300mm SP: 20mm	A: 600mm B: 300mm SP: 20mm	A: 600mm B: 300mm SP: 20mm	A: 600mm B: 300mm r: 15
Rettificato	€ 46,40	€ 69,50	€ 69,50	-	€ 295,00
Toro	€ 54,00	€ 81,50	€ 81,50	-	€ 295,00
Gocciolatoio passante					
Rettificato	€ 52,00	€ 79,00	€ 79,00	€ 99,50	-
Toro	€ 59,70	€ 91,00	€ 91,00	-	-

60x100

I seguenti pezzi vengono prodotti per tutti gli articoli presenti nel formato 60x100.
The following pieces are produced for all items in size 60x100.

	Bordo rettilineo 30x100	Angolo rettilineo SX 30x100	Angolo rettilineo DX 30x100	Copertina rettilinea 30x60	Angolo curvilineo interno 60x60 - r 15
Dimensione del pezzo	A: 1000mm B: 300mm SP: 20mm	A: 1000mm B: 300mm SP: 20mm	A: 1000mm B: 300mm SP: 20mm	A: 600mm B: 300mm SP: 20mm	A: 600mm B: 300mm r: 15
Rettificato	€ 99,50	€ 142,00	€ 142,00	-	€ 295,00
Toro	€ 115,00	€ 164,00	€ 164,00	-	€ 295,00
Gocciolatoio passante					
Rettificato	€ 113,00	€ 159,00	€ 159,00	€ 99,50	-
Toro	€ 129,00	€ 183,00	€ 183,00	-	-

INFORMAZIONI TECNICHE

CERAMICA.INFO	686
SMART EDGE	688
B-SLIM	690
CARATTERISTICHE TECNICHE	692
CERTIFICAZIONI	694
CONSIGLI DI POSA	697-698
LEGENDA	701
INDICE DI VARIAZIONE	701
CONDIZIONI GENERALI DI VENDITA	702
SCHEMI DI POSA	704

LA CERAMICA. UNA SCELTA SICURA.



SICURA SAFE

La ceramica è un materiale sicuro, che viene dalla terra, quindi naturale, non contiene plastica ed è completamente riciclabile.

Ceramic is a safe, natural material that originates from the earth. It does not contain plastic and is completely recyclable.



IGIENICA HYGIENIC

La ceramica è uno dei materiali più igienici, non fa odore, si pulisce facilmente con tutti i prodotti per la pulizia della casa.

Ceramic is one of the most hygienic of all materials. It's odourless and easy to clean using any household detergent.

CERAMIC. A SAFE CHOICE.



RESISTENTE RESISTANT

La ceramica è un materiale forte perché non si deforma, non gela e resiste ai detergenti chimici più aggressivi.

Ceramic is a strong material that does not change shape or freeze and is resistant to even the most aggressive chemical detergents.



VERSATILE VERSATILE

La ceramica - con la sua infinita varietà di formati e superfici - è adatta per ogni ambiente, ideale per pavimenti e pareti, per piani di lavoro e tavoli.

With its infinite variety of sizes and surfaces, ceramic is suitable for any application, whether floors or walls, countertops or tables.



DURA A LUNGO LONG-LASTING

La ceramica è un materiale duraturo, inalterabile, si pulisce facilmente ed è sempre come nuovo anche col passare del tempo.

Ceramic is a durable and hard-wearing material. It's easy to clean and always looks as good as new.



NON BRUCIA IT DOES NOT BURN

La ceramica è un materiale sicuro, che viene dalla terra, quindi naturale, non contiene plastica ed è completamente riciclabile.

It does not burn and in the event of fire does not release substances that are harmful to people or the environment.



STABILE STABLE

Un pavimento in ceramica è pratico e stabile e si posa facilmente nei negozi, nei ristoranti, negli uffici e in ogni tipo di locale.

A ceramic floor is practical, stable and can be easily skillfully installed in shops, restaurants, offices and surfaces of all kinds.



AMA L'AMBIENTE ENVIRONMENT-FRIENDLY

La ceramica è un materiale sostenibile che rispetta l'ambiente e la salute perché è prodotta in conformità con tutte le normative europee.

Ceramic is a sustainable material that is healthy and environment-friendly because it is produced in full compliance with European and American standards.

DISTANZIALE E CONICITÀ SMART EDGE SMART EDGE SPACER & TAPER

- Piastrella prodotta con tecnologia SMART EDGE, senza conicità e senza distanziale, che consente comunque di non avere scheggiature dei bordi fra le piastrelle.
- *Tile made with SMART EDGE Technology, without tapering or a spacer but which still makes it possible not to have chipping of the edges between the tiles.*
- *Carrelage réalisé grâce à SMART EDGE Technology, sans formes coniques et sans entretoises, permet néanmoins d'éviter les brèches sur le bord des carrelages.*
- *Technisch innovativ hergestellte Fliese aus der SMART EDGE Technology ohne Konizität und ohne Abstandhalter, die dennoch das Splittern der Ränder zwischen den Fliesen verhindern.*

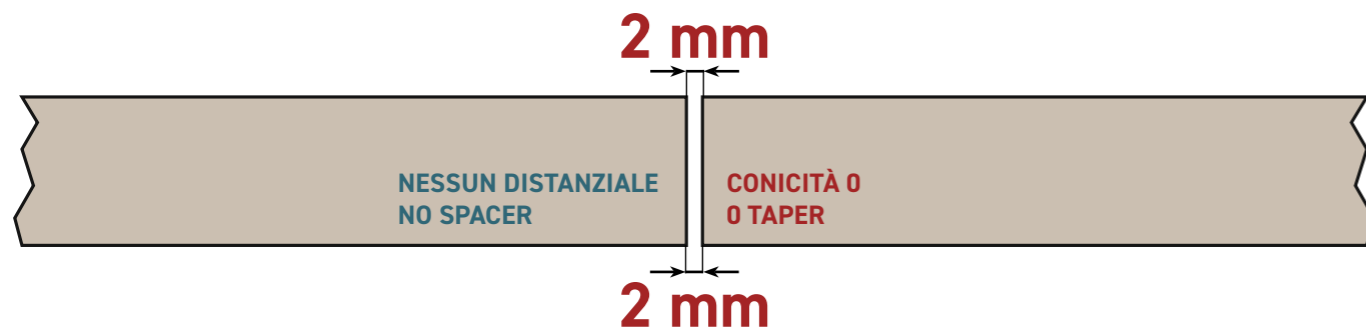

RAGGIO DI CURVATURA SMART EDGE: CURVATURA ZERO SMART EDGE'S RADIUS OF CURVATURE: ZERO CURVATURE

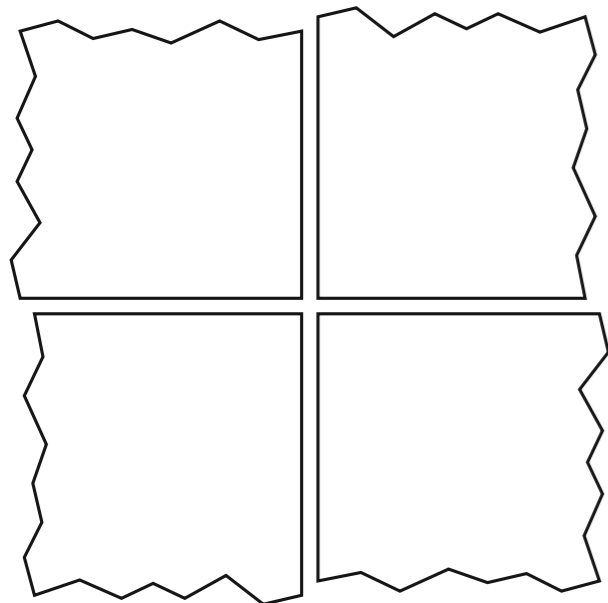

- Piastrella, prodotta con raggio di curvatura 0 made in Rondine, per conferire al prodotto l'aspetto estetico tipico delle cementine
- *Tile made with a radius of curvature of 0 mm made in Rondine to produce the typical appearance of cement tiles*
- *Carrelage réalisé avec un rayon de cintrage de 0 mm made in Rondine pour conférer au produit l'aspect esthétique typique des carreaux-ciments (« cimentine »)*
- *Fliese mit Krümmungsradius von 0 made in Rondine, um dem Produkt das typische Aussehen einer Zementfliese zu verleihen*

LA NUOVA TECNOLOGIA IDEATA DAL REPARTO DI RICERCA E SVILUPPO DI CERAMICA RONDINE, CHE CONSENTE DI OTTENERE UNA PIASTRELLA DA PRESSA CON BORDO SENZA CONICITÀ E SENZA DISTANZIALE, DEL TUTTO ASSIMILABILE AL PRODOTTO RETTIFICATO.

the new technology designed by the Rondine ceramic r&d department, which makes it possible to obtain a press tile with an edge without taper and without a spacer, completely similar to the rectified product.

DISTANZIALE E CONICITÀ CERAMICHE TRADIZIONALI TRADITIONAL CERAMICS SPACER & TAPER

- Piastrella tradizionale, prodotta col distanziale, per evitare che eventuali contatti in linea producano scheggiature dei bordi, e conicità per agevolare l'estrazione del manufatto dagli stampi.
- *Traditional tile made with a spacer to prevent chipping of the edges due to contact, and with tapering to facilitate tile extraction from the moulds.*
- *Carrelage traditionnel réalisé avec des entretoises pour éviter que des contacts éventuels adaptés n'ébrèchent les bords et des formes coniques pour faciliter l'extraction du carreau de son moule.*
- *Traditionelle Fliese, hergestellt mit Abstandhalter, um zu verhindern, dass eventuelle Kontakte die Ränder zersplittern können und mit Konizität, um das Entnehmen des Produkts aus der Form zu erleichtern.*

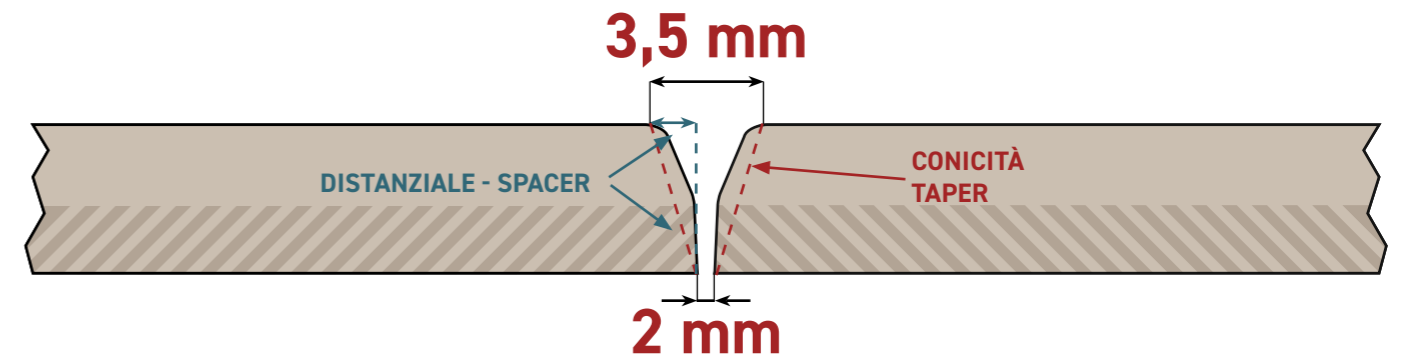

RAGGIO DI CURVATURA CERAMICHE TRADIZIONALI TRADITIONAL CERAMICS'S RADIUS OF CURVATURE

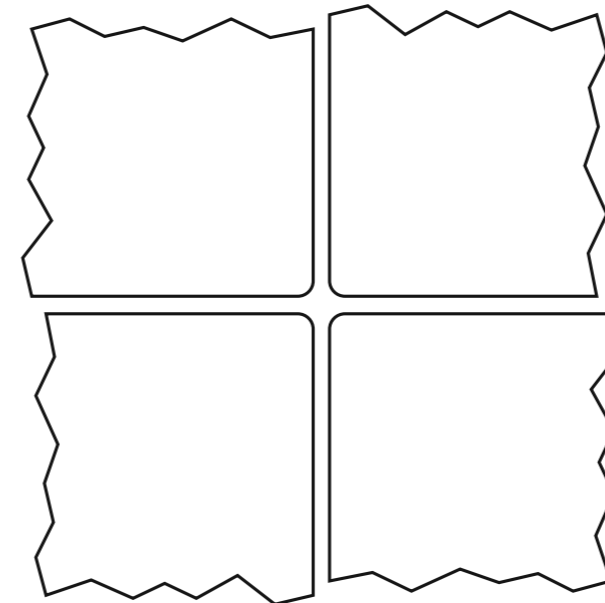

- Piastrella tradizionale, prodotta con raggio di curvatura di 1-2 mm, per ridurre la scheggiatura degli angoli
- *Traditional tile made with a radius of curvature of 1-2 mm to reduce chipping of the corners*
- *Carrelage traditionnel muni d'un rayon de cintrage de 1 à 2 mm pour réduire le risque que les coins ne s'ébrèchent.*
- *Traditionelle Fliese mit Krümmungsradius von 1-2 mm, um das Zersplittern der Ecken zu reduzieren.*

6 mm

RIVESTIMENTO ESISTENTE
EXISTING COVERING / REVÊTEMENT EXISTANT/
EXISTIERENDE VERBLENDUNG

ADESIVO PER PIASTRELLE
TILE GLUE / COLLE POUR CARRELAGES /
FLIESENKLEBER

6 MM RONDINE BRICK



IDEALE PER LE RISTRUTTURAZIONI

PIASTRELLA + COLLA IN MENO DI 1 CM

Ideal for renovations
Thickness of glue and tile less than 1 cm

Idéal pour les rénovations
Carreau + colle moins d'un centimètre

Ideal für Renovierungen
Verklebung der Fliesen weniger als 1 cm

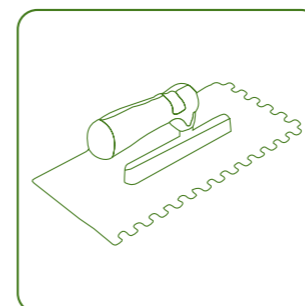

FACILE E VELOCE DA INSTALLARE

35 % IN MENO TEMPI DI INSTALLAZIONE

Easy to install
Save 35% of installation time

Facile et rapide à installer
35% en moins sur le temps d'installation

Einfach und schnell zu installieren
35% zeitsparend für die Installation



MATERIALE ULTRA LEGGERO

RIDUZIONE DEL 40 % DEL PESO

Ultralight material
40% weight reduction

Matériau ultraléger
Réduction du poids de 40%

Ultraleichtes Material
40% Gewichtsreduzierung



MAGGIORE SOSTENIBILITÀ AMBIENTALE









MINORI EMISSIONI DI CO2 GRAZIE AL MINOR UTILIZZO DI MATERIE PRIME

Highly eco-friendly
The efficient use of raw materials reduces the CO2 emissions





Meilleure durabilité environnementale
Moins d'émissions de CO2 en réduisant l'utilisation des matières premières

Umweltfreundlich
Der Verbrauch von wenigen Rohstoffen reduziert die CO2 Emissionen

Caratteristiche tecniche Technical properties

CARATTERISTICA TECNICA - TECHNICAL PROPERTY CARACTERISTIQUE TECHNIQUE - TECHNISCHE DATEN		METODO DI PROVA TESTING METHOD MÉTHODE D'ESSAI PRÜFNORMEN	VALORE PRESCRITTO DELLA NORMA - REQUIRED STANDARDS VALEUR PRESCRIPTE PAR LES NORMES - NORMVORGABE
	Assorbimento d'acqua Water Absorption Absorption d'eau Wasseraufnahme	UNI EN ISO 10545-3	≤ 0,5%
	Resistenza a basse/alte concentrazioni di acidi/alcali Resistenza ai prodotti chimici di uso domestico e agli additivi per piscina Resistance to low/high concentrations of alkalis and acids Resistance to household chemical products and swimming pool additives Résistance à faibles/ fortes concentrations d'acides et d'alcalis Résistance aux produits chimiques à usage domestique et aux additifs pour piscine Chemikalien beständigkeit und gegen haushaltschemikalien und badewasserzusätze химическая стойкость	UNI EN ISO 10545-13	Classe dichiarata Classe minima B Declared class Minimum class B Classe déclarée Minimum classification B Angewebenen Klasse Mindestklasse B
	Resistenza alla flessione Bending Strength Résistance à la flexion Bruchlast	UNI EN ISO 10545-4	R ≥ 35 N / mm ² S > 700 N (spessore < 7,5 mm) S > 1300 N (spessore ≥ 7,5 mm)
	Resistenza al gelo Frost resistance Résistance au gel Frostbeständigkeit	UNI EN ISO 10545-12	Nessun campione deve presentare rotture o alterazioni apprezzabili della superficie. Samples must not show alterations on the surface. Les échantillons ne doivent pas présenter de ruptures ou d'altérations considérables sur la surface. Die Muster müssen keine Bruch oder Schäden auf der Oberfläche präsentieren.
	Durezza di Mohs Hardness in Mohs degrees Dureté de Mohs Ritzhärte nach Mohs	UNI EN 101	≥ 5° Mohs
	Resistenza alle macchie Stain resistant Resistance aux taches Fleckbeständigkeit	UNI EN ISO 10545-14	Classe > 3 Class > 3 Classe > 3 Klasse > 3
	Resistenza all'abrasione superficiale Superficial abrasion resistance Resistance à la abrasion superficielle PEI Klassifizierung	Classificazione Interna Internal Classification System	Classi di abrasione da I a V Abrasion class from I to V Classe d'abrasion de I à V Abriebklassen I bis V
	Resistenza all'abrasione profonda Deep abrasion resistance Résistance à l'abrasion profonde Tiefenverschleiß	UNI EN ISO 10545-6	≤ 175 mm ³
	Resistenza allo scivolamento (coefficiente di attrito) Slip resistance (coefficient of friction) Résistance au glissement (coefficient de friction) Rutschfestigkeit (Reibungskoeffizient)	DIN 51130 DIN 51097 B.C.R.A. Rep. CEC/81 Dcof ANSI A137.1:2012 BS 7976-2 (pendulum)	Valore dichiarato Declared value Valeur déclarée Wertangabe μ > 0,40 > 0,42 0-24 Scivoloso Slippery Glissant Rutschig 25-35 Scivolosità moderata Moderately slippery Glissance modérée Großer Haftriebwert >36 Basso rischio scivolamento Low slipping risk Risque de glissement faible Sehr Großer Haftriebwert

Caratteristiche tecniche Technical properties

CARATTERISTICA TECNICA - TECHNICAL PROPERTY CARACTERISTIQUE TECHNIQUE - TECHNISCHE DATEN		METODO DI PROVA TESTING METHOD MÉTHODE D'ESSAI PRÜFNORMEN	VALORE PRESCRITTO DELLA NORMA - REQUIRED STANDARDS VALEUR PRESCRIPTE PAR LES NORMES - NORMVORGABE			
			N < 7 cm (mm)	7 cm ≤ N < 15 cm (mm)	N ≥ 15 cm (mm)	
	Lunghezza e larghezza Length and width Longueur et largeur Länge und Breite	ISO 10545-2	± 0,5 (*)	± 0,9 (*)	± 0,6 (*)	± 2,0 (*)
	Spessore Thickness Épaisseur Dicke		± 0,5 (**)	± 0,5 (**)	± 0,5 (**)	± 0,5 (**)
	Rettilinearità degli spigoli Straightness of sides Rectitude des bords Geradheit der kanten		n.a. (***)	± 0,75 (***)	± 0,5 (***)	± 1,5 (***)
	Ortogonalità Squareness Rectangularité Rechtwinkligkeit		n.a. (****)	± 0,75 (****)	± 0,5 (****)	± 2,0 (****)
	Planarità Planarity Planéité de surface Ebenflächigkeit		c.c. / n.a e.c. / n.a w. / n.a	c.c. ± 0,75 e.c. ± 0,75 w. ± 0,75	c.c. ± 0,5 e.c. ± 0,5 w. ± 0,5	c.c. ± 2,0 e.c. ± 2,0 w. ± 2,0

(*) Deviazione ammissibile, in % oppure mm, della dimensione media di ogni piastrella (2 oppure 4 lati) dalla dimensione di fabbricazione (W).
(*) The permissible deviation, in % or mm, of the average size for each tile (2 or 4 sides) from work size (W).
(*) Écart admissible, en % ou en mm, de la taille moyenne de chaque carreau (2 ou 4 faces) par rapport à la dimension de fabrication (W).
(*) Zulässige Abweichung der durchschnittlichen Größe jeder Fliese (2 oder 4 Seiten) in % oder mm vom Herstellungsmaß (W).

(**) Deviazione ammissibile, in % oppure mm, dello spessore medio di ogni piastrella dallo spessore riportato nella dimensione di fabbricazione (W).
(**) The permissible deviation, in % or mm, of the average thickness for each tile from the work size (W).
(**) Écart admissible, en % ou en mm, de l'épaisseur moyenne de chaque carreau par rapport à l'épaisseur indiquée dans la dimension de fabrication (W).
(**) Zulässige Abweichung der durchschnittlichen Dicke jeder Fliese in % oder mm von der in der Herstellungsabmessung (W) angegebenen Dicke.

(***) Deviazione massima ammissibile di rettilinearità, in % oppure mm, in rapporto alle dimensioni di fabbricazione (W) corrispondenti.
(***) The maximum permissible deviation from straightness, in % or mm, related to the corresponding work sizes (W).
(***) Écart de rectitude maximum admissible, en % ou en mm, par rapport aux dimensions de fabrication (W) correspondantes.
(***) Maximal zulässige Geradheitsabweichung in% oder mm in Bezug auf die entsprechenden Fertigungsabmessungen (W).

(****) Deviazione massima ammissibile di ortogonalità, in % oppure mm, in rapporto alle dimensioni di fabbricazione (W) corrispondenti.
(****) The maximum permissible deviation from rectangularity, in % or mm, related to the corresponding work size (W).
(****) Écart d'orthogonalité maximum admissible, en % ou en mm, par rapport aux dimensions de fabrication (W) correspondantes.
(****) Maximal zulässige Abweichung der Orthogonalität in% oder in mm in Bezug auf die entsprechenden Herstellungsabmessungen (W).

c.c. Deviazione massima ammissibile della curvatura del centro, in % oppure mm, in rapporto alla diagonale calcolata secondo le dimensioni di fabbricazione (W).
c.c. The maximum permissible deviation from centre curvature, in % or mm, related to the diagonal calculated from the work sizes (W).
c.c. Écart maximum admissible de la courbure du centre, en % ou en mm, par rapport à la diagonale calculée en fonction des dimensions de fabrication (W).
c.c. Maximal zulässige Abweichung der Krümmung des Mittelpunkts in% oder mm in Bezug auf die Diagonale, berechnet nach den Herstellungsmaßen (W).

e.c. Deviazione massima ammissibile della curvatura dello spigolo, in % oppure mm, in rapporto alle dimensioni di fabbricazione (W).
e.c. The maximum permissible deviation from edge curvature, in % or mm, related to the corresponding work sizes (W).
e.c. Écart maximum admissible de la courbure du coin, en% ou en mm, par rapport aux dimensions de fabrication (W).
e.c. Maximal zulässige Abweichung der Krümmung der Ecke in% oder mm von den Herstellungsmaßen (W).

w. Deviazione massima ammissibile dello svergolamento, in % o mm, in rapporto alla diagonale calcolata secondo le dimensioni di fabbricazione (W).
w. The maximum permissible deviation from warpage, in % or mm, related to diagonal calculated from the work size (W).
w. Écart de gauchissement maximum admissible, en % ou en mm, par rapport à la diagonale calculé en fonction des dimensions de fabrication (W).
w. Maximal zulässige Verzugabweichung in % oder mm in Bezug auf die Diagonale, berechnet nach den Abmessungen von Herstellung (W).

Le caratteristiche tecniche indicate nei cataloghi di linea e nel Catalogo Generale, e in qualsiasi documento di promozione commerciale di ITALCER S.p.A., hanno lo scopo di dare un'indicazione dei valori riscontrati nei vari lotti e nelle varie tonalità del prodotto, pertanto differenze rispetto a tali valori indicativi non possono essere oggetto di contestazione.

All technical features stated in leaflets, in master brochure and in merchandising of ITALCER S.p.A. are meant to be an indication of an average of figures recorded within a span determined by international law) in several production runs, therefore a slight discrepancy in quality figures of a certain batch in relation to these figures cannot be considered a production failure.

Les caractéristiques techniques mentionnées dans les catalogues de ligne et dans le catalogue général et dans tous les documents de promotion commerciale de ITALCER S.p.A. ont le but de fournir une indications des valeurs rencontrés dans les différents lots et dans les différentes tonalités du produit et donc les différences par rapport à ces valeurs indicatives ne peuvent pas faire l'objet des réclamations.

Die in den Linienkatalogen und im Gesamtkatalog sowie in den Werbedokumenten für ITALCER S.p.A. angegebenen technischen Merkmale sollen einen Hinweis auf die Werte geben, die in den verschiedenen Chargen und in den verschiedenen Produktfarben gefunden wurden, weshalb sich diese unterschiedlichen Richtwerte können nicht bestritten werden.

Salute e Sicurezza sul lavoro Occupational health and safety

CERTIFICAZIONE - CERTIFICATION CERTIFICATION - BESCHEINIGUNG	NUMERO - NUMBER NOMBRE - ZAHL	DESCRIZIONE - DESCRIPTION - DESCRIPTION - BESCHREIBUNG
 UNI ISO 45001:2018 Salute e Sicurezza sul lavoro	Certificato n° 27008 04/02/2020	<p>Lo standard ISO 45001 è la prima norma internazionale a definire gli standard minimi di buona pratica per la protezione dei lavoratori in tutto il mondo. Uno strumento di tutela del patrimonio di salute dei lavoratori, un mezzo per instaurare un rapporto proficuo e trasparente con Organizzazioni Sindacali ed Enti di Controllo, ma soprattutto l'evidenza che si può e si deve fare business nel pieno rispetto dei diritti della Persona.</p> <p><i>ISO 45001 is the first international standard to define the minimum best practices for worker protection all over the world. A tool to protect worker health, a means to establish a profitable and transparent relationship with trade unions and supervisory bodies, but especially proof that it is possible and indeed necessary to do business with full respect for people's rights.</i></p>

Qualità e Sostenibilità Quality and Sustainability

Ceramica Rondine è parte del gruppo Italcer, azienda leader nella produzione di piastrelle ceramiche, che si caratterizza non solo per la qualità dei prodotti, ma anche per la sostenibilità sociale ed ambientale della sua gestione. Per noi è impensabile parlare di qualità, successo, miglioramento e sviluppo senza estendere questi concetti ai temi della protezione della Risorsa Umana e della tutela dell'Ambiente, che rappresentano per Italcer la cifra del suo fare impresa e fattore strategico per assicurare successo durevole e capacità di competere a livello mondiale.

Ceramica Rondine is part of the Italcer group, a leader in the production of ceramic tiles, which is known not only for product quality, but also for its socially and environmentally sustainable management. For us, it is unthinkable to speak of quality, success, improvement and development without extending these concepts to the protection of Human Resources and the Environment, which for Italcer represent its way of doing business and a strategic factor to ensure lasting success and the capacity to compete at global level.

CERTIFICAZIONE - CERTIFICATION CERTIFICATION - BESCHEINIGUNG	NUMERO - NUMBER NOMBRE - ZAHL	DESCRIZIONE - DESCRIPTION - DESCRIPTION - BESCHREIBUNG
 UNI EN ISO 9001:2015 Qualità	Certificato n° 27007 30/05/2019	<p>Il Sistema di gestione per la qualità ISO 9001 è il "contenitore" che assicura il rispetto di tutti i requisiti cogenti e volontari sottoscritti. Fornisce alla direzione una base dati completa, aggiornata e affidabile che consente di prendere decisioni consapevoli e tempestive, e promuove il miglioramento sinergico e coerente in tutti i processi gestiti dai diversi standard.</p> <p><i>The ISO 9001 quality management system is the "container" which ensures respect for all requirements, both binding and voluntary. It provides the management with a complete, updated and reliable database which makes it possible to take knowledgeable and prompt decisions, and promotes synergistic and consistent improvement across all processes managed by the various standards.</i></p>

Certificazioni Ambientali Environmental Certifications

Italcer adotta e mantiene attivo un processo sistematico di verifica, misura e monitoraggio delle performance dei suoi processi ambientali, che assicura il rispetto dei requisiti cogenti, consente di riesaminare lo stato della gestione e permette di intervenire con le adeguate azioni correttive e preventive per superare le criticità individuate. L'adozione di un Sistema di Gestione Ambientale certificato conforme allo standard ISO 14001 ed al Regolamento EMAS, di un Sistema di Gestione per l'Energia e di altri standard ambientali costituiscono tappe significative di un percorso di crescita attraverso il quale vogliamo dare il nostro contributo ad uno Sviluppo Sostenibile e ad un dialogo trasparente e costruttivo con le Parti Interessate.

Italcer applies and updates a systematic performance check, measurement and monitoring process for its environmental processes, which ensures respect for binding requirements, enables it to review the management status and apply the suitable corrective and preventive actions to overcome any critical points identified. The adoption of a certified Environmental Management System compliant with the ISO 14001 standard and the EMAS Regulation, an Energy Management System and other environmental standards constitute significant steps on a path of growth, whereby we strive to provide our contribution to Sustainable Development and transparent and constructive dialogue with the Relevant Parties.

CERTIFICAZIONE - CERTIFICATION CERTIFICATION - BESCHEINIGUNG	NUMERO - NUMBER NOMBRE - ZAHL	DESCRIZIONE - DESCRIPTION - DESCRIPTION - BESCHREIBUNG
 DT 55 Italcer S.p.A. è socia del Green Building Council Italia Italcer S.p.A. is a member of Green Building Council Italy	P1059 del 21/10/2008	<p>Ceramica Rondine/Italcer è associata al Green Building Council Italia, organismo indipendente che ha come obiettivo la diffusione di una cultura dell'edilizia sostenibile ed in particolare la promozione del sistema di certificazioni LEED (Leadership in Energy and Environmental Design). I prodotti di Ceramica Rondine contengono percentuali di materia prima riciclata superiori anche al 50%, consentendo ai loro utilizzatori di accedere all'ottenimento di crediti LEED.</p> <p>Per saperne di più visita il sito www.gbctalia.org.</p> <p><i>Ceramica Rondine / Italcer is associated with Green Building Council Italia, an independent body whose goal is to promote a culture of sustainable building construction and in particular the promotion of the LEED (Leadership in Energy and Environmental Design) certification system. Ceramica Rondine products contain recycled raw materials even in excess of 50%, allowing their users to obtain LEED credits. To find out more visit www.gbctalia.org.</i></p>

Certificazioni Ambientali Environmental Certifications

CERTIFICAZIONE - CERTIFICATION CERTIFICATION - BESCHEINIGUNG	NUMERO - NUMBER NOMBRE - ZAHL	DESCRIZIONE - DESCRIPTION - DESCRIPTION - BESCHREIBUNG
 EMAS Eco-Management and Audit Scheme	IT 000907 del 16/5/2008	<p>Eco-Management and Audit Scheme (EMAS) è uno strumento volontario creato dalla Comunità Europea al quale possono aderire volontariamente le aziende per valutare e migliorare le proprie prestazioni ambientali, fornendo al pubblico e ad altri soggetti interessati informazioni sulla propria gestione ambientale. Scopo prioritario dell'EMAS è contribuire alla realizzazione di uno sviluppo economico sostenibile, ponendo in rilievo il ruolo e le responsabilità delle imprese e promuovendone il miglioramento continuo.</p> <p>Il sistema di gestione ambientale richiesto dallo standard EMAS è basato sulla norma ISO 14001:2004, mentre il dialogo aperto con il pubblico viene perseguito prescrivendo che le organizzazioni pubblichino una Dichiarazione Ambientale in cui sono riportati informazioni e dati salienti dell'azienda in merito ai suoi aspetti e impatti ambientali.</p> <p><i>The Eco-Management and Audit Scheme (EMAS) is a voluntary initiative created by the EU, which companies can participate in voluntarily, to assess and improve their environmental performance, providing the public and other relevant parties with information on their environmental management practices. The main priority of EMAS is to contribute to the implementation of sustainable economic development, highlighting the roles and responsibilities of companies and promoting their continuous improvement. The environmental management system stipulated by the EMAS standard is based on the ISO 14001:2004 standard, while open discussion with the public is pursued by stipulating that organisations publish an Environmental Declaration which outlines key details and information about the company, with regard to environmental aspects and impact.</i></p>
 UNI CEI EN ISO 50001:2018 Sistema di gestione per l'energia	Certificato n° 26196 18/10/2018	<p>L'obiettivo della certificazione ISO 50001 è quello di consentire che un'organizzazione persegua, con un approccio sistematico, il miglioramento continuo delle proprie prestazioni energetiche. Per Italcer consiste nel naturale completamento del sistema di gestione ambientale, con importanti ricadute anche sul piano dell'efficienza economica.</p> <p><i>The goal of the ISO 50001 certification is to enable an organisation to systematically pursue the continuous improvement of its energy performance. For Italcer, this is the natural complement to the environmental management system, with important impacts in terms of economic efficiency as well.</i></p>
 UNI EN ISO 14001:2015 Sistema di gestione ambientale	Certificato n° 12762 24/01/2008	<p>La certificazione ISO 14001 dimostra che l'azienda ha un sistema di gestione adeguato a tenere sotto controllo gli impatti ambientali delle proprie attività, e ne ricerca sistematicamente il miglioramento.</p> <p><i>The ISO 14001 certification demonstrates that the company has a management system suited to keeping the environmental impact of its activities under control, and systematically strives for improvement.</i></p>
 EPD	EPD - COI - 20160202 ICG1 - IT Confindustria Ceramica	<p>EPD è una dichiarazione ambientale di prodotto certificata e verificata da un soggetto indipendente che fornisce un'informazione chiara e confrontabile relativamente alle performance ambientali lungo tutto il suo ciclo di vita, conformemente a quanto stabilito dallo standard ISO 14025. L'industria ceramica italiana si è dotata di questo strumento dal 2015.</p> <p><i>EPD is an independently certified and verified environmental product declaration which provides clear and comparable information relating to environmental performance throughout its entire lifecycle, in compliance with the ISO 14025 standard. The Italian ceramics industry has adopted this instrument since 2015.</i></p>
 GOOD PHYTOSANITARY PRACTICES		<p>I marchi commerciali di Italcer sono inseriti nel Registro delle Aziende Qualificate per il rispetto delle Linee Guida del programma "Good Phytosanitary Practices (GPP)", uno standard finalizzato al miglioramento delle pratiche fitosanitarie per procedure di spedizione di container verso gli Stati Uniti.</p> <p>Una certificazione strategica per il miglioramento dei rapporti con gli operatori di uno dei mercati più importanti al mondo.</p> <p><i>Italcer's trademarks are included in the Register of Qualified Companies for their respect for the Guidelines of the "Good Phytosanitary Practices (GPP)" programme, a standard intended to improve phytosanitary practices for container shipping to the United States. A strategic certification for the improvement of relationships with operators in one of the most important markets in the world.</i></p>

CERTIFICAZIONE - CERTIFICATION CERTIFICATION - BESCHEINIGUNG	NUMERO - NUMBER NOMBRE - ZAHL	DESCRIZIONE - DESCRIPTION - DESCRIPTION - BESCHREIBUNG
 <p>UPEC Carreaux céramiques pour revêtements de sol</p>	825-2.0-20 828-2.0-20	<p>In seguito a valutazione positiva da parte dell'ente francese CSTB, Italcer è riconosciuta azienda produttrice di piastrelle certificate UPEC. Tale marchio costituisce un riconoscimento di eccellenza della qualità, riguardante sia il prodotto finito che l'intera unità produttiva in cui questo viene realizzato. Le unità produttive di Rubiera e Vetto sono entrambe certificate. I certificati di riferimento sono: n° 825-2.0-20 e n° 828-2.0-20</p> <p>Certificazione F+ per prodotti spessorati. Certificato n° 635-F/135-0.0/19</p> <p>La lista completa dei prodotti certificati, soggetta a continui aggiornamenti, è consultabile al seguente link: http://webapp.cstb.fr/upec-ceramique/index.php?view=TitulaireListeProduits&sid=192&tid=1</p> <p><i>Following the positive assessment by the French entity CSTB, Italcer was recognised as a UPEC certified tile manufacturer. This mark recognises excellent quality, regarding both the finished product and the entire production unit in which it is made. The Rubiera and Vetto production units are both certified. The reference certificates are: no. 825-2.0-20 and no. 828-2.0-20</i></p> <p><i>F+ certification for extra-thick products. Certificate no. 635-F/135-0.0/19</i></p> <p><i>The full, continuously updated list of certified products may be consulted at the following link: http://webapp.cstb.fr/upec-ceramique/index.php?view=TitulaireListeProduits&sid=192&tid=1</i></p>
 <p>UPEC-F+</p>	635-F/135-0.0/19	
 <p>Certificazione SQM Saso Quality Mark</p>	20200141571 14/07/2020	<p>Italcer ha ottenuto con i suoi marchi, certificazione di qualità SQM (Saso Quality Mark), riconosciuta da ente saudita di certificazione, finalizzata all'esportazione di prodotti in Arabia Saudita, importante sbocco commerciale del Middle-East.</p> <p><i>With its trademarks, Italcer has obtained the SQM (Saso Quality Mark) quality certification, recognised by a Saudi certification entity, for the export of products to Saudi Arabia, an important end market in the Middle East.</i></p>
 <p>Italcer - CE</p>	001CPR2013-07-14	<p>Italcer ha provveduto ad assolvere agli obblighi derivanti dalla Marcatura CE per le piastrelle di ceramica pressate a secco per pavimenti e pareti interni ed esterni.</p> <p><i>Italcer has fulfilled all its obligations for the application of EC marking to its dry-pressed ceramic tiles for interior and exterior floors and walls.</i></p>
 <p>Italcer - CCC China Compulsory Certificate</p> <p>放射性水平A类</p>	2005052102001054	<p>I prodotti Italcer sono conformi alle specifiche richieste per l'ottenimento del certificato cinese obbligatorio, comunemente noto come marchio CCC (acronimo dell'inglese China Compulsory Certificate).</p> <p><i>Italcer products comply with the specific requirements for obtaining the China Compulsory Certificate (CCC) mark.</i></p>
 <p>Italcer - VOC-COV</p>		<p>La certificazione VOC è un sistema che attesta la quantità di composti organici volatili rilasciata da un prodotto e lo etichetta in base a una serie di classi di merito, in un range compreso tra A+, la classe migliore, e C, la classe peggiore. I prodotti Italcer sono in classe A+, perché non rilasciano nell'ambiente sostanze nocive per l'uomo.</p> <p><i>VOC certification is a system that certifies the quantity of volatile organic compounds released by a product and labels it based on a series of classes, ranged between A+, the best class, and C, the worst class. Italcer products are in class A+, because they do not release into the atmosphere any substances that are harmful to humans.</i></p>



Il termine del ciclo di vita del prodotto si ha con la demolizione delle piastrellature. I detriti provenienti dalla demolizione delle piastrellature sono rottami di materiali ceramici, dunque di materiali inerti (non reattivi, chimicamente e fisicamente stabili, resistenti ad esposizione prolungata anche a condizioni estreme dal punto di vista termico, idrometrico e chimico).
I detriti di demolizione di piastrellature possono essere collocati nell'ambiente senza rischi particolari, ed anche trovare impiego nella preparazione di sottofondi, etc.

The end of the life cycle of the product comes with the demolition of the tiling. Debris from the tiling demolition are scraps of ceramic tiles, therefore inert materials (non-reactive, chemically and physically stable, resistant to even prolonged exposure to extreme thermal, chemical and hydrometric conditions).
Debris from the demolition of ceramic tiles can be placed safely in the environment, and also can be used in the preparation of substrates, etc.

La fin du cycle de vie du produit est représenté par la démolition du carrelage. Les débris provenant de cette démolition sont des matériaux céramiques, donc des matériaux inertes (non réactifs, chimiquement et physiquement stables, résistants aux expositions prolongées, même à des conditions thermiques, hydrométriques et chimiques extrêmes).
Les débris de démolition en mosaïque peuvent être placés dans l'environnement sans risques particuliers et ils peuvent également être utilisés dans la préparation de sous-couches, etc.

Das Ende des Produktlebenszyklus ist der Abbruch der Fliesen. Die Bruchstücke von dem Abbruch der Fliesen sind Abfälle von Keramikmaterialien, also von inerten Materialien (nicht reaktiv, chemisch und physikalisch stabil, widerstandsfähig auch gegen längeres Belichtung unter extremen thermischen Bedingungen).
Die Abbruchreste können ohne besondere Risiken in die Umwelt verbracht und auch zur Vorbereitung von Substraten usw. verwendet werden.

Consigli di posa Laying recommendations



Per il rivestimento di pavimenti e pareti mediante formati con lato superiore a 60 cm, Ceramica Rondine raccomanda di affidarsi al distanziatore livellante proposto da Raimondi: Levelling System e Andalsystem che consente facilmente di:

- Rendere perfettamente planare la superficie posata
- Mantenere la posizione desiderata di ogni piastrella
- Ridurre i tempi di posa

I distanziatori livellanti per piastrelle, rappresentano un sistema che permette di ottenere pavimenti livellati con semplicità e rapidità.

Guarda il video dimostrativo sul canale Youtube di Ceramica Rondine: www.youtube.com/user/Rondine-Group

For flooring and wall cladding using formats with sides of over 60 cm, Ceramica Rondine recommends the use of Raimondi levelling spacers: Levelling System and Andalsystem which make it easy for you to:

- Ensure that the laid surface is entirely flat
- Maintain the desired position for each tile
- Reduce laying time

Levelling spacers for tiles enable you to create level flooring in a quick and easy way.

Take a look at the video on the Ceramica Rondine Youtube channel: www.youtube.com/user/Rondine-Group

Pour le revêtement de sols et murs à l'aide d'un carrelage dont un côté dépasse les 60 cm, Ceramica Rondine conseille d'utiliser les cales de nivellement proposées par Raimondi: Levelling System et Andalsystem qui permettent facilement de:

- Nivelier parfaitement la surface posée
- Conserver l'emplacement souhaité pour chaque carreau
- Réduire le temps de pose

Les cales de nivellement pour carreaux permettent d'obtenir des sols nivelés en toute simplicité et avec rapidité.

Regardez la vidéo de démonstration sur la chaîne Youtube de Ceramica Rondine: www.youtube.com/user/RondineGroup

Zur Verkleidung von Fußböden und Wänden mit Formaten, deren obere Seite 60 cm misst, empfiehlt Ceramica Rondine die Nutzung von nivellierenden Abstandshaltern von Raimondi: Mit dem Levelling System und Andalsystem ist es möglich:

- die verlegte Oberfläche perfekt eben zu machen.
- die gewünschte Position jeder Fliese beizubehalten.
- die Verlegzeiten zu reduzieren.

Die nivellierenden Abstandshalter für Fliesen stellen ein einfaches und schnelles System dar, nivellierte Fußböden zu verlegen.

Sehen Sie sich das Demo-Video auf dem Youtube-Kanal von Ceramica Rondine an: www.youtube.com/user/RondineGroup

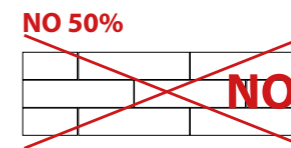

Per i formati rettangolari, si consiglia una sfalsatura tra ciascuna piastrella non superiore a 6-10 cm.
Fuga consigliata: minimo 3 mm. per prodotti non rettificati; minimo 2 mm. per prodotti rettificati.

When laying, you are recommended not to stagger the rectangular tiles by more than 6-10 cm (2"-4").
Suggested joint: 3 mm minimum for non-rectified products; 2 mm minimum for rectified products.

Pose conseillée avec un décalage entre chaque listel non supérieur à environ 6-10 cm.
Joint conseillée: 3 mm minimum pour produits non rectifiés; 2 mm minimum pour produits rectifiés.

Wir empfehlen eine Verlegung mit einer Verschiebung zwischen den einzelnen Leisten von nicht mehr als ungefähr 6-10 cm.
Empfohlene Fuge: mindestens 3 mm für nicht rechtwinklig geschliffene Produkte; mindestens 2 mm für rechtwinklig geschliffene Produkte.

CONSIGLI DI POSA E PULIZIA PER IL PRODOTTO CERAMICO DI CERAMICA RONDINE

Premessa

La norma UNI EN 14411 - “Piastrelle di ceramica - definizione, classificazione, caratteristiche e marcatura” - si propone di definire e fornire i termini, i requisiti ed i criteri di contrassegno per le piastrelle di ceramica di Prima scelta. Italcer S.p.A. sulle proprie piastrelle esegue costantemente tutti i test previsti dalla norma succitata, avvalendosi di laboratori accreditati. Vengono, inoltre, attuate costantemente procedure interne per il controllo della qualità del prodotto.

Posa

Il posatore sul cantiere prima della posa deve verificare il tono, il calibro, la scelta del materiale, mentre durante la posa deve prelevare sempre il materiale attingendo da più scatole per ottenere un mix cromatico ideale. Deve, altresì, verificare la congruità del prodotto anche per eventuali difetti già evidenti prima della posa, per i quali sono escluse le garanzie qualora la segnalazione avvenisse dopo la posa.

Il posatore deve utilizzare i collanti idonei per le varie destinazioni d’uso e seguire le indicazioni del produttore riportate sulle confezioni. Deve verificare attentamente che il sottofondo sia stabile, asciutto e maturo, non gelato e non eccessivamente caldo. Deve effettuare la spalmatura del collante a regola d’arte affinché non si creino vuoti tra piastrella e sottofondo.

Il posatore, in modo particolare per i prodotti con superfici levigate, satinate o lappate, deve stare attento a non segnare il materiale sulla superficie di utilizzo con matite (grafite) o pennarelli indelebili. Per realizzare i tagli e le sagomature richieste dalla Direzione dei Lavori, deve utilizzare appositi dischi diamantati e attrezzature specifiche, in particolar modo per il gres porcellanato. La dimensione della fuga tra le piastrelle può variare in funzione del formato che si utilizza, dell’angolazione della posa in ortogonale o in diagonale, e della destinazione d’uso. Si consiglia una fuga minima di 3 mm per i prodotti non rettificati e una fuga minima di 2 mm per i prodotti rettificati. La posa a correre dei formati rettangolari impone di sfalsare la piastrella di 6 cm e, comunque, mai più di 10 cm (Fig.1).

Negli ambienti di grande dimensione è necessario posizionare dei giunti di dilatazione con regolarità, mentre, per i piccoli ambienti è sufficiente lasciare un leggero stacco fra piastrellato e muri perimetrali, coperto poi dal battiscopa.

Stuccatura e pulizia dopo posa

L’utilizzo di malte o riempitivi colorati con pigmenti deve essere fatto dopo aver eseguito una prova preliminare.

Per le superfici levigate, satinate o lappate del gres porcellanato, a causa della microporosità provocata dall’azione abrasiva delle mole durante il processo di lavorazione, non si possono usare malte o riempitivi colorati a contrasto (piastrelle bianche e stuccatura antracite, rossa...).

Con l’utilizzo di stucchi cementizi dopo la stuccatura delle piastrelle, a stucco ancora fresco, è necessario rimuovere immediatamente, in modo accurato con spugna e abbondante acqua lo stucco in eccesso. Alcuni giorni dopo la posa, eseguire la pulizia di fondo mediante l’utilizzo di acidi tamponati al fine di sciogliere ed asportare completamente tutti i residui di cantiere.

Altrettanto importante è risciacquare bene fin quando l’acqua di lavaggio risulti essere limpida. Utile è l’utilizzo di aspiratori per liquidi, con lo scopo di rimuovere l’acqua sporca di lavaggio, evitando di spostarla da una parte all’altra. Anche a fine cantiere il posatore deve lavare i pavimenti con soluzioni di acqua e acido tamponato per evitare che la rimozione inadeguata o tardiva dei residui della stuccatura utilizzata per le fughe, lasci aloni difficili da rimuovere.

Per questa operazione Rondine propone Deterdek di FILA (attenersi rigorosamente alle percentuali di diluizione consigliate sul flacone), disincrostante acido che non sviluppa fumi nocivi e unisce all’azione disincrostante anche un’efficace azione pulente. Per particolari campi di applicazione, qualora si desideri ottenere una stuccatura impermeabile è possibile procedere con l’utilizzo di una malta epossidica. Seguire le precise indicazioni del produttore riportate sulle confezioni e attenersi rigorosamente alle modalità d’uso. Per l’impiego di tali prodotti, rivolgersi sempre a posatori esperti con alta professionalità poiché, la non corretta applicazione di stucchi epossidici, comprometterebbe in modo irreparabile l’aspetto estetico e cromatico delle piastrelle. Di recente FILA ha introdotto un innovativo pulitore per residui epossidici: FILACR10.

L’utilizzo di prodotti detergenti (tipo antiruggine) che spesso contengono acido fluoridrico danneggerebbe definitivamente la superficie di qualsiasi tipo di piastrella.

E’bene sapere, inoltre, che oltre il 90% delle contestazioni in cantiere è dovuto a un cattivo, o addirittura inesistente, lavaggio dopo posa. Con un corretto lavaggio dopo posa si eliminano i residui di posa (malta, colla, vernice, sporco da cantiere di varia natura) e si rimuovono eventuali residui superficiali di sporco.

Manutenzione ordinaria

Per i pavimenti con superficie levigata consigliamo di effettuare la pulizia giornaliera con il detergente neutro Fila Cleaner (attenersi rigorosamente alle percentuali di diluizione consigliate sul flacone) e di effettuare periodici trattamenti impregnanti antimacchia al fine di proteggerli da eventuali danni provocati da pennarelli, inchiostro, ruggine o altri prodotti ad altissima penetrabilità. Per quanto riguarda la manutenzione ordinaria delle nostre piastrelle, suggeriamo l’utilizzo dei prodotti di FILA. Per conoscerli consultare il sito www.filachim.com.

LAYING AND CLEANING RECOMMENDATIONS FOR CERAMICA RONDINE CERAMIC PRODUCTS

Introduction

Standard UNI EN 14411 – Ceramic tiles: Definition, Classification, Characteristics and Marking, defines and provides the marking terms, requirements and criteria for high quality ceramic tiles. Italcer S.p.A. continually tests all its tiles in accredited workshops, in accordance with the aforementioned standard. Moreover, internal quality control procedures are implemented on an ongoing basis.

Laying

Before laying at the site, the tiler should check the shade, size, and choice of material, whereas when laying the tiler should always use tiles from several boxes to obtain the ideal colour mix. The tiler should also check the product for any obvious flaws before laying, which would not be covered by the guarantee if pointed out after laying.

The tiler should use adhesives which are suitable for the various types of use, and follow the instructions on the packaging. The surface to be tiled should be checked to ensure it is stable, dry and ready for tiling, and is not excessively hot or cold. The adhesive should be applied professionally such that there are no gaps between the tile and the surface.

The tiler should be careful not to mark the material on the outer surface with pencils (graphite) or permanent markers, especially on products with smooth, glazed or lapped surfaces. Appropriate diamond tile cutters and special equipment should be used for the cutting and outlining operations requested by the Works Manager, especially with porcelain stoneware. The dimension of the tile joint may vary depending on the format used, orthogonal or diagonal laying angles, and final use. A minimum tile joint of 3 mm is recommended for non-rectified products and a minimum joint of 2 mm for rectified products. Laying rectangular formats in a staggered pattern requires tiles to be staggered by 6 cm, but never more than 10 cm. (Fig.1). In large rooms expansion joints must be positioned with regularity, whereas in small rooms it is sufficient to leave a slight gap between the tiles and perimeter walls, which are then covered with skirting.

Grouting and cleaning after laying

Fillers or mortar coloured with pigments should only be used after carrying out an initial test. For porcelain stoneware surfaces which are smooth, glazed or lapped, mortar or fillers which are contrast coloured (white tiles and anthracyte, red grouting etc.) cannot be used due to the microporosity caused by the abrasive action of the cutter during processing.

With the use of cement surfacers after grouting the tiles, with the grout still fresh, any excess grout should be removed immediately with a sponge and plenty water.

A few days after laying, clean thoroughly with buffered acids to completely remove and dissolve any residue. It is also important to rinse well until the wash water runs clean. Liquid extractors

are useful for removing dirty wash water, which avoids moving it from one place to another. When work has been completed the tiler should wash the floors with a water and buffered acid solution, to avoid the insufficient or late removal of grout residue leaving marks which may be difficult to remove.

Rondine recommends FILA Deterdek for this operation (follow the recommendations on the container for dilution percentages closely), which is an acid descaling agent that does not give off harmful fumes and combines the descaling action with effective cleaning.

For special areas of application, if waterproof grouting is required, epoxy mortar can be used. Follow the manufacturer’s instructions on the packaging exactly and adhere to the procedures for use. When using these products, always consult expert, qualified tilers, as the incorrect application of epoxy mortars could irreversibly compromise the colour and appearance of the tiles.

The use of detergents (anti-corrosive products) which contain hydrofluoric acid could permanently damage the surface of any type of tile. It should be noted that more than 90% of the problems which arise on site are due to incorrect, or even non-existent, washing after laying. Appropriate washing after laying removes laying residue (mortar, adhesive, various types of dirt from the work site) and any remaining surface dirt.

Standard maintenance

For floors with smooth surfaces we recommend cleaning daily with Fila Cleaner (adhere to the recommended dilution percentages on the container), and treat regularly with an anti-stain treatment to protect the tiles from damage caused by markers, ink, rust or other damaging products. We recommend the use of FILA products for the standard maintenance of Rondine tiles. For further information on these products visit www.filachim.com.are useful for removing dirty wash water, which avoids moving it from one place to another. When work has been completed the tiler should wash the floors with a water and buffered acid solution, to avoid the insufficient or late removal of grout residue leaving marks which may be difficult to remove.

Rondine recommends FILA Deterdek for this operation (follow the recommendations on the container for dilution percentages closely), which is an acid descaling agent that does not give off harmful fumes and combines the descaling action with effective cleaning.

For special areas of application, if waterproof grouting is required, epoxy mortar can be used. Follow the manufacturer’s instructions on the packaging exactly and adhere to the procedures for use. When using these products, always consult expert, qualified tilers, as the incorrect application of epoxy mortars could irreversibly compromise the colour and appearance of the tiles.

The use of detergents (anti-corrosive products) which contain hydrofluoric acid could permanently damage the surface of any type of tile. It should be noted that more than 90% of the problems which arise on site are due to incorrect, or even non-existent, washing after laying. Appropriate washing after laying removes laying residue (mortar, adhesive, various types of dirt from the work site) and any remaining surface dirt.

Standard maintenance

For floors with smooth surfaces we recommend cleaning daily with Fila Cleaner (adhere to the recommended dilution percentages on the container), and treat regularly with an anti-stain treatment to protect the tiles from damage caused by markers, ink, rust or other damaging products. We recommend the use of FILA products for the standard maintenance of Rondine tiles. For further information on these products visit www.filachim.com.

CONSEILS DE POSE ET DE NETTOYAGE POUR LES PRODUITS CÉRAMIQUES DE CERAMICA RONDINE

Préambule

La norme UNI EN 14411 - « Carreaux de céramique - définition, classification, caractéristiques et marquages » – entend définir et fournir les termes, les standards et les critères spécifiques aux carreaux de céramique de Premier choix.

Sur les carreaux qu'elle produit, la société Italcer S.p.A. effectue systématiquement tous les tests prévus par la norme susmentionnée, en faisant appel à cet effet à des laboratoires accrédités. Par ailleurs, sont constamment mises en oeuvre des procédures internes pour le contrôle de la qualité du produit.

Pose

Sur le chantier, avant la pose, le poseur doit contrôler la teinte, le calibre, le choix du matériau et durant la pose, il doit toujours prélever les carreaux dans plusieurs boîtes à la fois pour obtenir un mix chromatique idéal. Il doit par ailleurs s’assurer de la conformité du produit, entre autres au regard d’éventuels défauts visibles avant la pose, pour lesquels toute garantie est exclue dans le cas où la réclamation serait présentée après la pose.

Le poseur doit utiliser les colles appropriées en fonction du type d’utilisation prévu et doit suivre les recommandations du fabricant indiquées sur les emballages. Il doit effectuer un soigneux contrôle pour s’assurer que le support est stable et sec, non gelé et non excessivement chaud. Il doit étaler la colle dans les règles de l’art de façon à éviter la formation de vides entre le carreau et le support. En particulier pour les produits polis, satinés et adoucis, le poseur doit veiller à ne pas marquer le matériau sur la surface supérieure avec un crayon de papier (graphite) ou des feutres indélébiles. Pour réaliser les coupes et les profilages requis par la Direction des travaux, il doit utiliser des disques diamantés et des équipements spécifiques, en particulier pour le grès cérame. La largeur des joints entre les carreaux peut varier en fonction du format utilisé, de l’angle de pose (orthogonal ou diagonal) et de l’utilisation prévue. Il est recommandé de réaliser un joint d’au moins 3 mm pour les produits non rectifiés et d’au moins 2 mm pour les produits rectifiés. La pose à fond perdu des formats rectangulaires impose que les carreaux soient décalés d’au moins 6 cm et en aucun cas de plus de 10 cm (Fig. 1).

Dans les espaces de grandes dimensions, il est nécessaire de positionner des joints de dilatation avec régularité, alors que pour les espaces de petites dimensions, il suffit de maintenir un léger espace entre la surface carrelée et les murs de pourtour, qui sera ensuite recouvert par la plinthe.

Jointoiment et nettoyage après pose

L’utilisation de mortiers ou de produits de jointoiment colorés à l’aide de pigments doit s’effectuer à l’issue d’un essai préliminaire.

Pour les surfaces polies, satinées ou adoucies en grès cérame, en raison de la microporositè créée par l’action abrasive des meules durant le processus appliqué à la surface, il n’est pas possible d’utiliser des mortiers ni des produits de jointoiment colorés en contraste (carreau blanc et joint anthracite, rouge, etc.).

En cas d’utilisation de produits à base de ciment, après le jointoiment des carreaux, alors que le produit à joint est encore frais, il est nécessaire de retirer immédiatement et soigneusement, à l’aide d’une éponge et de beaucoup d’eau, l’excès de produit de jointoiment. Quelques jours après la pose, nettoyer à fond la surface en utilisant des acides tamponnés afin de dissoudre et d’éliminer totalement les résidus de chantier.

Il est tout aussi important de bien rincer jusqu’à ce que l’eau de lavage soit limpide. Il est utile d’utiliser un aspirateur à liquides pour éliminer l’eau sale de lavage, en évitant de la déplacer d’une partie à l’autre.

En fin de chantier également, le poseur doit laver les sols à l’aide d’une solution d’eau et d’acide tamponné pour éviter que la mauvaise élimination ou l’élimination tardive des résidus de produits de jointoiment ne laisse des auréoles dont il est ensuite difficile de venir à bout.

Pour cette opération, Rondine propose Deterdek de FILA (en veillant à respecter scrupuleusement les pourcentages de dilution recommandés sur le flacon), il s’agit d’un désincrustant acide qui ne dégage pas de fumées nocives et qui allie une action désincrustante à une action efficace de nettoyage. Pour certains champs d’application particuliers, dans le cas où l’on souhaiterait obtenir un jointoiment imperméable, il est possible de procéder à l’application d’un mortier époxy. Suivre les indications précises du fabricant figurant sur les emballages et veiller à respecter scrupuleusement les modalités d’utilisation. Pour l’utilisation de ces produits, veiller à toujours s’adresser à des poseurs hautement qualifiés dans la mesure où la mauvaise application de produits de jointoiment époxy peut compromettre l’aspect esthétique et chromatique des wcarreaux.

L’utilisation de produits détergents (de type antirouille) qui contiennent souvent de l’acide fluorhydrique a pour effet d’endommager définitivement la surface de tout type de carreau. Il convient par ailleurs de ne pas oublier que plus de 90 % des réclamations sur chantier sont dues à un mauvais lavage après pose voire à un lavage non effectué. Un bon lavage après pose permet d’éliminer les résidus de pose (mortier, colle, peinture et saletés de chantier de différentes natures) de même que les éventuels résidus de saletés superficielles.

Entretien courant

Pour les sols à surface polie, il est recommandé d'effectuer le nettoyage quotidien à l'aide du détergent neutre Fila Cleaner (en veillant à respecter scrupuleusement les pourcentages de dilution recommandés sur le flacon) et d'effectuer à intervalles réguliers des traitements imprégnants antitaches afin de les protéger contre les éventuels dommages causés par des feutres, de l'encre, de la rouille ou d'autres produits hautement pénétrants. Pour l'entretien courant des carreaux Rondine, nous conseillons l'utilisation des produits FILA. Pour les connaître, consulter le site www.filachim.com.

RATSCHLÄGE FÜR DAS VERLEGEN UND REINIGEN DES KERAMIKPRODUKTS VON CERAMICA RONDINE

Vorwort

Die Norm DIN EN 14411 – „Keramische Fliesen und Platten - Begriffe, Klassifizierung, Güteermale und Kennzeichnung“ – hat das Ziel, die Begriffe, Voraussetzungen und Kennzeichnungskriterien für keramische Fliesen erster Wahl festzulegen.

Italcer S.p.A. führt an seinen Fliesen ständig alle von der oben genannten Norm vorgesehenen Prüfungen durch, wobei die Dienste zugelassener Prüflabors in Anspruch genommen werden. Ferner werden durchgehend alle internen Prozeduren zur Qualitätssicherung des Produkts angewandt.

Verlegen

Der Fliesenleger muss auf der Baustelle vor dem Verlegen den Farbton, die Größe und die Wahl des Materials prüfen, während er das Material beim Verlegen immer abwechselnd mehreren Packungen entnehmen muss, um eine ideale Farbmischung zu erhalten. Der Fliesenleger muss ferner die Eignung des Produkts auch bezüglich eventueller bereits vor dem Verlegen sichtbarer Mängel prüfen, auf die nach dem Verlegen keine Garantie mehr geleistet wird.

Der Fliesenleger muss einen für die verschiedenen Bestimmungszwecke geeigneten Kleber verwenden und die auf den Packungen angegebenen Gebrauchsanweisungen des jeweiligen Herstellers beachten. Er muss sorgfältig kontrollieren, dass der Untergrund stabil, trocken und verlegereif, nicht gefroren und nicht zu warm ist. Der Kleber ist kunstgerecht zu verteilen, damit sich keine Hohlräume zwischen Fliese und Untergrund bilden.

Der Fliesenleger muss insbesondere bei Produkten mit polierter, satinierter oder geläppter Oberfläche darauf achten, das Material auf der nach oben weisenden Seite nicht mit einem Bleistift (Graphit) oder unutilisierter Tinte zu kennzeichnen. Bei der Realisierung der von der Bauleitung geforderten Zuschnitte und Formen sind spezielle Diamantscheiben und spezifische Werkzeuge zu verwenden. Das gilt insbesondere für emailliertes Steinzeug.

Die Größe der Fugen zwischen den einzelnen Fliesen kann je nach verwendetem Format, Verlegewinkel (orthogonal oder diagonal) und Bestimmungszweck variieren. Für nicht rechtwinklig geschliffene Produkte wird eine Mindestfuge von 3 mm, für rechtwinklig geschliffene Produkte von 2 mm empfohlen.

Die fortlaufende Verlegung rechteckiger Formate erfordert das Versetzen der Fliese um 6 cm, aber auf keinen Fall um mehr als 10 cm. (Abb.1).

In großen Räumlichkeiten müssen in regelmäßigem Abstand Dehnungsfugen vorgesehen werden, während in kleinen Räumen ein kleiner Freiraum zwischen Fliesen und Wänden ausreicht, der dann durch die Fußleiste abgedeckt wird.

Ausfugen und Reinigen nach dem Verlegen

Vor dem Gebrauch von mit Pigmenten gefärbten Mörteln oder Füllstoffen sollte eine entsprechende Probe durchgeführt werden.

Für polierte, satinierte oder geläppte Oberflächen emaillierten Steinzeugs können aufgrund der durch die Schleifwirkung der Schleifscheiben während des Bearbeitungsprozesses verursachten Mikroporosität keine kontrastgefärbten Mörtel oder Füllstoffe verwendet werden (weiße Fliesen und Ausfugmaterial in Anthrazit, Rot usw.).

Beim Gebrauch von Zementmörteln nach dem Ausfugen der Fliesen ist es bei noch frischem Mörtel erforderlich, den überschüssigen Mörtel umgehend mit einem Schwamm und reichlich Wasser zu entfernen. Einige Tage nach dem Verlegen wird eine gründliche Reinigung mit gepufferten Säuren durchgeführt, um alle Rückstände zu lösen und vollständig zu entfernen.

Ebenso wichtig ist ein gründliches Nachspülen, bis das Reinigungswasser klar ist. Nützlich ist die Anwendung von Flüssigkeitsabsaugern, um das schmutzige Reinigungswasser zu entfernen, ohne es über die Fliesen zu schieben.

Auch nach Abschluss aller Bauarbeiten muss der Fliesenleger die Böden mit einer Lösung aus Wasser und gepufferter Säure waschen, um zu verhindern, dass ein unsachgemäßes oder zu spätes Entfernen der Rückstände des für die Fugen verwendeten Mörtels schwer zu entfernende Schleier hinterlässt.

Für diese Reinigungsarbeiten empfiehlt Rondine das Produkt Deterdek von FILA (den vom Hersteller auf der Flasche angegebenen Verdünnungsgrad strikt beachten), einen sauren Kraftreiniger, der keine schädlichen Dämpfe bildet und gleichzeitig auch eine sehr gute Reinigungswirkung besitzt. Für besondere Anwendungen, wenn zum Beispiel eine wasserundurchlässige Ausfugung gewünscht wird, kann ein Epoxidmörtel verwendet werden. Die Gebrauchsanweisung des Herstellers auf den Packungen genau befolgen. Für den Gebrauch solcher Produkte sollte man sich immer an Fliesenleger mit großer Berufserfahrung wenden, denn die falsche Aufbringung von Epoxidmörteln führt zu einer irreparablen Beeinträchtigung der Ästhetik und der Farbe der Fliesen.

Der Gebrauch von Reinigungsmitteln (des Typs Rostschutzmittel), die oft Fluorsäure enthalten, führt zu einer irreparablen Beschädigung der Oberfläche aller Fliesenarten. Ferner sollte man wissen, dass über 90% der Beanstandungen auf der Baustelle auf ein ungenügendes oder gar fehlendes Waschen nach den Verlegearbeiten zurückzuführen sind.

Durch das korrekte Waschen nach dem Verlegen werden Verlegungsrückstände (Mörtel, Kleber, Lack, Baustellenschmutz unterschiedlicher Art) eliminiert und eventuelle oberflächliche Schmutzablagerungen entfernt.

Instandhaltung und Pflege

Für Böden mit polierter Oberfläche empfehlen wir eine tägliche Reinigung mit dem neutralen Reiniger Fila Cleaner (den auf der Flasche angegebenen Verdünnungsgrad strikt beachten) und eine regelmäßige Behandlung mit Imprägniermitteln zum Schutz gegen Flecken und Verunreinigungen durch Stifte, Tinte, Rost oder anderen Stoffen mit hohem Penetrationsvermögen. Für die Instandhaltung und Pflege unserer Fliesen empfehlen wir die Produkte von FILA. Diese Produkte finden Sie auf der Internetseite www.filachim.com.

Legenda Legend



Piastrelle indicate per pavimenti
Tiles specifically used for floors
Carreaux pour carrelages de sol
Bodenfliesen



Piastrelle indicate per rivestimenti interni
Tiles specifically used for wall coverings
Carreaux pour faïences
Wandfliesen für den Innenbereich



Piastrelle indicate per abitazioni residenziali
Tiles for dwelling houses
Carreaux pour habitations résidentielles
Fliesen für den Wohnbereich



Piastrelle particolarmente indicate per l'esterno
Tiles especially suitable for outdoor applications
Carreaux particulièrement indiqués pour application à l'extérieur
Besonders für Aussenbereiche geeignete Fliesen



Piastrelle indicate per luoghi pubblici a traffico leggero
Tiles suitable for low traffic public and commercial areas
Carreaux recommandés pour lieux publics et commerciaux à piétinement léger
Für Bodenbeläge in Bereichen mit gewöhnlicher Begehungsfrequenz und Schleifschmutz



Piastrelle indicate per luoghi pubblici a traffico pesante
Tiles suitable for heavy traffic public and commercial areas
Carreaux recommandés pour lieux publics et commerciaux à piétinement lourd
Fliesen für Bereiche, die starker Begehung ausgesetzt sind



*** Produzione Speciale: questi articoli necessitano di una quantità minima e sono prodotti in 3/4 settimane.**
Special Production: a minimum quantity is required for the order of special trims on request. pieces will be produced in 3/4 weeks.
Production Spéciale: les pièces spéciales sur demande comportent une qualité minimum obligatoire. elles sont produites dans un délai de 3/4 semaines.
Sonderfertigung: die nach wunsch gefertigten formteile benötigen eine mindestqualität und werden in 3-4 wochen.

* Tutti i pezzi speciali e decori sono acquistabili solo a confezioni intere - All special trims and decors can be purchased as a whole - Achat des pieces speciales seulement par boites completes - Las piezas especiales y las decoraciones podrán adquirirse sólo en cajas enteras. - Formstuecke und Dekore werden nur in vollen Kartons geliefert

Indice di variazione Variation index



Piastrella uniforme
Tiles with uniform appearance
Carreaux avec une apparence uniforme
Einheitliche fliese



Piastrella con leggera variazione di tono e grafica
Tiles with slight shade and graphic variation
Carreaux avec faible différence de nuance et structure
Fliese mit einer leichten Abänderung des tons und grafik

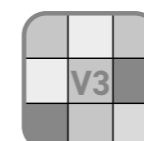

Piastrella con discreta variazione di tono e grafica
Tiles with moderate shade and graphic variation
Carreaux avec moderate différence de nuance et structure
Fliese mit einer moderat Abänderung des tons und grafik



Piastrella con notevole variazione di tono e grafica
Tiles with huge variation of shade and graphic
Carreaux avec une considerable difference de nuance et structure
Fliese mit einer beträchtlich Abänderung des tons und der grafik.

CONDIZIONI GENERALI DI VENDITA

Italcer S.p.A. si riserva il diritto di modificare in qualunque momento le informazioni e le caratteristiche tecniche contenute nel presente catalogo (“Catalogo”) e nel sito web (incluso tutti i documenti e cataloghi scaricabili via internet), che non sono da ritenersi legalmente vincolanti. Pesi, colori e misure possono subire variazioni tipiche del particolare processo di produzione del materiale ceramico. I colori e le caratteristiche estetiche dei prodotti sono quanto più possibile vicini a quelli reali, nei limiti consentiti dai processi di riproduzione virtuale. Italcer S.p.A. considera le informazioni e le specifiche tecniche di cui al presente Catalogo corrette e precise; tuttavia non esclude la presenza di errori materiali ed invita i compratori (“Compratori”) a verificare le informazioni e le specifiche tecniche con gli agenti / commerciali di riferimento.

©2020 Italcer S.p.A. Tutti i diritti sono riservati. Ogni riproduzione totale e/o parziale dei contenuti del presente Catalogo, sia di testo che di immagine, è vietata e sarà perseguita nei termini di legge.

- PRODOTTO E GARANZIA:
 - Le elevate temperature di cottura del gres ceramico, possono provocare differenze di tono e di calibro. Sono perciò ammesse ed accettate dal Compratore delle differenze nelle dimensioni indicate, che però non superino i limiti di tolleranza prevista dalle norme UNI-EN-ISO 14411.
 - Italcer S.p.A. garantisce i prodotti come conformi alle norme UNI-EN-ISO 14411 attualmente in vigore. La garanzia è limitata esclusivamente ai materiali di 1^ scelta. I materiali di 2^ e di 3^ scelta e le partite occasionali si intendono venduti come “visti e piaciuti, non contestabili”.
 - Le colorazioni dei materiali presentati in campionature sono da considerarsi puramente indicative. Eventuali variazioni di colore o di tonalità sono giustificate dalla natura stessa del materiale, dalle caratteristiche dei cicli di produzione e dalle materie prime impiegate. Si consiglia pertanto di miscelare il materiale, prelevandolo da diverse scatole, e di pesare il materiale con una fuga distanziatrice.
 - Decorì e pezzi speciali sono forniti in tonalità differenziate dal fondo.
 - Italcer S.p.A. risponde solo ed esclusivamente della levigatura e della lucidatura effettuata nei propri stabilimenti.
 - La garanzia comprende unicamente la sostituzione del materiale non posato riscontrato difettoso con esclusione di ogni ulteriore e diverse pretese.
- ORDINI:
 - Ogni ordine trasmesso a Italcer S.p.A. dal Compratore, dagli agenti rappresentanti, od incaricati è da intendersi accettato sempre salvo approvazione della direzione di Italcer S.p.A. stessa.
 - Tutte le ordinazioni, anche verbali, salvo accordi contrari scritti, si intendono sempre accettate da Italcer S.p.A. alle presenti condizioni generali, senza bisogno di richiamarle. In assenza di precise eccezioni scritte, si intende che il Compratore accetta integralmente le condizioni particolari e generali di vendita.
- PREZZI:
 - I prezzi si intendono per merce resa franco stabilimento di produzione, IVA esclusa.
 - Palette tipo EURO saranno addebitate al costo di euro 10,00/cad., nel caso di mancato scambio al momento del carico.
- CONSEGNA:
 - I termini di consegna concordati con Italcer S.p.A. sono da intendersi puramente indicativi. Qualora si verificino cause di forza maggiore, Italcer S.p.A. può recedere in parte o in toto dal contratto di vendita.
 - I ritardi nella consegna non danno mai, al Compratore, il diritto di annullare il contratto, né di pretendere il risarcimento di eventuali danni diretti o indiretti.
 - La merce viaggia sempre e comunque a rischio e pericolo del compratore. La merce si intende acquistata dal Compratore franco stabilimento di produzione, anche quando il prezzo fosse franco destino. Ogni responsabilità di Italcer S.p.A. cessa a carico compiuto, e non si risponde di eventuali rotture, manomissioni ed ammanchi.
 - Quando le merci pronte per la spedizione rimangono, per richiesta del Compratore, presso gli stabilimenti di Italcer S.p.A., la fattura viene emessa come se la spedizione fosse avvenuta ed i materiali vengono tenuti in magazzino a rischio, pericolo e spese del Compratore.
- PAGAMENTO:
 - I pagamenti devono essere effettuati direttamente a Italcer S.p.A. nella sede di Rubiera (RE). La merce resta di proprietà di Italcer S.p.A. sino al momento del completo pagamento del prezzo concordato.
 - Nel caso di ritardo nel pagamento totale ed anche parziale di una fattura, Italcer S.p.A. salvi tutti gli altri suoi diritti, avrà facoltà di sospendere le ulteriori consegne, anche se queste fossero dovute in dipendenza di altri contratti, di spiccare tratte per l’ammontare delle fatture scadute, ed anche di pretendere l’immediato e intero pagamento di tutto il materiale ordinato, o di averlo in altro modo garantito.
 - In caso di ritardato pagamento verranno addebitati al Compratore interessi e oneri bancari ai tassi correnti del periodo di mora. Per tutto quanto non previsto nelle clauseole suindicatè, si rimanda alla legge italiana ed agli usi vigenti.
- RECLAMI:
 - Non si accettano reclami per i materiali già posati in opera. Reclami per vizi e difetti del materiale devono essere denunciati e comunicati nei termini previsti dalla legge. In ogni caso di accettazione del reclamo il Compratore dovrà restituire il materia-le oggetto di contestazione che verrà sostituito da Italcer S.p.A. con fornitura equivalente. Tale sostituzione annulla il diritto del Compratore di chiedere la risoluzione del contratto o la riduzione del prezzo o il risarcimento di eventuali danni.
 - Qualsiasi reclamo o contestazione non implica la sospensione ed il rifiuto al pagamento delle fatture. Il pagamento dovrà effettuarsi regolarmente ed integralmente nei termini convenuti.
 - Non si accettano resi di merce se non autorizzati per iscritto da Italcer S.p.A.
- FORO COMPETENTE:

Per qualsiasi controversia il Foro competente è quello di Reggio Emilia (Italia). Tuttavia Italcer S.p.A. si riserva il diritto di agire presso il foro competente della sede del Compratore per azioni volte al recupero del credito. In tal caso troverà applicazione la legge locale.

GENERAL SALES CONDITIONS

Italcer S.p.A. reserves the right to change the information and technical specifications contained in this catalogue (“Catalogue”) and on the website at any time (including all downloadable documents and catalogues) which are not considered legally binding. Weights, colours and measurements may vary due to the ceramic production process. The colours and aesthetic characteristics of products are as near as possible to actual colours and characteristics, within the limits of the virtual reproduction process. Italcer S.p.A. deems the information and technical specifications contained in this Catalogue to be correct and accurate; notwithstanding the presence of material errors is not excluded and the purchasers (“Purchasers”) are invited to verify the information and technical specifications with their agents and area managers.

©2020 Italcer S.p.A. All rights reserved. Any reproduction, whether total or partial, of the content of this Catalogue, whether text or image, is forbidden and will be prosecuted under the law.

- PRODUCT AND WARRANTY:
 - The high temperatures used to fire ceramic stoneware can cause differences in shade and work size. Variations in the dimensions indicated shall therefore be accepted by the Purchaser, provided they are within the limits set by the UNI-EN-ISO 14411 standards.
 - Italcer S.p.A. guarantees that products are compliant with current UNI-EN-ISO 14411 standards. This warranty applies to best-quality materials only; second- and third-class materials and one-off batches shall be sold “as seen and accepted” and may not be the object of claims.
 - The colouring of the sample materials presented is to be considered merely indicative. Any variations in colour or shade are due to the particular nature of the material, the characteristics of the production cycle and the raw materials used. It is therefore advisable to mix the tiles by taking them from different boxes, and separate them with a joint when laying.
 - Decorations and special trims are supplied in a different shade from the base tiles.
 - Italcer S.p.A. shall be held responsible only for the smoothing and polishing processes carried out in its own factories.
 - The warranty covers only the replacement of material found to be faulty, before laying. No other claims will be taken into consideration.
- ORDERS:
 - All orders transmitted to Italcer S.p.A. by the Purchaser, by the sales agents or similar shall be deemed to have been accepted, subject to approval on the part of the management of Italcer S.p.A.
 - All orders, including verbal orders, provided there are no written agreements to the contrary, shall be presumed to have been accepted by Italcer S.p.A. under the general sales conditions herein, without the need to expressly make reference to such conditions. Provided there are no precise written agreements to the contrary, the Purchaser is presumed to have accepted the general and specific sales conditions in full.
- PRICES:
 - Prices are quoted EXW, exclusive of VAT.
 - EURO type pallets will be charged at a cost of €10.00 each, in the event that the purchaser fails to provide their own for loading.
- DELIVERY:
 - The delivery terms arranged with Italcer S.p.A. are to be considered merely indicative. In the event of force majeure, Italcer S.p.A. may terminate the sales contract, either completely or partially.
 - Delays in delivery do not entitle the Purchaser to terminate the contract, or to claim for any direct or indirect damages deriving from delay.
 - Goods travel at the risk and responsibility of the Purchaser at all times. Goods are understood to be bought by the Purchaser EXW, even if the price is carriage paid. Italcer S.p.A.’s responsibility ends when the goods have been loaded, and Italcer S.p.A. may not be held responsible for any breakages, tampering or pilfering.
 - When goods ready for delivery remain at Italcer S.p.A.’s premises at the request of the Purchaser, the invoice shall be issued as if delivery had already taken place, and the materials shall be held in the warehouse at the risk, responsibility and expense of the Purchaser.
- PAYMENT:
 - Payments must be made directly to Italcer S.p.A. at its headquarters in Rubiera (Reggio Emilia). The goods shall remain the property of Italcer S.p.A. until the price agreed upon has been paid in full.
 - In the event of a delay in payment of an invoice or part thereof, Italcer S.p.A., all other rights reserved, shall be entitled to: place any further deliveries on hold, even in the event that such deliveries are due depending on other contracts; to draw a bill of exchange for the amount of the invoices overdue, and to demand full, immediate payment for all the material ordered, or to have such payment guaranteed by alternative means.
 - In the event of delays in payment, interests and bank charges will be charged to the Purchaser at the rates applicable for the period corresponding to the delay. For all and any matters not expressly provided for in the clauses above, the Italian laws and current commercial practice shall apply.
- CLAIMS:
 - Claims will not be accepted for materials that have already been laid. Claims for faults and defects must be reported within the terms provided for by law. For all claims accepted, the Purchaser must return the material concerned, which will be replaced by Italcer S.p.A. with an equivalent supply. Where such equivalent materials have been supplied, the Purchaser is not entitled to request the termination of the contract, nor the reduction in price or the compensation of damages of any kind.
 - Any claims made do not entitle the Purchaser to suspend or refuse payment of the invoices. Payments due must be regularly made in full and in accordance with the terms agreed.
 - Returns will not be accepted without the written authorization of the manufacturer.
- COMPETENT COURT:

For any disputes that may arise, the competent court is that of Reggio Emilia (Italy). As an exception to the above, Italcer S.p.A. reserves the right, for disputes related to credit recovery, to bring action before the competent court of the place where the Purchaser has its registered seat; in such case the Laws of such local court shall apply.

CONDITIONS GÉNÉRALES DE VENTE

Italcer S.p.A. se réserve la faculté de modifier à tout moment les informations et les caractéristiques techniques figurant sur le catalogue (« Catalogue ») et le site Internet (y compris les documents et catalogues téléchargeables via Internet), ce–qui légalèment n’engage pas Italcer S.p.A. Poids, couleurs et dimensions peuvent subir des variations au processus de production propres du matériel céramique. Les couleurs et les caractéristiques esthétiques des produits sont les plus proches possibles des couleurs et des caractéristiques réelles, dans les limites des moyens de reproduction virtuelle. Italcer S.p.A. considère les informations et les caractéristiques techniques figurant sur le Catalogue exactes et précises ; cependant Italcer S.p.A. n’exclut pas la présence d’erreurs matérielles et demande aux acheteurs (« Acheteurs ») de vérifier les informations et les caractéristiques techniques avec les commerciaux et/ou représentants.

©2020 Italcer S.p.A. Tous les droits sont réservés. Toute reproduction totale ou partielles des contenus du présent Catalogue, textes et images, est interdite et sera poursuivie en termes de droit,

- PRODUIT ET GARANTIE :
 - Les hautes températures de cuisson du grès cérame peuvent occasionner des différences de tonalité et de calibre. L’Acheteur déclare donc admettre et accepter les écarts de dimensions mentionnés qui, en tout état de cause, devront respecter les limites de tolérance posées par les normes UNI-EN-ISO 14411.
 - Italcer S.p.A. s’engage à fournir des produits conformes aux normes UNI-EN-ISO 14411 en vigueur. La garantie ne couvre que les matériaux de premier choix. Les matériaux de deuxième et troisième choix et les occasions sont vendus « en l’état », sans possibilité de contestations.
 - Les couleurs des échantillons fournis ne sont données qu’à titre purement indicatif. Toute variation de nuance ou tonalité est justifiée par la nature du matériau, par les caractéristiques des cycles de production et par les matières premières employées. Par conséquent, il est recommandé de mélanger les carreaux des différentes boîtes et de les poser avec un joint d’écartement.
 - Les décors et les pièces spéciales sont livrés dans une autre tonalité que le fond.
 - Italcer S.p.A. n’est responsable que des opérations de douçissage et de polissage effectuées dans ses usines.
 - La garantie ne couvre que le remplacement du matériau non posé réputé défectueux, à l’exclusion de toute autre indemnité.
- COMMANDES :
 - Les commandes envoyées à Italcer S.p.A.par l’Acheteur, par les commerciaux oules représentants, ne sont réputées définitives qu’après acceptation par la direction de Italcer S.p.A.
 - Sauf accords écrits contraires, toutes les commandes, y compris verbales, sont toujours considérées comme acceptées par Italcer S.p.A. aux présentes conditions générales, sans nul besoin de les rappeler. À défaut d’exceptions précises par écrit, l’Acheteur accepte l’intégralité des conditions générales et particulières de vente.
- PRIX :
 - Les prix sont exprimés départ usine, hors TVA.
 - Les europalettes non rendues lors du chargement seront facturées à 10,00 €/pièce.
- LIVRAISON :
 - Les délais de livraison fixés avec Italcer S.p.A. ne sont donnés qu’à titre purement indicatif. En cas de force majeure, Italcer S.p.A. peut résilier le contrat de vente en tout ou partie.
 - Les retards de livraison ne donnent jamais droit à l’Acheteur de résilier le contrat, ni de prétendre à des indemnités pour les dommages directs et indirects.
 - La marchandise voyage toujours aux risques et périls de l’Acheteur. La marchandise est réputée achetée départ usine, même si le prix est formulé port payé jusqu’au lieu de destination convenu. La responsabilité de Italcer S.p.A. cesse à la fin du chargement. Dès lors, Italcer S.p.A. ne saurait être tenue pour responsable des dégâts, des altérations et des pertes.
- Lorsque la marchandise prête pour l’expédition reste dans les établissements de Italcer S.p.A. à la demande de l’Acheteur, la facture est émise comme si l’expédition avait eu lieu. Les matériaux sont alors stockés aux risques, périls et frais de l’Acheteur.
- PAIEMENT :
 - Les paiements doivent être faits directement à l’adresse de Italcer S.p.A., à Rubiera (RE). La marchandise reste la propriété de Italcer S.p.A. jusqu’au paiement intégral du prix établi.
 - En cas de retard dans le paiement de tout ou partie d’une facture, Italcer S.p.A. aura la faculté d’interrompre, sans préjudice de tous ses autres droits, les autres livraisons, même des livraisons relatives à d’autres contrats, de tirer des traites pour le montant des factures échues, d’exiger le paiement immédiat et intégral de toute la marchandise commandée ou une autre forme de garantie.
 - Tout retard de paiement entraînera pour l’Acheteur des intérêts et des charges bancaires aux taux en vigueur. Pour tout autre point non expressément prévu par les clauses susvisées, les parties s’accordent à appliquer la loi italienne et les normes en vigueur.
- RECLAMATIONS :
 - Nous n’admettons aucune réclamation sur les produits déjà posés. Les vices et défauts du matériau doivent être dénoncés et communiqués dans les délais de loi. Dans la mesure où la réclamation est acceptée, l’Acheteur devra rendre le matériau objet de contestation pour permettre au Italcer S.p.A. de le remplacer par un lot du même type. Ce remplacement annule le droit de l’Acheteur de demander la résiliation du contrat, une remise sur le prix ou un dédommagement.
 - Toute réclamation ou contestation n’implique ni l’interruption ni le refus de paiement des factures. Le paiement devra être régulier, intégral et conforme aux conditions établies.
 - Aucun retour de marchandises ne sera accepté sans l’accord écrit de Italcer S.p.A.
- TRIBUNAL COMPÉTENT :

Tout litige sera du ressort du Tribunal de Reggio Emilia (Italie). Cependant Italcer S.p.A. se réserve le droit d’agir auprès du Tribunal de compétence du siège social de l’Acheteur pour le recouvrement de la créance. Dans ce cas, la loi locale s’applique.

ALLGEMEINE GESCHÄFTSBEDINGUNGEN

Italcer S.p.A. behält sich das Recht vor, jederzeit die in diesem Katalog („Katalog“) enthaltenen Informationen und technischen Merkmale zu ändern die als nicht gesetzlich verbindlich zu betrachten sind. Gewicht, Farben und Abmessungen können infolge des besonderen Produktionsprozesses von Keramikprodukten typische Veränderungen aufweisen. Die Farben und ästhetischen Eigenschaften der Produkte entsprechen innerhalb der Grenzen der virtuellen Reproduktionsverfahren so weit wie möglich den effektiven Eigenschaften des Produkts. Italcer S.p.A. erachtet die in diesem Katalog genannten Informationen und technischen Spezifikationen als richtig und genau; Dies schließt jedoch das Vorhandensein von Materialfehlern nicht aus und fordert die Käufer (“Käufer“) auf, die Informationen und technischen Spezifikationen bei den Referenzagenten / der Werbung zu überprüfen.

©2020 Italcer S.p.A. Alle Rechte vorbehalten. Der vollständige oder auszugsweise Nachdruck des Inhalts dieses Katalogs in Schrift und Bild ist verboten und wird nach Maßgabe des Gesetzes geahndet.

- PRODUKTGEWÄHRLEISTUNG:
 - Die hohen beim Brennvorgang zum Einsatz kommenden Temperaturen können Unterschiede beim Farbton und Werkmaß verursachen. Abweichungen von den angegebenen Maßen sind daher vom Käufer zu akzeptieren, die von der Norm UNI-EN-ISO 14411 festgelegten Toleranzen dürfen dabei jedoch nicht überschritten werden.
 - Italcer S.p.A. garantiert, dass die Produkte die derzeit geltenden UNI-EN und ISO-Normen erfüllen. Die Garantie wird ausschließlich auf Material erster Wahl beschränkt. Die Materialien zweiter und dritter Wahl und Sonderposten verstehen sich verkauft „wie gesehen“ und können nicht reklamiert werden.
 - Die Farbtonè der als Muster präsentierten Materialien sind nur zur Orientierung gedacht. Eventuelle Abweichungen bei Farbe und Farbton gehen auf die Natur des Materials, die Merkmale des Produktionsverfahrens und die verwendeten Rohstoffe zurück. Daher wird empfohlen die Fliesen zu mischen, indem sie verschiedenen Schachteln entnommen werden, und das Material mit einer Abstandsfulge zu verlegen.
 - Dekore und Formteile werden in Farbtonen angeboten, die sich von den Grundfliesen unterscheiden.
 - Italcer S.p.A. ist nur für das im eigenen Werk erfolgte Polieren und Glanzpolieren haftbar.
 - Die Garantie umfasst nur den Ersatz des nicht verlegten, fehlerhaften Materials, sonstige Ansprüche sind ausgeschlossen.
- BESTELLUNGEN:
 - Jede Bestellung, die von Italcer S.p.A., von den Handelsvertretern oder den Bevollmächtigten an den Verkäufer übermittelt wird, versteht sich als akzeptiert, dabei wird stets vorausgesetzt, dass die Genehmigung durch Italcer S.p.A. selbst erfolgt.
 - Alle Bestellungen, auch solche mündlicher Art, wenn nicht schriftlich eine abweichende Vereinbarung erfolgte, verstehen sich stets von Italcer S.p.A. als zu den allgemeinen Geschäftsbedingungen akzeptiert, ohne dass eine Erinnerung erfolgen muss. Wenn keine genauen schriftlichen Ausnahmen vereinbart wurden, versteht es sich, dass der Käufer umfassend die allgemeinen Geschäftsbedingungen akzeptiert.
- PREISE:
 - Die Preise verstehen sich für Waren ab Herstellungswerk, zuzügl. Mehrwertsteuer.
 - EURO-Paletten werden zum Preis von 10,00 EUR/Stück berechnet, falls bei der Beladung kein Austausch erfolgt.
- LIEFERUNG:
 - Die mit Italcer S.p.A. vereinbarten Lieferbedingungen dienen nur zur Orientierung. Bei Fällen Höherer Gewalt, kann Italcer S.p.A. ganz oder zum Teil vom Kaufvertrag zurücktreten.
 - Lieferverspätungen geben dem Käufer in keinem Fall das Recht, vom Vertrag zurückzutreten oder einen Schadensersatz für eventuelle mittelbare oder unmittelbare Schäden zu verlangen.
 - Die Ware wird stets auf Risiko des Käufers transportiert. Die Ware versteht sich vom Käufer als ab Werk erworben, auch wenn der Preis sich frei Bestimmungsort versteht. Jede Haftung von Italcer S.p.A. endet nach der erfolgten Beladung, der Verkäu-fer haftet nicht für einen eventuellen Bruch, die Manipulation und das Fehlen von Material.
 - Wenn die bereits lieferfertige Ware auf Wunsch des Käufers im Werk von Italcer S.p.A. verbleibt, wird die Rechnung ausgestellt, als ob die Fracht erfolgt wäre und die Materialien werden auf Gefahr, Risiko und Kosten des Käufers im Lager aufbewahrt.
- ZAHLUNGSBEDINGUNGEN:
 - Die Zahlungen müssen direkt an Italcer S.p.A. an den Firmensitz in Rubiera (RE) erfolgen. Die Waren bleiben Eigentum von Italcer S.p.A., bis die vollständige Zahlung des vereinbarten Preises erfolgt ist.
 - Sollte die Gesamt- oder Teilzahlung einer Rechnung verspätet erfolgen, ist Italcer S.p.A., vorbehaltlich anderer Ansprüche, berechtigt, weitere Lieferungen einzustellen, auch wenn diese sich auf andere Verträge beziehen, Wechsel auf den Betrag der fälligen Rechnungen auszustellen und auch die sofortige und gesamte Zahlung des gesamten bestellten Materials zu verlangen, oder eine anderweitige Garantie zu erhalten.
- Bei einer Zahlungsverzögerung werden dem Käufer Verzugszinsen und Bankgebühren zu den aktuellen Tarifen in Rechnung gestellt. Für alles, was in den obigen Klauseln nicht vorgesehen ist, wird auf das Italienische Recht und üblichen Gepflogenheiten verwiesen.
- REKLAMATIONEN:
 - Es werden keine Reklamationen für bereits verlegte Fliesen akzeptiert. Reklamationen für Materialmängel und –fehler müssen im Rahmen der gesetzlichen Bestimmungen mitgeteilt werden. Wird eine Reklamation genehmigt, muss der Käufer das Material, das Gegenstand der Beanstandung ist, zurücksenden. Dieses wird von Italcer S.p.A. durch eine entsprechende gleichwertige Lieferung ersetzt. Der Ersatz des Materials macht das Recht des Käufers auf eine Auflösung des Vertrags oder eine Preisermäßigung, bzw. einen Schadensersatz unwirksam.
 - Keine Reklamation oder Beanstandung rechtfertigt eine Zahlungseinstellung oder eine Verweigerung, die Rechnungen zu zahlen. Die Zahlung hat ordnungsgemäß und vollständig zu den vereinbarten Bedingungen zu erfolgen.
 - Warenrückgaben werden nicht akzeptiert, wenn diese nicht vorher schriftlich von Italcer S.p.A. genehmigt wurden.
- GERICHTSSTAND:

Gerichtsstand für alle Streitigkeiten ist Reggio Emilia (Italien). Italcer S.p.A. behält sich das Recht vor, bei dem zuständigen Gericht am Sitz des Käufers Klage auf Rückforderung von Krediten zu erheben. In diesem Fall gilt das örtliche Recht.

Schemi di posa Laying sketch - Schémas de pose - Modulverlegungsbeispiele

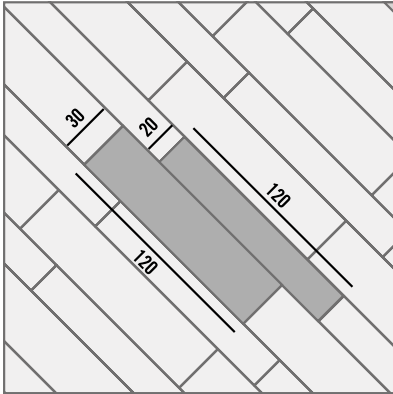

20x120 40%
30x120 60%

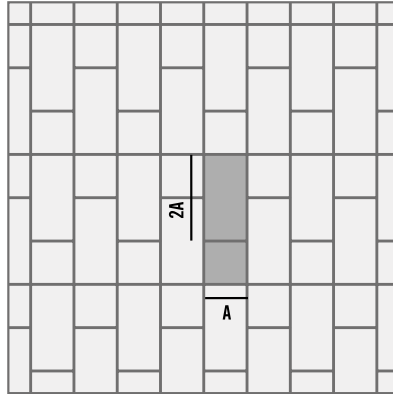

Ax2A 67%
AxA 33%

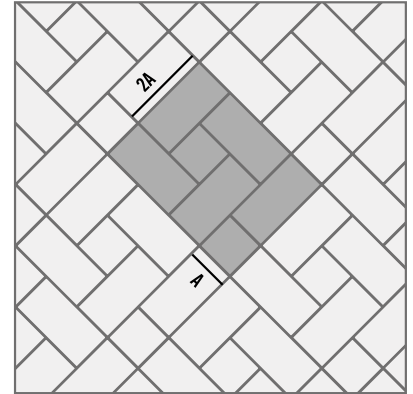

Ax2A 83%
AxA 17%

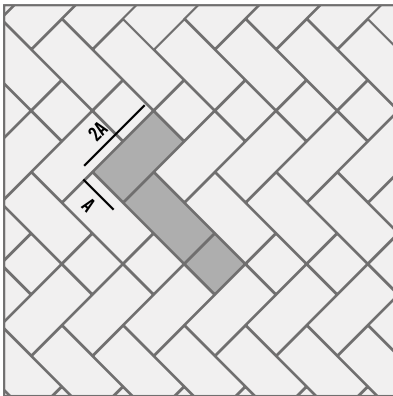

Ax2A 80%
AxA 20%

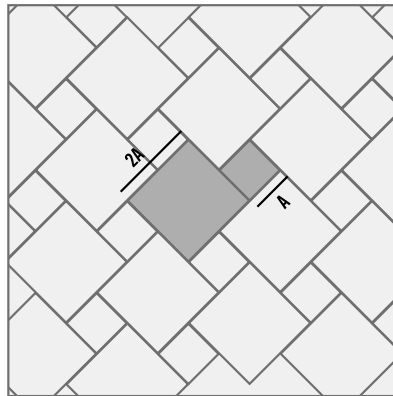

2Ax2A 80%
AxA 20%

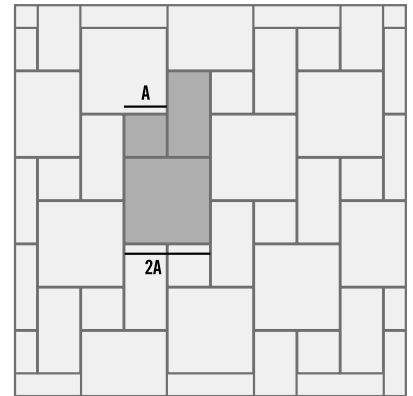

2Ax2A 57%
Ax2A 29%
AxA 14%

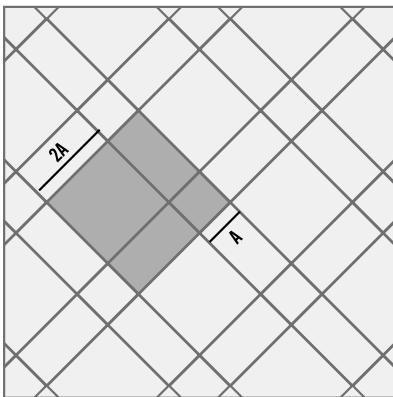

2Ax2A 44,5%
Ax2A 44,5%
AxA 11%

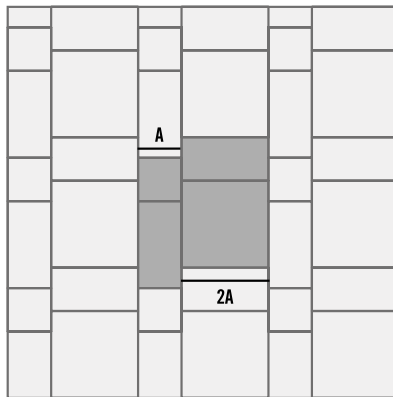

2Ax2A 44,5%
Ax2A 44,5%
AxA 11%

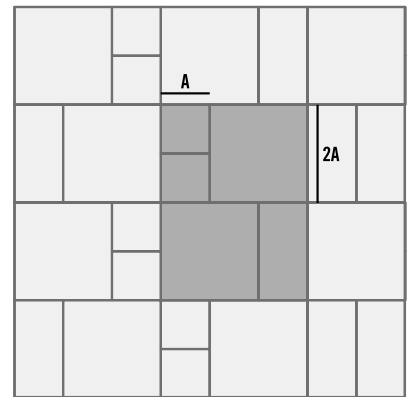

2Ax2A 66%
Ax2A 17%
AxA 17%

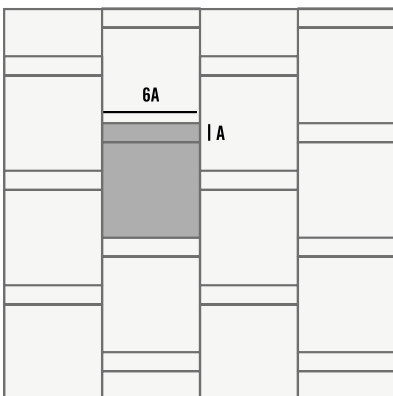

6Ax6A 86%
Ax6A 14%

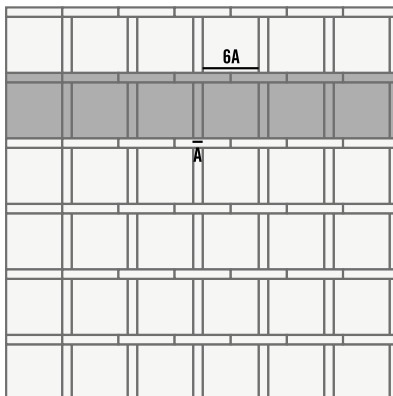

6Ax6A 74%
Ax6A 26%

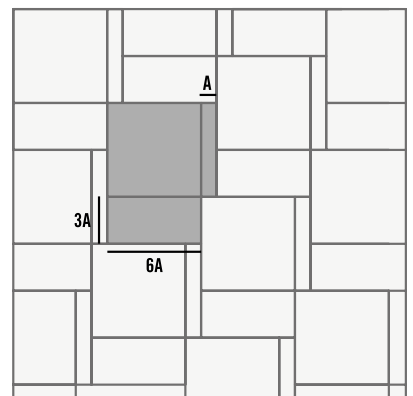

6Ax6A 60%
3Ax6A 30%
Ax6A 10%